

FILTROS Y AUTOPARTES JOE

VIOLETA # 1132 COL. QUINTA VELARDE
GUADALAJARA, JAL. C.P. 44430

TEL: (0133) 3619 6262. 3650 2272 Y 3619 4071

www.filtrosjoe.com

e-mail: ventas@filtrosjoe.com

e-mail: filtrosjoe@gmail.com

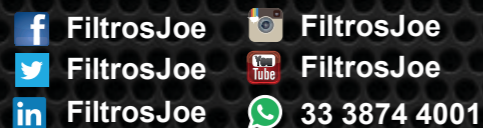

CATALOGO FILTROS ACEITE 2019



**FILTROS Y
AUTOPARTES**

www.filtrosjoe.com

INDICE

03	AUDI
04	BMW
05	BUICK
05	CADILLAC
06	CHEVROLET
09	CHRYSLER
10	DODGE
13	ESTERLING
13	FIAT
13	FORD
15	FREIGHTLINE
15	GEO
16	GMC
16	HONDA
17	HUMMER
18	HYUNDAI
18	INFINITI
19	ISUZU
19	JAGUAR
19	JEEP
21	KIA
21	LAND ROVER
22	LEXUS
22	LINCOLN
23	MAZDA
24	MERCEDES BENZ
25	MERCURY
25	MINI
26	MITSUBISHI
26	NISSAN
27	OLDSMOBILE
28	PEUGEOT
28	PONTIAC
30	PORSCHE
30	RENAULT
31	SAAB
31	SATURN
32	SEAT
32	SMART
33	SUBARU
33	SUZUKI
34	TOYOTA
35	VOLKSWAGEN
37	VOLVO



ROSCA M18 X 1.5

JS2870			
SELLADO			
AUDI A3 MOD.97-04,A4 MOD.98-05, TT MOD.00-04			
FRAM	PH2870A	LTH	LTH28
GONHER	GP28	MANN	W719/5
INTERFIL	OF2870	SKY	N/A



D/V ROSCA M18 X 1.5

JS2870 D/V			
SELLADO			
AUDI A3 MOD. 97-04, A4 MOD. 98-05, TT MOD. 00-04, DOBLE VALVULA			
FRAM	PH2870A	LTH	N/A
GONHER	GP28	MANN	ML2000
INTERFIL	OF2870D	SKY	NA



ROSCA 3/4 - 16

OF2870STX			
SELLADO SINTETICO			
AUDI A3 MOD.97-04,A4 MOD.98-05, TT MOD.00-04			
FRAM	XG2870A	LTH	N/A
GONHER	GP28SNG	MANN	N/A
INTERFIL	N/A	SKY	N/A

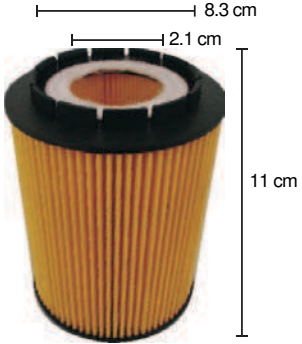

JE8158			
CARTUCHO			
AUDI A8, QUATTRO, S8 Y Q7 MOTOR 3.6 Y 4.2 LTS V6 Y V8 ,01 - 10			
FRAM	CH8158	LTH	N/A
GONHER	G112	MANN	HU932/6N
INTERFIL	OF8158	SKY	N/A

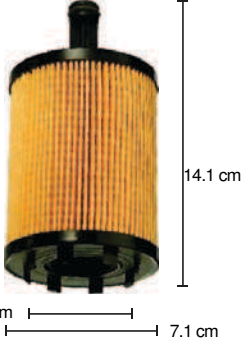

JE9461			
CARTUCHO			
AUDI A3, QUATTRO, 2.0 LTS 4 CIL. DIESEL 3.2 V6 04 - 12			
FRAM	CH9461	LTH	N/A
GONHER	G70	MANN	HU719/7X
INTERFIL	OF9461	SKY	N7A

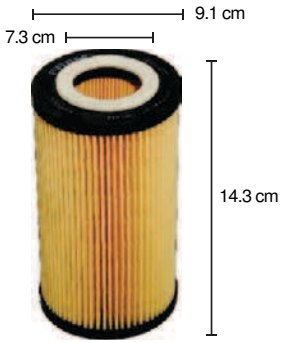

JE9690			
CARTUCHO			
AUDI A 4 , A 6 Y A 8 4.2 LTS. 04 - 08			
FRAM	CH9690	LTH	N/A
GONHER	N/A	MANN	N/A
INTERFIL	N/A	SKY	N/A



JE9706			
CARTUCHO			
AUDI A3 1.4 LTS 03 - 09			
FRAM	N/A	LTH	N/A
GONHER	G562	MANN	HU712/6X
INTERFIL	OF3C11	SKY	N/A

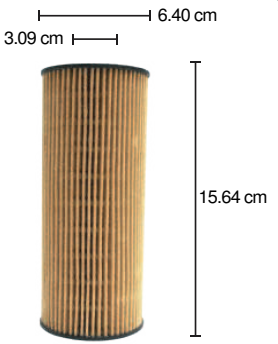

JE10160			
CARTUCHO			
AUDI A4, A4 QUATTRO, A5, A6 , Q5 , Q7,			
FRAM	CH10160	LTH	N/A
GONHER	N/A	MANN	HU722Z
INTERFIL	OF10160	SKY	N/A



ROSCA M22 X 1.5

JS10600			
SELLADO			
AUDI A4, A4 QUATTRO, A5, A6 , Q3 , Q5			
FRAM	PH10600	LTH	N/A
GONHER	G407	MANN	W719/45
INTERFIL	OF5403	SKY	N/A



JE10632			
CARTUCHO			
AUDI A6 QUATRO, A8 Y Q 7 2.4 LTS. V-8 07 - 13			
FRAM	CH10632	LTH	N/A
GONHER	N/A	MANN	HU718/8X
INTERFIL	OF10632	SKY	N/A



JS10757			
SELLADO			
AUDI A1			
FRAM	PH10757	LTH	N/A
GONHER	GP561	MANN	W712/94
INTERFIL	OF6103	SKY	N/A



JE5320			
CARTUCHO			
BMW SERIES 300, 500 M Y Z MOTOR 2.5 LTS. 6 CIL. 91 - 06			
FRAM	CH5320	LTH	N/A
GONHER	G936	MANN	N/A
INTERFIL	N/A	SKY	N/A

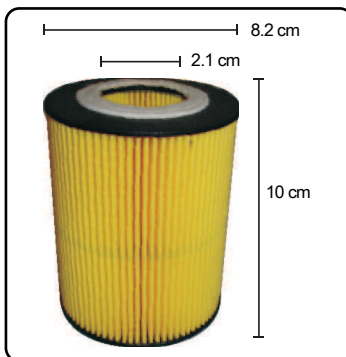

JE8081			
CARTUCHO			
BMW SERIE 300 Y SERIE 500 Y SERIE 5 X 5 3.0 LTS. 6 CIL. 98 - 06			
FRAM	CH8081	LTH	N/A
GONHER	G954	MANN	HU925/4X
INTERFIL	OF8081	SKY	N/A

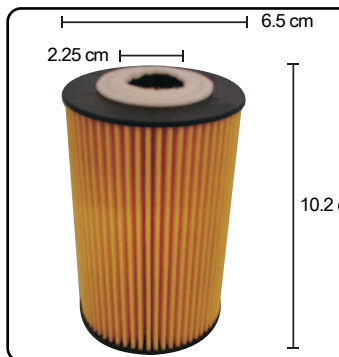

JE8087			
CARTUCHO			
BMW SERIE 300 Y SERIE Z 1.9 LTS. 4 CIL. 96 - 99			
FRAM	CH8087	LTH	N/A
GONHER	G975	MANN	HU715/4X
INTERFIL	OF8087	SKY	N/A

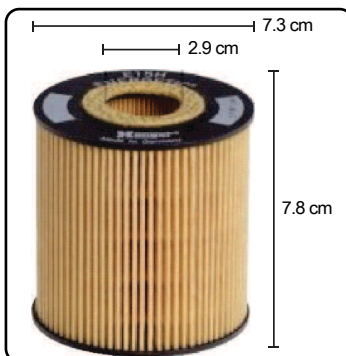

JE9348			
CARTUCHO			
BMW SERIE 3, 5 Y 7, X 5			
FRAM	CH9348	LTH	N/A
GONHER	N/A	MANN	N/A
INTERFIL	N/A	SKY	N/A

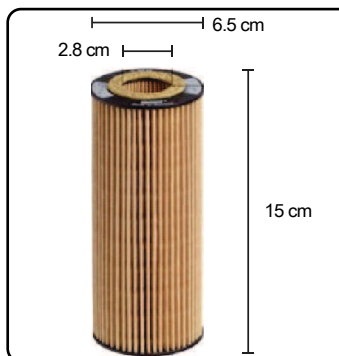

JE9528			
CARTUCHO			
BMW SERIE 3 320 Y BMW TOURING 6 CIL. 98 - 05			
FRAM	CH9528	LTH	N/A
GONHER	N/A	MANN	N/A
INTERFIL	N/A	SKY	N/A

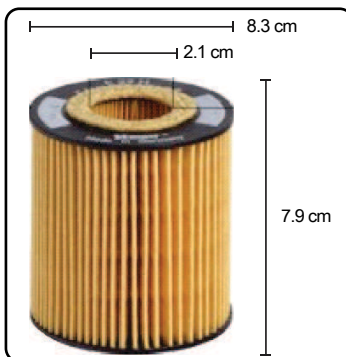

JE9547			
CARTUCHO			
BMW SERIE 3 COMPACT, CONVERTIBLE, COUPE TOURING X 3 Y Z 4 02 - 08			
FRAM	CH9547	LTH	N/A
GONHER	N/A	MANN	N/A
INTERFIL	N/A	SKY	N/A



JE10075			
CARTUCHO			
BMW 325, 328 330 335 X 3, X 5 Y X 7 3.1 LTS. 6 CIL. 06 - 10			
FRAM	CH10075	LTH	N/A
GONHER	N/A	MANN	HU816X
INTERFIL	OF10075	SKY	N/A

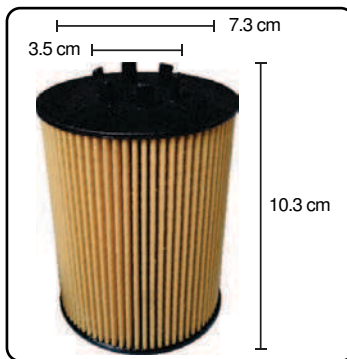

JE10530			
CARTUCHO			
BMW SERIES 300 , 500 Y 700 4.8 Y 6.0 LTS. 03 - 10			
FRAM	CH10530	LTH	N/A
GONHER	N/A	MANN	HU715/15X
INTERFIL	OF10530	SKY	N/A



51223XP			
CARTUCHO SINTETICO			
BMW SERIE 300, SERIE 500, SERIE 5X5 3.0 LTS. 6 CIL. 98 06			
FRAM	XG8081	LTH	N/A
GONHER	G954	MANN	HU925/3X
INTERFIL	OF8081	SKY	N/A



57327XP			
CARTUCHO SINTETICO			
BMW 325,328,330, X 3, X 5, X 7, 3.1 LTS. 6 CIL. 06 - 10			
FRAM	XG10075	LTH	N/A
GONHER	N/A	MANN	N/A
INTERFIL	N/A	SKY	N/A



BUICK



JS3506			
SELLADO			
CENTURY, ELECTRA 78 - 84, LESABRE 76 - 86 ,REGAL 75 - 87, RENDEZVOUS 05,			
FRAM	PH3506	LTH	LTH44
GONHER	GP44 GP3675	MANN	ML1013
INTERFIL	OF3506	SKY	N/A



JS3506STX			
SELLADO SINTETICO			
CENTURY, ELECTRA 78 - 84, LESABRE 76 - 86 ,REGAL 75 - 87, RENDEZVOUS 05,			
FRAM	XG3506	LTH	N/A
GONHER	N/A	MANN	N/A
INTERFIL	N/A	SKY	N/A



Cadillac



57090XP			
CARTUCHO SINTETICO			
CADILLAC CTS, SRX,.			
FRAM	XG8765	LTH	N/A
GONHER	N/A	MANN	N/A
INTERFIL	N/A	SKY	N/A



JS3506			
SELLADO			
DEVILLE, 77 - 05, EL DORADO ,77 - 96 , ESCALADE 02 - 05, CTS, 04 - 05, CTS-V 06, SRX 04, SEVILLE 79 - 04			
FRAM	PH3506	LTH	LTH44
GONHER	GP44 GP3675	MANN	ML1013
INTERFIL	OF3506	SKY	N/A



OF3506STX			
SELLADO SINTETICO			
DEVILLE, 77 - 05, EL DORADO ,77 - 96 , ESCALADE 02 - 05, CTS, 04 - 05, CTS-V 06, SRX 04, SEVILLE 79 - 04			
FRAM	XG3506	LTH	N/A
GONHER	N/A	MANN	N/A
INTERFIL	N/A	SKY	N/A



ROSCA 13/ 16-16

OF3675STX			
SELLADO SINTETICO			
ESCALADE MOD. 02 - 06, V8 6.0 LTS			
FRAM	XG3506	LTH	N/A
GONHER	N/A	MANN	N/A
INTERFIL	N/A	SKY	N/A

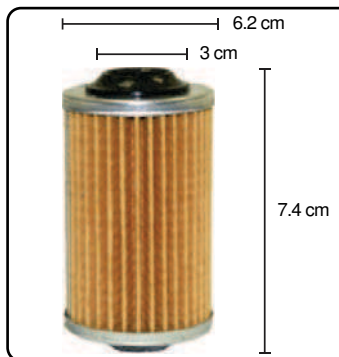

JE8765			
CARTUCHO			
CADILLAC CTS, SRX			
FRAM	CH8765	LTH	N/A
GONHER	N/A	MANN	N/A
INTERFIL	N/A	SKY	N/A



JE8806			
CARTUCHO			
CADILLAC CATERA			
FRAM	CH8806	LTH	N/A
GONHER	N/A	MANN	N/A
INTERFIL	N/A	SKY	N/A

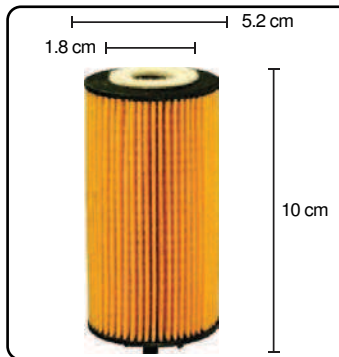

JE9447			
CARTUCHO			
CADILLAC CTS 3.2 LTS. V - 6 03 - 04			
FRAM	CH9447	LTH	N/A
GONHER	N/A	MANN	N/A
INTERFIL	N/A	SKY	N/A



ROSCA 22/ 1.5

JS10060			
SELLADO			
ESCALADE			
FRAM	PH10060	LTH	LTH406
GONHER	GP406	MANN	ML1030
INTERFIL	OF10060	SKY	SKOD2046

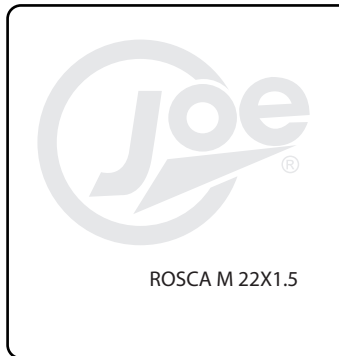

ROSCA M 22X1.5

OF10060STX			
SELLADO			
ESCALADE			
FRAM	PH10060	LTH	N/A
GONHER	GP406	MANN	N/A
INTERFIL	OF10060	SKY	N/A



ROSCA 22/ 1.5

JS10575			
SELLADO			
ESCALADE, CTS, CT6, SRX, XT5,XTS			
FRAM	PH10575	LTH	N/A
GONHER	GP405	MANN	N/A
INTERFIL	OF10575	SKY	N/A



ROSCA M22 X 1.5

OF10575STX			
SELLADO SINTETICO			
ESCALADE, CTS, CT6, SRX, XT5,XTS			
FRAM	XG10575	LTH	N/A
GONHER	GP405SNG	MANN	N/A
INTERFIL	N/A	SKY	N/A



ROSCA 13/ 16-16

JS13			
SELLADO			
CHEYENNE 400 SS, SILVERADO, SUBURBAN, CARGO VAN			
FRAM	PH13	LTH	LTH13
GONHER	GP13	MANN	ML1011
INTERFIL	OF13	SKY	





FRAM PH30
OIL FILTER
FILTRO DE ACEITE
48-2518

ROSCA 13/ 16-16

PH30			
SELLADO			
CAMARO Z28 V8 94-97, CORVETTE 91, MONTECARLO 81-84, SILVERADO 95-98, SUBURBAN 89-98, PICK UP V8 5.7 85-98, PICK UP V6 4.8 81-91			
FRAM	PH30	LTH	LTH30
GONHER	GP3	MANN	W936/5
INTERFIL	OF30	SKY	N/A



OIL FILTER
FILTRO DE ACEITE
48-2518
2518B18
GP-409
OF-2518

ROSCA M18 X 1.5

JS2518			
SELLADO			
CHEVROLET SPARK 1.2 LTS MOD. 11 - 13			
FRAM	PH11462	LTH	N/A
GONHER	GP409	MANN	W6021
INTERFIL	OF2518	SKY	N/A



Interfil OF2951STX
SYNTHETIC OIL
ACEITE SINTETICO

ROSCA 3/4 - 16

OF2951STX			
SELLADO SINTETICO			
CHEVROLET TRACKER MOD. 01 - 04 V6 2.5 LTS			
FRAM	XG2951	LTH	N/A
GONHER	N/A	MANN	N/A
INTERFIL	N/A	SKY	N/A



OIL FILTER
FILTRO DE ACEITE
48-2370

ROSCA M18 X 1.5

JS3387			
SELLADO			
CHEVY, CORSA, TORNADO, CAVALIER, ASTRA, IMPALA, MALIBU, BLAZER, MERIVA, S10, EQUINOX, TORNADO, UPLANDER, VENTURE, ZAFIRA MOD. 90 - 07,			
FRAM	PH3387A	LTH	LTH46
GONHER	GP46	MANN	ML1000
INTERFIL	OF3387	SKY	SKOL2008



Interfil OF3387STX
SYNTHETIC OIL
ACEITE SINTETICO

ROSCA 13/ 16-16

OF3387STX			
SELLADO SINTETICO			
CHEVY, CORSA, TORNADO, CAVALIER, ASTRA, IMPALA, MALIBU, BLAZER, MERIVA, S10, EQUINOX, TORNADO, UPLANDER, VENTURE,			
FRAM	N/A	LTH	N/A
GONHER	N/A	MANN	N/A
INTERFIL	OF3387STX	SKY	N/A



ROSCA M22 X 1.5

JS429			
SELLADO			
COLORADO MOD. 08 - 12 4 CIL. 2.9 LTS. EXPRESS 2500 / 3500 VAN MOD. 05 - 06 V8 6.0 LTS.			
FRAM	PH3429	LTH	N/A
GONHER	GP3429	MANN	N/A
INTERFIL	N/A	SKY	N/A



OIL FILTER
FILTRO DE ACEITE
48-3506
3506D30
PH3506
LTH-44
GP-44
OF-3506

ROSCA 13/ 16-16

JS3506			
SELLADO			
AVALANCHE 02 - 06, COLORADO 04 - 09, EXPRESS VAN 03 - 06, IMPALA 80 - 06, SILVERADO 99 - 06 TRAILBLAZER 02 - 06, TAHOE 02 - 06, MALIBU 82 - 01, C10 79 - 81, C 1500, C 2500, SSR 03 - 06, CORVETTE 97 - 06			
FRAM	PH3506	LTH	LTH44
GONHER	GP44 GP3675	MANN	ML1013
INTERFIL	OF3506	SKY	N/A



Interfil OF3506STX
SYNTHETIC OIL
ACEITE SINTETICO

ROSCA 13/ 16-16

OF3506STX			
SELLADO SINTETICO			
AVALANCHE 02 - 06, COLORADO 04 - 09, EXPRESS VAN 03 - 06, IMPALA 80 - 06, SILVERADO 99 - 06 TRAILBLAZER 02 - 06, TAHOE 02 - 06, MALIBU 82 - 01, C10 79 - 81, C 1500, C 2500, SSR 03 - 06, CORVETTE 97 - 06			
FRAM	XG3506	LTH	N/A
GONHER	N/A	MANN	N/A
INTERFIL	OF3506STX	SKY	N/A



OIL FILTER
FILTRO DE ACEITE
48-3593A
PH3593A
LTH-6811
GP-6811
OF-3593

ROSCA M20 X 1.5

JS3593A			
SELLADO			
LUV 99 - 04.			
FRAM	PH3593A	LTH	LTH6811
GONHER	GP6811	MANN	ML1002
INTERFIL	OF3593H	SKY	N/A



Interfil OF3593HSTX
SYNTHETIC OIL
ACEITE SINTETICO

ROSCA 3/4 - 16

OF3593HSTX			
SELLADO SINTETICO			
CHEVROLET LUV			
FRAM	XG3506	LTH	N/A
GONHER	N/A	MANN	N/A
INTERFIL	N/A	SKY	N/A



ROSCA 13/ 16-16

OF3675STX			
SELLADO SINTETICO			
CHEVROLET SUBURBAN 5.3 LTS. MOD.03 - 08 CHEVROLET TRAIL BLAZER MOD. 02 - 08 6 CIL 4.2 LTS.			
FRAM	XG3675	LTH	N/A
GONHER	N/A	MANN	N/A
INTERFIL	N/A	SKY	N/A



ROSCA M18 X 1.5

JS3980			
SELLADO			
Blazer, Chevy Van, Corvette, Cavalier, Celebrity			
FRAM	PH3980	LTH	LTH3980
GONHER	GP3980 GP3535	MANN	ML1007
INTERFIL	OF3980	SKY	N/A



ROSCA 3/4 - 16

JS4386			
SELLADO			
CHEVROLET TRACKER			
FRAM	PH4386	LTH	LTH156
GONHER	GP156	MANN	ML1017
INTERFIL	OF4386	SKY	SKO12330



ROSCA 3/4 - 16

OF4386STX			
SELLADO SINTETICO			
CHEVROLET TRACKER			
FRAM	XG4386	LTH	N/A
GONHER	GP156SNG	MANN	N/A
INTERFIL	N/A	SKY	N/A



ROSCA 3/4 X 16

JS4967			
SELLADO			
CHEVROLET TRACKER			
FRAM	PH4967	LTH	LTH157
GONHER	GP157	MANN	ML1009
INTERFIL	OF4967	SKY	SKO72412



ROSCA 3/4 - 16

OF4967STX			
SELLADO SINTETICO			
CHEVROLET TRACKER			
FRAM	XG4967	LTH	N/A
GONHER	N/A	MANN	N/A
INTERFIL	N/A	SKY	N/A



ROSCA M20 X 1.5

JS7317			
SELLADO			
CHEVROLET LUV			
FRAM	PH7317	LTH	LTH149
GONHER	GP149	MANN	ML1000
INTERFIL	OF3593	SKY	SKOH7047

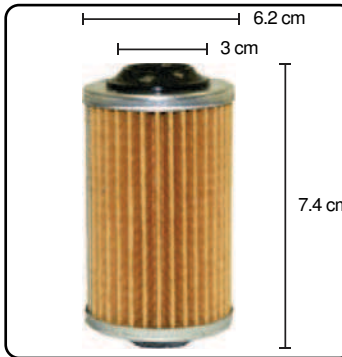

JE8765			
CARTUCHO			
CAMARO			
FRAM	CH8765	LTH	N/A
GONHER	G765	MANN	N/A
INTERFIL	OF8765	SKY	N/A



JE8806			
CARTUCHO			
ASTRA , MALIBU			
FRAM	CH8806	LTH	N/A
GONHER	G45	MANN	ML1028
INTERFIL	OF8806	SKY	N/A



JE9018			
CARTUCHO			
ASTRA , ZAFIRA , VECTRA , H H R , MALIBU , G - 6			
FRAM	CH9018	LTH	N/A
GONHER	G49	MANN	HU69/2X
INTERFIL	OF9018	SKY	N/A



ROSCA 13/16 - 16

OF9100STX			
SELLADO SINTETICO			
SILVERADO 1500 - 3500 V8 6.6 LTS . 06 - 15			
FRAM	XG9100	LTH	N/A
GONHER	N/A	MANN	N/A
INTERFIL	N/A	SKY	N/A



ROSCA M22 X 1.5

JS10060			
SELLADO			
AVALANCHE, COLORADO, CORVETTE, EQUINOX, VAN EXPRESS, SILVERADO, SUBURBAN, TAHOE,			
FRAM	PH10060	LTH	LTH406
GONHER	GP406	MANN	ML1030
INTERFIL	OF10060	SKY	SKOD2046

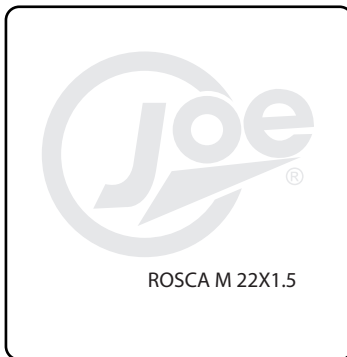

ROSCA M 22X1.5

OF10060STX			
SELLADO			
AVALANCHE, COLORADO, CORVETTE, EQUINOX, VAN EXPRESS, SILVERADO, SUBURBAN, TAHOE,			
FRAM	PH10060	LTH	N/A
GONHER	GP406	MANN	N/A
INTERFIL	OF10060	SKY	N/A

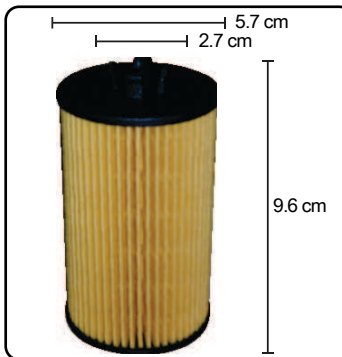

JE10246			
CARTUCHO			
CHEVROLET AVEO, CRUZE, SONIC			
FRAM	CH10246	LTH	N/A
GONHER	G3751	MANN	HU612/2X
INTERFIL	OF10246	SKY	N/A



ROSCA M22 X 1.5

JS10575			
SELLADO			
CAMARO, CAPTIVA SPORT, EQUINOX, VAN EXPRESS 2500, 3500, IMPALA, SILVERADO 1500, SUBURBAN, TAHOE, TRAVERSE			
FRAM	PH10575	LTH	N/A
GONHER	GP405	MANN	N/A
INTERFIL	OF10575	SKY	N/A



ROSCA M22 X 1.5

OF10575STX			
SELLADO SINTETICO			
CAMARO, CAPTIVA SPORT, EQUINOX, VAN EXPRESS 2500, 3500, IMPALA, SILVERADO 1500, SUBURBAN, TAHOE, TRAVERSE			
FRAM	XG10575	LTH	N/A
GONHER	GP405SNG	MANN	N/A
INTERFIL	N/A	SKY	N/A



57082XP			
CARTUCHO SINTETICO			
ASTRA, ZAFIRA, VECTRA, HHR, MALIBU,			
FRAM	XG9018	LTH	N/A
GONHER	N/A	MANN	HU 69/2X
INTERFIL	OF9018	SKY	N/A



57090XP			
CARTUCHO SINTETICO			
CAMARO			
FRAM	XG8765	LTH	N/A
GONHER	N/A	MANN	N/A
INTERFIL	N/A	SKY	N/A



ROSCA 3/4 - 16

JS16			
SELLADO			
CHRYSLER 6 Y 8 CIL-CIRRUS LXI, VIPER, CONCORDE, LHS, SEBRING, VOYAGER 91 TOWN AND COUNTRY, CORDOBA, 300, PACIFICA, ASPEN			
FRAM	PH43	LTH	LTH81
GONHER	GP9	MANN	ML1001
INTERFIL	OF16	SKY	N/A



ROSCA 3/4 - 16

OF16STX			
SELLADO SINTETICO			
CHRYSLER 6 Y 8 CIL-CIRRUS LXI, VIPER, CONCORDE,LHS, SEBRING, VOYAGER 91 TOWN AND COUNTRY, CORDOBA , 300, PACIFICA, ASPEN			
FRAM	XG16	LTH	N/A
GONHER	GP81SGN	MANN	N/A
INTERFIL	N/A	SKY	N/A



ROSCA 3/4 X 16

JS3614			
SELLADO			
PHANTOM, LE BARON, NEW YORKER, PT CRUISER			
FRAM	PH3614	LTH	LTH58
GONHER	GP58	MANN	ML1030
INTERFIL	OF3614	SKY	SKOD2039



ROSCA 3/4 - 16

OF3614STX			
SELLADO SINTETICO			
PHANTOM, LE BARON, NEW YORKER, PT CRUISER			
FRAM	N/A	LTH	N/A
GONHER	GP58SNG	MANN	N/A
INTERFIL	N/A	SKY	N/A



JE8481			
CARTUCHO			
MERCEDES CROSSFIRE , SPRINTER , SERIES CLASS 2.5 , 2.8 , 3.0 Y 4.3 LTS.			
FRAM	CH8481	LTH	N/A
GONHER	G180	MANN	HU18/5X
INTERFIL	OF8481	SKY	N/A

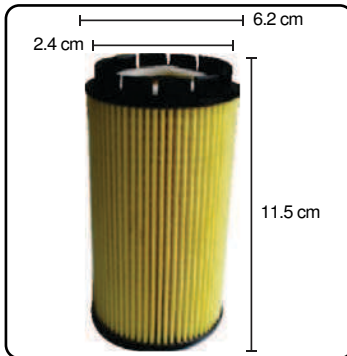

JE9685			
CARTUCHO			
CHRYSLER ,VOYAGER III			
FRAM	CH9685	LTH	N/A
GONHER	N/A	MANN	N/A
INTERFIL	N/A	SKY	N/A



JE10955			
CARTUCHO			
300 C, TOWN COUNTRY			
FRAM	CH10955	LTH	N/A
GONHER	G3744	MANN	HU6009Z
INTERFIL	OF10955	SKY	N/A

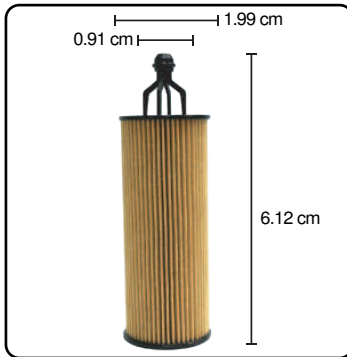

JE11665			
CARTUCHO			
CHRYSLER 200,300 TOWN & COUNTRY			
FRAM	CH11665	LTH	N/A
GONHER	G349	MANN	N/A
INTERFIL	OF11665	SKY	N/A



51226XP			
CARTUCHO SINTETICO			
CROSS FIRE			
FRAM	XG8481	LTH	N/A
GONHER	G180	MANN	HU718/4
INTERFIL	OF8481	SKY	N/A



ROSCA 3/4 - 16

JS16			
SELLADO			
DURANGO 98, RAM CHARGER, STRATUS,CARAVAN.SUPER BEE,INTREPID, LEBARON			
FRAM	PH43	LTH	LTH81
GONHER	GP9	MANN	ML1001
INTERFIL	OF16	SKY	N/A



ROSCA 3/4 - 16

OF16STX			
SELLADO SINTETICO			
DURANGO 98, RAM CHARGER, STRATUS, CARAVAN. SUPER BEE, INTREPID, LEBARON			
FRAM	XG16	LTH	N/A
GONHER	GP81SNG	MANN	N/A
INTERFIL	N/A	SKY	N/A



ROSCA M20 X 1.5

JS3593A			
SELLADO			
STRATUS 001 - 05, STEALTH 91 - 96, COLT- IMPORT 91 -92, H100 MEXICANA 03 - 14.			
FRAM	PH3593A	LTH	LTH6811
GONHER	GP6811	MANN	ML1002
INTERFIL	OF3593H	SKY	N/A



ROSCA 3/4 - 16

OF3593HSTX			
SELLADO SINTETICO			
STRATUS 001 - 05, STEALTH 91 - 96, COLT- IMPORT 91 -92, H100 MEXICANA 03 - 14.			
FRAM	XG3506	LTH	N/A
GONHER	N/A	MANN	N/A
INTERFIL	N/A	SKY	N/A



ROSCA 20x1.5

OF3593STX			
CARTUCHO			
STRATUS 001 - 05, STEALTH 91 - 96, COLT- IMPORT 91 -92, H100 MEXICANA 03 - 14.			
FRAM	PH3593A	LTH	N/A
GONHER	N/A	MANN	N/A
INTERFIL	N/A	SKY	N/A



ROSCA 3/4 X 16

JS3614			
SELLADO			
DART K, SPIRIT, SHADOW, LE BARON, NEON, LIBERTY, VOYAGER, STRATUS, MODELOS K,			
FRAM	PH3614	LTH	LTH58
GONHER	GP58	MANN	ML1030
INTERFIL	OF3614	SKY	SKOD2039



ROSCA 3/4 - 16

OF3614STX			
SELLADO SINTETICO			
DART K, SPIRIT, SHADOW, LE BARON, NEON, LIBERTY, VOYAGER, STRATUS, MODELOS K,			
FRAM	N/A	LTH	N/A
GONHER	GP58SNG	MANN	N/A
INTERFIL	N/A	SKY	N/A



ROSCA 1 - 16

OF3976STX			
SELLADO SINTETICO			
DODGE RAM 1500 - 3500 MOD. 11 - 14 6 CIL. 6.7 LTS. TURBO DIESEL, DODGE RAM 4000 MOD. 03 - 09 V6 5.9 LTS. TURBO DIESEL, DODGE RAM MOD. 11 - 13 6 CIL. 6.7 LTS. TURBO DIESEL			
FRAM	XG3976A	LTH	N/A
GONHER	N/A	MANN	N/A
INTERFIL	N/A	SKY	N/A



8.2 cm

JE6818			
CARTUCHO			
DODGE RAM 700, NEON NUEVO DODGE VISION			
FRAM	N/A	LTH	N/A
GONHER	N/A	MANN	N/A
INTERFIL	N/A	SKY	N/A



ROSCA M20 X 1.5

JS7317			
SELLADO			
NISSAN TSURU III, D21, NP-300, ALTIMA, INFINITI, MAXIMA SE-R, FRONTIER, PATHFINDER, ALTIMA, SENTRA, QUEST, TITAN, URVAN, XTERRA, MDX, RL, TL, CHEVROLET LUV, ACCORD, CIVIC, CR-V, PILOT, ECLIPSE, ENDEAVOR, GALANT, MAZDA SERIES B, ISUZU RODEO, TROOPER, IMPULSE, MITSUBISHI LANCER.			
FRAM	PH-7317	LTH	LTH-149
GONHER	GP-149	MANN	N/A
INTERFIL	OF-7317	SKY	N/A



11.3 cm

JE9301			
CARTUCHO			
DODGE SPRINTER 2.7 LTS. DIESEL 5 CIL. 02 - 06			
FRAM	CH9301	LTH	N/A
GONHER	G918	MANN	HU718/1K
INTERFIL	OF9301	SKY	N/A

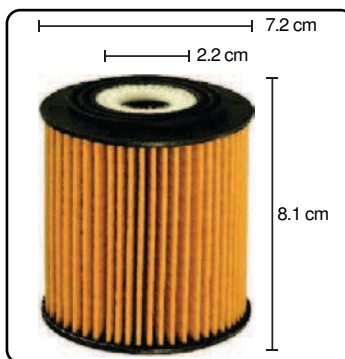

JE9584			
CARTUCHO			
RAM 700,SLT,ST, CLUB ADVENTURE, VICION			
FRAM	CH9584	LTH	N/A
GONHER	N/A	MANN	HU816/2X
INTERFIL	OF9584	SKY	N/A

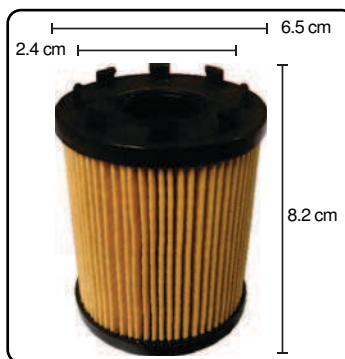

JE9713			
CARTUCHO			
DODGE DART			
FRAM	N/A	LTH	N/A
GONHER	N/A	MANN	HU713/1X
INTERFIL	OF7300	SKY	N/A



JS10060			
SELLADO			
CALIBER			
FRAM	PH10060	LTH	LTH406
GONHER	GP406	MANN	ML1030
INTERFIL	OF10060	SKY	SKOD2046

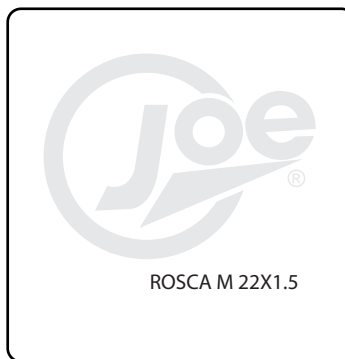

OF10060STX			
SELLADO			
CALIBER			
FRAM	PH10060	LTH	N/A
GONHER	GP406	MANN	N/A
INTERFIL	OF10060	SKY	N/A

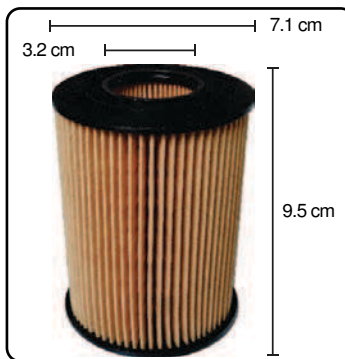

JE10323			
CARTUCHO			
DODGE (AMBULANCIAS)			
FRAM	CH10323	LTH	N/A
GONHER	N/A	MANN	N/A
INTERFIL	N/A	SKY	N/A



JS10575			
SELLADO			
DAKOTA, DURANGO, RAM 1500			
FRAM	PH10575	LTH	N/A
GONHER	GP405	MANN	N/A
INTERFIL	OF10575	SKY	N/A



OF10575STX			
SELLADO SINTETICO			
DAKOTA, DURANGO, RAM 1500			
FRAM	XG10575	LTH	N/A
GONHER	GP405SNG	MANN	N/A
INTERFIL	N/A	SKY	N/A



JE10955			
CARTUCHO			
AVENGER, CHALLENGER, CHARGER, CARAVAN, DURANGO			
FRAM	CH10955	LTH	N/A
GONHER	G3744	MANN	HU6009Z
INTERFIL	OF10955	SKY	N/A

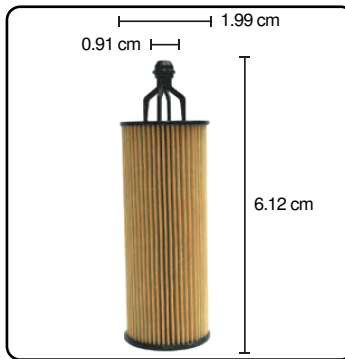

JE11665			
CARTUCHO			
AVENGER CHALLENGER, CHARGER, DURANGO JOURNEY			
FRAM	CH11665	LTH	N/A
GONHER	G349	MANN	N/A
INTERFIL	OF11665	SKY	N/A





JE9558			
CARTUCHO			
ESTERLING WESTERN STAR			
FRAM	CH9558	LTH	N/A
GONHER	G2109	MANN	HU12110X
INTERFIL	OF9558	SKY	N/A



JE6818			
CARTUCHO			
FIAT PALIOT 1.6 LTS. 4 CIL. 15 - 18			
FRAM	N/A	LTH	N/A
GONHER	N/A	MANN	N/A
INTERFIL	N/A	SKY	N/A



OF9011STX			
SELLADO SINTETICO			
FIAT DUCATO MOD.09 4 CIL.2.3 LTS / 3.0 LTS .DIESEL			
FRAM	N/A	LTH	N/A
GONHER	N/A	MANN	N/A
INTERFIL	OF9011STX	SKY	N/A



SOF-4-2354			
SELLADO MINERAL			
FIAT DUCATO MOD.09 4 CIL.2.3 LTS / 3.0 LTS .DIESEL			
FRAM	N/A	LTH	N/A
GONHER	N/A	MANN	N/A
INTERFIL	N/A	SKY	N/A

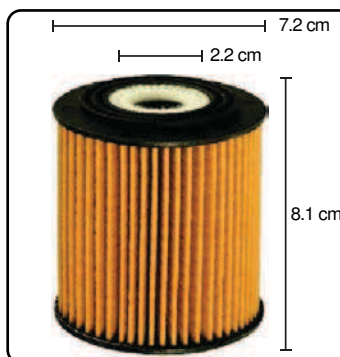

JE9584			
CARTUCHO			
PALIO, ESSENCE,STRADA ADVENTURE, STRADA TREKKING.			
FRAM	CH9584	LTH	N/A
GONHER	N/A	MANN	HU816/2X
INTERFIL	OF9584	SKY	N/A

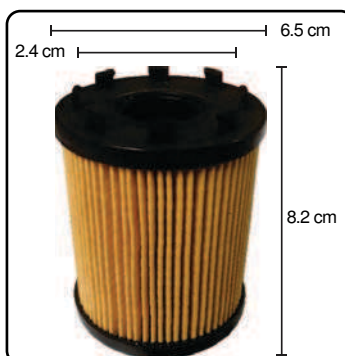

JE9713			
CARTUCHO			
FIAT LINEA 1.4 LTS. 4 CIL. 16 VALV. 13 - 15			
FRAM	N/A	LTH	N/A
GONHER	N/A	MANN	HU713/1X
INTERFIL	OF7300	SKY	N/A



JS2			
SELLADO			
FORD - GRAND MARQUIS 92- FUSION V6, THUNDERBIRD,COUGAR, ECONOLINE V8, ESCAPE V6, FIVE HUNDRED 07, EXCURSION, EXPEDITION, PICK UP V8 Y V10			
FRAM	PH2	LTH	LTH68
GONHER	GP68	MANN	ML1006
INTERFIL	OF2	SKY	N/A



OF2STX			
SELLADO SINTETICO			
FORD - GRAND MARQUIS 92- FUSION V6, THUNDERBIRD,COUGAR, ECONOLINE V8, ESCAPE V6, FIVE HUNDRED 07, EXCURSION, EXPEDITION, PICK UP V8 Y V10			
FRAM	XG2	LTH	N/A
GONHER	GP68SNG	MANN	N/A
INTERFIL	N/A	SKY	N/A



ROSCA 3/4 - 16

JS8			
SELLADO			
FORD MUSTANG, AEROSTAR, BRONCO, EXPLORER, PICK UP, F-150, 250, 350, GRAND MARQUIS 91 Y ANTERIORES LINCOLN- TOWN CAR , CONTINENTAL 97 Y ANTERIORES			
FRAM	PH8	LTH	LTH1
GONHER	GP1	MANN	ML1006
INTERFIL	OF8	SKY	N/A

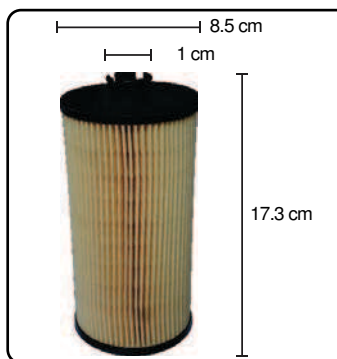

JE105			
CARTUCHO			
FORD SERIES F-150, 250, 350, 450 Y 550 , EXCURSION 6,0 LTS. TURBO DIESEL 03 AL 14			
FRAM	CH9549	LTH	N/A
GONHER	G3752	MANN	ML1034
INTERFIL	OF9549	SKY	N/A



ROSCA 3/4 X 16

JS3600			
SELLADO			
FORD TODO V6 4.0LTS AEROSTAR, COURIER, ECOSPORT, EDGE, ESCORT, FREESTAR, KIA 2.3LTS Y 3.0LTS, IKON, RANGER, LOBO 4.6L, TAURUS, THUNDERBIRD, WINDSTAR,			
FRAM	PH3600	LTH	LTH3600
GONHER	GP3600	MANN	ML1005
INTERFIL	OF3600	SKY	SKOJ2114



OF3600STX			
SELLADO SINTETICO			
FORD TODO V6 4.0LTS AEROSTAR, COURIER, ECOSPORT, EDGE, ESCORT, FREESTAR, KIA 2.3LTS Y 3.0LTS, IKON, RANGER, LOBO 4.6L, TAURUS, THUNDERBIRD, WINDSTAR,			
FRAM	XG3600	LTH	N/A
GONHER	GP3600SNG	MANN	N/A
INTERFIL	N/A	SKY	N/A



ROSCA 3/4 X 16

JS3614			
SELLADO			
FOCUS, FIESTA, FIGO FIESTA, FUSION, ECOSPORT, RANGER,			
FRAM	PH3614	LTH	LTH58
GONHER	GP58	MANN	ML1030
INTERFIL	OF3614	SKY	SKOD2039



OF3614STX			
SELLADO SINTETICO			
FOCUS, FIESTA, FIGO FIESTA, FUSION, ECOSPORT, RANGER,			
FRAM	N/A	LTH	N/A
GONHER	GP58SNG	MANN	N/A
INTERFIL	N/A	SKY	N/A



ROSCA M20 X 1.5

JS6607			
SELLADO			
FORD ESCORT			
FRAM	PH6607	LTH	LTH91
GONHER	GP91	MANN	ML1014
INTERFIL	OF6607	SKY	N/A



OF6607STX			
SELLADO			
FORD ESCORT			
FRAM	PH6607	LTH	N/A
GONHER	GP91	MANN	N/A
INTERFIL	OF6607	SKY	N/A



ROSCA 3/4 - 16

OF9566STX			
SELLADO SINTETICO			
ECO SPORT 03 - 15 4 CIL 2.0 LTS. DURATEC, FIESTA 11 - 15 4 CIL. 1.6 LTS.FUSION 05 - 15 4 CIL.			
FRAM	N/A	LTH	N/A
GONHER	N/A	MANN	N/A
INTERFIL	N/A	SKY	N/A

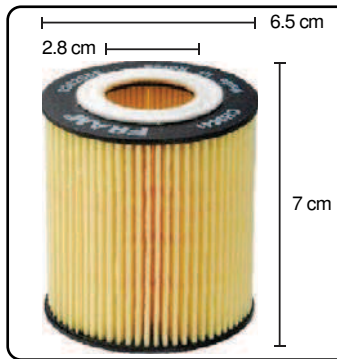

JE9641			
CARTUCHO			
FORD MONDEO FUSION 2.3 LTS. 4 CIL. 06 - 09 ESCAPE			
FRAM	CH9641	LTH	N/A
GONHER	G70	MANN	HU711/2
INTERFIL	OF9641	SKY	N/A



JE10066			
CARTUCHO			
FORD TRANSIT DIESEL 2.2 LTS 4 CIL. 07 - 10			
FRAM	CH10066	LTH	N/A
GONHER	N/A	MANN	HU711X
INTERFIL	OF6744	SKY	N/A



JS10575			
SELLADO			
FORD EDGE, ESCAPE, EXPEDITION, EXPLORER FORD F150, FLEX, FUSION, MUSTANG			
FRAM	PH10575	LTH	N/A
GONHER	GP405	MANN	N/A
INTERFIL	OF10575	SKY	N/A



OF10575STX			
SELLADO SINTETICO			
FORD EDGE, ESCAPE, EXPEDITION, EXPLORER FORD F150, FLEX, FUSION, MUSTANG			
FRAM	XG10575	LTH	N/A
GONHER	GP405SNG	MANN	N/A
INTERFIL	N/A	SKY	N/A



OF10890STX			
SELLADO SINTETICO			
F 150 - 350 V8 6.7 LTS.11 - 15 TURBO DIESEL, F 450 SUPER DUTY V8 6.7 LTS 11 - 15 TURBO DIESEL			
FRAM	N/A	LTH	N/A
GONHER	N/A	MANN	N/A
INTERFIL	N/A	SKY	N/A



57203XP			
CARTUCHO SINTETICO			
MONDEO, FUSION , 2.3 LTS.4 CIL. ESCAPE			
FRAM	XG9641	LTH	N/A
GONHER	N/A	MANN	HU 711 /2
INTERFIL	OF9641	SKY	N/A

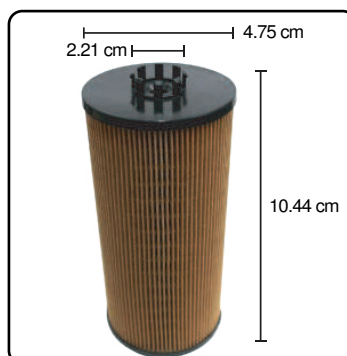

JE9558			
CARTUCHO			
CAMIONES FREIGHTLINER			
FRAM	XG9641	LTH	N/A
GONHER	G2109	MANN	HU12110X
INTERFIL	OF9558	SKY	N/A





JS4386			
SELLADO			
GEO PRIZM			
FRAM	PH4386	LTH	LTH156
GONHER	GP156	MANN	ML1017
INTERFIL	OF4386	SKY	SKO12330





OF4386STX			
SELLADO SINTETICO			
GEO PRIZM			
FRAM	XG4386	LTH	N/A
GONHER	GP156SNG	MANN	N/A
INTERFIL	N/A	SKY	N/A





		JS13			
		SELLADO			
GMC CAMIONETA 7.4L, C-1500,2500,3500 G SERIES,SIERRA PICK UP 6 Y 8 CIL. G 30, VAN G SERIES					
		FRAM	PH13	LTH	LTH13
		GONHER	GP13	MANN	ML1011
		INTERFIL	OF13	SKY	N/A

		PH30			
		SELLADO			
GMC CARGO VAN 97-98,					
		FRAM	PH30	LTH	LTH30
		GONHER	GP3	MANN	W936/5
		INTERFIL	OF30	SKY	N/A

		JS3980			
		SELLADO			
C-15,C1500					
		FRAM	PH3980	LTH	LTH3980
		GONHER	GP3980	MANN	ML1007
		INTERFIL	OF3980	SKY	N/A

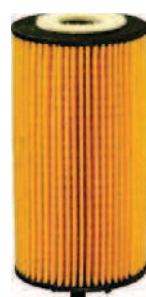
		OF9100STX			
		SELLADO SINTETICO			
TRUCK SAVANA 1500 - 3500 V8 6.6 LTS. DIESEL 06 - 15 SIERRA 1500 - 3500 V8. 6.6 LTS.DIESEL 01 - 15					
		FRAM	XG9100	LTH	N/A
		GONHER	N/A	MANN	N/A
		INTERFIL	N/A	SKY	N/A



	1.8 cm 5.2 cm 10 cm				
	JE9447				
CARTUCHO					
GENERAL MOTORS					
		FRAM	CH9447	LTH	N/A
		GONHER	N/A	MANN	N/A
		INTERFIL	N/A	SKY	N/A

		JS10575			
		SELLADO			
GMC ACADIA, SAVANA, SIERRA, TERRAIN, YUKON					
		FRAM	PH10575	LTH	N/A
		GONHER	GP405	MANN	N/A
		INTERFIL	OF10575	SKY	N/A

		OF10575STX			
		SELLADO SINTETICO			
GMC ACADIA, SAVANA, SIERRA, TERRAIN, YUKON					
		FRAM	XG10575	LTH	N/A
		GONHER	GP405SNG	MANN	N/A
		INTERFIL	N/A	SKY	N/A



HONDA

		JS3593A			
		SELLADO			
ACCORD 84 - 96, ACCORD DX, EX, LX, 94 - 02, ACCORD SE 00 - 02, CIVIC 88 - 97, CIVIC CRX 88 - 91, CIVIC CX, DX, EX, 94 - 00, CIVIC GX, HX, 98 - 00, CIVIC 94 - 00, CIVIC DEL SOL 94 - 97, ODYSSEY 95 - 02, PASSPORT 94 - 02, PRELUDE 83 - 01, CR-V 97 - 01.					
		FRAM	PH3593A	LTH	LTH6811
		GONHER	GP6811	MANN	ML1002
		INTERFIL	OF359H	SKY	N/A



ROSCA 3/4 - 16

OF3593HSTX			
SELLADO SINTETICO			
ACCORD 84 - 96, ACCORD DX, EX, LX, 94 - 02, ACCORD SE 00 - 02, CIVIC 88 - 97, CIVIC CRX 88 - 91, CIVIC CX, DX, EX, 94 - 00, CIVIC GX, HX, 98 - 00, CIVIC 94 - 00, CIVIC DEL SOL 94 - 97, ODYSSEY 95 - 02, PASSPORT 94 - 02, PRELUDE 83 - 01, CR-V 97 - 01.			
FRAM	XG3506	LTH	N/A
GONHER	N/A	MANN	N/A
INTERFIL	N/A	SKY	N/A



ROSCA M20 X 1.5

JS6607			
SELLADO			
HONDA CIVIC, ODYSSEY, CRV,			
FRAM	PH6607	LTH	LTH91
GONHER	GP91	MANN	ML1014
INTERFIL	OF6607	SKY	N/A



ROSCA M20 X 1.5

OF6607STX			
SELLADO			
HONDA CIVIC, ODYSSEY, CRV,			
FRAM	PH-7317	LTH	LTH-149
GONHER	GP-149	MANN	N/A
INTERFIL	OF-7317	SKY	N/A



ROSCA M20 X 1.5

JS7317			
SELLADO			
ACCORD, CIVIC, CR-V, PILOT, ECLIPSE, ENDEAVOR, GALANT, MAZDA SERIES B, ISUZU RODEO, TROOPER, IMPULSE, MITSUBISHI LANCER			
FRAM	PH7317	LTH	LTH149
GONHER	GP149	MANN	ML1008
INTERFIL	OF3593	SKY	SKOH7047



JE9305			
CARTUCHO			
HONDA CIVIC 1.7 LTS 16 VALV. DIESEL 01 - 09			
FRAM	CH9305	LTH	N/A
GONHER	N/A	MANN	N/A
INTERFIL	N/A	SKY	N/A

HUMMER



ROSCA 13/ 16-16

JS13			
SELLADO			
HUMMER H1			
FRAM	PH13	LTH	LTH13
GONHER	GP13	MANN	ML1011
INTERFIL	OF13	SKY	N/A



ROSCA 13/ 16-16

JS3429			
SELLADO			
HUMMER H2 MOD. 04 - 05 V8 6.0 LTS.			
FRAM	PH3429	LTH	N/A
GONHER	GP3429	MANN	N/A
INTERFIL	N/A	SKY	N/A



ROSCA 13/ 16-16

JS3506			
SELLADO			
H2 03 - 06, 6.0 LTS			
FRAM	PH3506	LTH	LTH44
GONHER	GP44 GP3675	MANN	ML1013
INTERFIL	OF3506	SKY	N/A



ROSCA 13/ 16-16

OF3506STX			
SELLADO SINTETICO			
H2 03 - 06, 6.0 LTS			
FRAM	XG3506	LTH	N/A
GONHER	N/A	MANN	N/A
INTERFIL	N/A	SKY	N/A



ROSCA 13/ 16-16

OF3675STX			
SELLADO SINTETICO			
HUMMER H3 MOD. 08 - 10 5 CIL. 3.7 LTS			
FRAM	XG3675	LTH	N/A
GONHER	N/A	MANN	N/A
INTERFIL	N/A	SKY	N/A



ROSCA 22 X 1.5

JS10060			
SELLADO			
HUMMER H2			
FRAM	PH10060	LTH	LTH406
GONHER	GP406	MANN	ML1030
INTERFIL	OF10060	SKY	SKOD2046

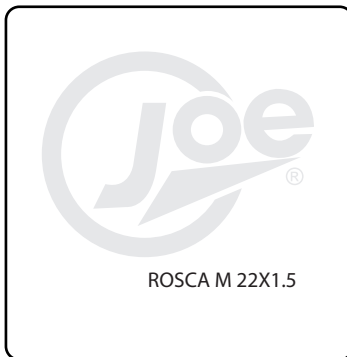

ROSCA M 22X1.5

OF10060STX			
SELLADO			
HUMMER H2			
FRAM	PH10060	LTH	N/A
GONHER	GP406	MANN	N/A
INTERFIL	OF10060	SKY	N/A



HYUNDAI



ROSCA M26 X 1.5

JS112			
SELLADO			
FILTRO ACEITE HYUNDAI H-100 DIESEL 2.5 LTS.			
FRAM	PH10127	LTH	N/A
GONHER	GP112	MANN	N/A
INTERFIL	OF4240	SKY	N/A

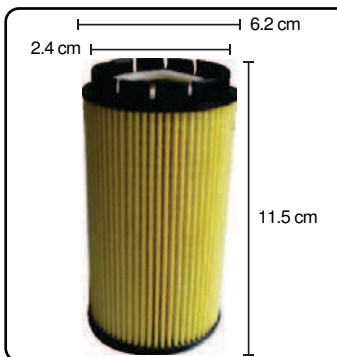

JE9685			
CARTUCHO			
HYUNDAI SANTE FE			
FRAM	CH9685	LTH	N/A
GONHER	N/A	MANN	N/A
INTERFIL	N/A	SKY	N/A



INFINITI



ROSCA M20 X 1.5

JS6607			
SELLADO			
INFINITI			
FRAM	PH6607	LTH	LTH91
GONHER	GP91	MANN	ML1014
INTERFIL	OF6607	SKY	N/A



ROSCA M20 X 1.5

OF6607STX			
SELLADO			
INFINITI			
FRAM	PH6607	LTH	N/A
GONHER	GP91	MANN	N/A
INTERFIL	OF6607	SKY	N/A

ISUZU



JS3593A			
SELLADO			
AMIGO 89 - 00, RODEO 91 - 04, TROOPER 90 - 99, PICKUP 93 - 95. AXIOM 02 - 04, TRUCK 88 - 92, 2.6LT,2.3LT.			
FRAM	PH3593A	LTH	LTH6811
GONHER	GP6811	MANN	ML1002
INTERFIL	OF3593H	SKY	N/A



OF3593HSTX			
SELLADO SINTETICO			
AMIGO 89 - 00, RODEO 91 - 04, TROOPER 90 - 99, PICKUP 93 - 95. AXIOM 02 - 04, TRUCK 88 - 92, 2.6LT,2.3LT.			
FRAM	XG3506	LTH	N/A
GONHER	N/A	MANN	N/A
INTERFIL	N/A	SKY	N/A



JE3753			
CARTUCHO			
ISUZU ELF 200/300 DIESEL TURBO- CARGADOS			
FRAM	N/A	LTH	N/A
GONHER	G3753	MANN	N/A
INTERFIL	OF8980	SKY	N/A



JS7317			
SELLADO			
ISUZU RODEO, TROOPER			
FRAM	PH7317	LTH	LTH149
GONHER	GP149	MANN	ML1008
INTERFIL	OF3593	SKY	SKOH7047



JS3600			
SELLADO			
JAGUAR X TYPE			
FRAM	PH3600	LTH	LTH3600
GONHER	GP3600	MANN	ML1005
INTERFIL	OF3600	SKY	SKOJ2114



OF3600STX			
SELLADO SINTETICO			
JAGUAR X TYPE			
FRAM	XG3600	LTH	N/A
GONHER	GP3600SNG	MANN	N/A
INTERFIL	N/A	SKY	N/A

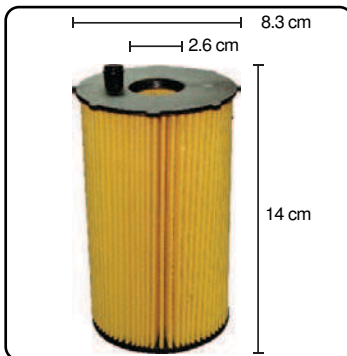

JE10035			
CARTUCHO			
JAGUAR 2.7 LTS. 4 CIL. 02 - 09			
FRAM	N/A	LTH	N/A
GONHER	N/A	MANN	N/A
INTERFIL	N/A	SKY	N/A



JS16			
SELLADO			
JEEP-CHEROKEE, WRANGLER 91 CHEROKEE SPORT			
FRAM	PH43	LTH	LTH81
GONHER	GP9	MANN	ML1001
INTERFIL	OF16	SKY	N/A



ROSCA 3/4 - 16

OF16STX			
SELLADO			
JEEP-CHEROKEE, WRANGLER 91 CHEROKEE SPORT			
FRAM	XG16	LTH	N/A
GONHER	GP81SNG	MANN	N/A
INTERFIL	N/A	SKY	N/A



ROSCA 3/4 X 16

JS3600			
SELLADO			
JEEP LIBERTY MOD. 02 - 08, JEEP GRAND CHEROKEE, JAGUAR X TYPE, SABLE, TOYOTA 4 RUNNER, TACOMA,			
FRAM	PH3600	LTH	LTH3600
GONHER	GP3600	MANN	ML1005
INTERFIL	OF3600	SKY	SKOJ2114



ROSCA 3/4 - 16

OF3600STX			
SELLADO SINTETICO			
JEEP LIBERTY MOD. 02 - 08, JEEP GRAND CHEROKEE, JAGUAR X TYPE, SABLE, TOYOTA 4 RUNNER, TACOMA,			
FRAM	XG3600	LTH	N/A
GONHER	GP3600SNG	MANN	N/A
INTERFIL	N/A	SKY	N/A

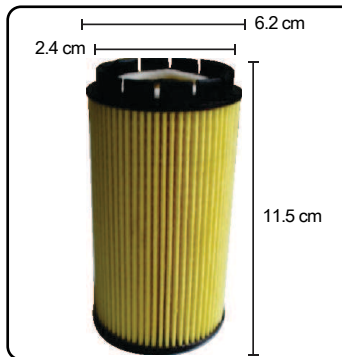

JE9685			
CARTUCHO			
JEEP CHEROKEE			
FRAM	CH9685	LTH	N/A
GONHER	N/A	MANN	N/A
INTERFIL	N/A	SKY	N/A



JE9713			
CARTUCHO			
JEEP RENEGADE			
FRAM	N/A	LTH	N/A
GONHER	N/A	MANN	HU713/1X
INTERFIL	OF7300	SKY	N/A



ROSCA RM 22 X 1.5

JS10060			
SELLADO			
JEEP PATRIOT			
FRAM	PH10060	LTH	LTH406
GONHER	GP406	MANN	ML1030
INTERFIL	OF10060	SKY	SKOD2046

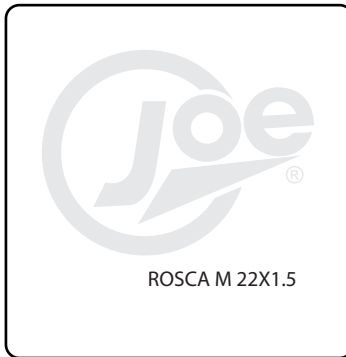

ROSCA M 22X1.5

OF10060STX			
SELLADO			
JEEP PATRIOT			
FRAM	PH10060	LTH	N/A
GONHER	GP406	MANN	N/A
INTERFIL	OF10060	SKY	N/A



ROSCA RM 22 X 1.5

JS10575			
SELLADO			
JEEP COMMANDER, GRAND CHERO- KEE, LIBERTY			
FRAM	PH10575	LTH	N/A
GONHER	GP405	MANN	N/A
INTERFIL	OF10575	SKY	N/A



ROSCA M22 X 1.5

OF10575STX			
SELLADO SINTETICO			
JEEP COMMANDER, GRAND CHERO- KEE, LIBERTY			
FRAM	XG10575	LTH	N/A
GONHER	GP405SNG	MANN	N/A
INTERFIL	N/A	SKY	N/A

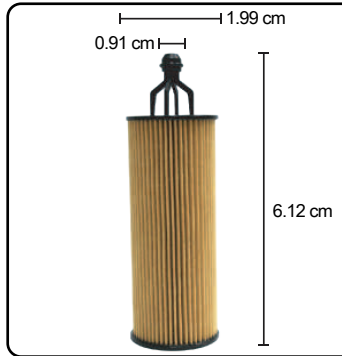

JE11665			
CARTUCHO			
CHEROKEE			
FRAM	CH11665	LTH	N/A
GONHER	G349	MANN	N/A
INTERFIL	OF11665	SKY	N/A

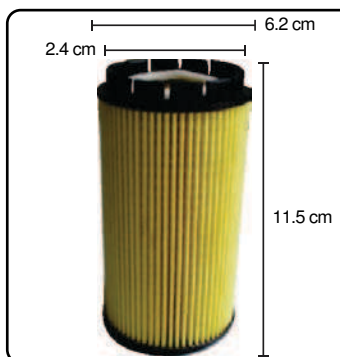

JE9685			
CARTUCHO			
KIA CARENS 02			
FRAM	CH9685	LTH	N/A
GONHER	N/A	MANN	N/A
INTERFIL	N/A	SKY	N/A



JS2			
SELLADO			
LAND ROVER LR3 V6 05			
FRAM	PH2	LTH	LTH68
GONHER	GP68	MANN	ML1006
INTERFIL	OF2	SKY	N/A



OF2STX			
SELLADO SINTETICO			
LAND ROVER LR3 V6 05			
FRAM	XG2	LTH	N/A
GONHER	GP68SNG	MANN	N/A
INTERFIL	N/A	SKY	N/A



JS16			
SELLADO			
LAND ROVER 93 - 16			
FRAM	PH43	LTH	LTH81
GONHER	GP9	MANN	ML1001
INTERFIL	OF16	SKY	N/A



OF16STX			
SELLADO			
LAND ROVER 93 - 16			
FRAM	XG16	LTH	N/A
GONHER	GP81SNG	MANN	N/A
INTERFIL	N/A	SKY	N/A



OF9011STX			
CARTUCHO SINTETICO			
LAND ROVER , FREELANDER Y ROVER 75 98 - 05			
FRAM	N/A	LTH	N/A
GONHER	N/A	MANN	N/A
INTERFIL	N/A	SKY	N/A



JE9011			
CARTUCHO			
LAND ROVER , FREELANDER Y ROVER 75 98 - 05			
FRAM	CH9011	LTH	N/A
GONHER	N/A	MANN	N/A
INTERFIL	N/A	SKY	N/A

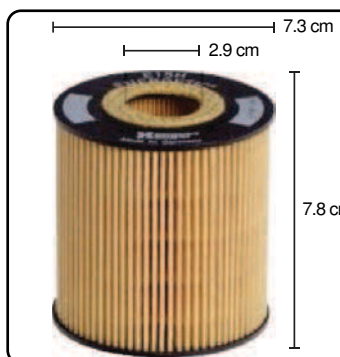

JE9348			
CARTUCHO			
LAND ROVER RANGE ROVER III 03-08			
FRAM	CH9348	LTH	N/A
GONHER	N/A	MANN	N/A
INTERFIL	N/A	SKY	N/A

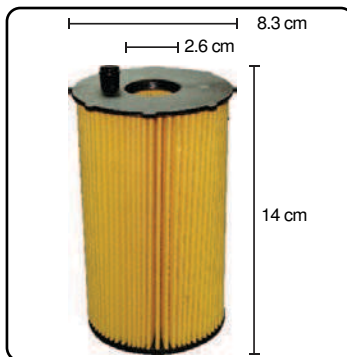

JE10035			
CARTUCHO			
LAND ROVER RANGE ROVER Y DISCOVERY III			
FRAM	N/A	LTH	N/A
GONHER	N/A	MANN	N/A
INTERFIL	N/A	SKY	N/A

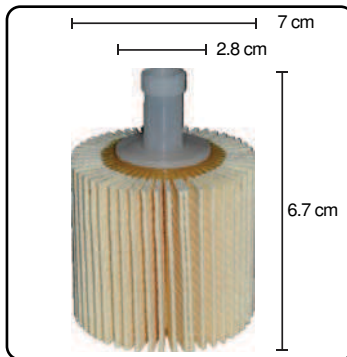

JE9972			
CARTUCHO			
LEXUS ES 350 3.5 LTS. V-6 07 - 10			
FRAM	CH9972	LTH	N/A
GONHER	G912	MANN	ML1031
INTERFIL	OF9972	SKY	N/A

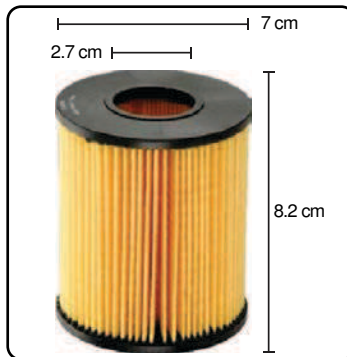

JE10158			
CARTUCHO			
LEXUS GS300, GS350, GS400, 3.0 L Y 3.5			
FRAM	CH10158	LTH	N/A
GONHER	N/A	MANN	N/A
INTERFIL	N/A	SKY	N/A



57047XP			
CARTUCHO SINTETICO			
LEXUS ES 350 3.5 LTS. V-6 07 - 10			
FRAM	XG9972	LTH	N/A
GONHER	N/A	MANN	N/A
INTERFIL	N/A	SKY	N/A



L I N C O L N



JS2			
SELLADO			
LINCOLN -NAVIGATOR 00-, TOWN CAR 91-, AVIATOR 03-, CONTINENTAL 95			
FRAM	PH2	LTH	LTH68
GONHER	GP68	MANN	ML1006
INTERFIL	OF2	SKY	N/A



OF2STX			
SELLADO SINTETICO			
LINCOLN -NAVIGATOR 00-, TOWN CAR 91-, AVIATOR 03-, CONTINENTAL 95			
FRAM	XG2	LTH	N/A
GONHER	GP68SNG	MANN	N/A
INTERFIL	N/A	SKY	N/A



JS8			
SELLADO			
LINCOLN- TOWN CAR , CONTINENTAL 97 Y ANTERIORES			
FRAM	PH8	LTH	LTH-1
GONHER	GP1	MANN	ML1004
INTERFIL	OF8	SKY	N/A



JS10575			
SELLADO			
LINCOLN, CONTINENTAL, NAVIGATOR			
FRAM	PH10575	LTH	N/A
GONHER	GP405	MANN	N/A
INTERFIL	OF10575	SKY	N/A



ROSCA M22 X 1.5

OF10575STX			
SELLADO SINTETICO			
LINCOLN, CONTINENTAL, NAVIGATOR			
FRAM	XG10575	LTH	N/A
GONHER	GP405SNG	MANN	N/A
INTERFIL	N/A	SKY	N/A



mazda



ROSCA M22 X 1.5

JS2			
SELLADO			
MAZDA MPV 00, MAZDA 6, V6 03			
FRAM	PH2	LTH	LTH68
GONHER	GP68	MANN	ML1006
INTERFIL	OF2	SKY	N/A



ROSCA M22 X 1.5

OF2STX			
SELLADO SINTETICO			
MAZDA MPV 00, MAZDA 6, V6 03			
FRAM	XG2	LTH	N/A
GONHER	GP68SNG	MANN	N/A
INTERFIL	N/A	SKY	N/A



ROSCA M20 X 1.5

JS3593A			
SELLADO			
MAZDA 626, 83 - 92, B2200 87 - 92, MPV 89 - 92, B2000 86 - 87, MX6 88 - 92, MAZDA 929 88 - 92, RX7 80 - 89			
FRAM	PH3593A	LTH	LTH6811
GONHER	GP6811	MANN	ML1002
INTERFIL	OF3593H	SKY	N/A



ROSCA 3/4 - 16

OF3593HSTX			
SELLADO SINTETICO			
MAZDA 626, 83 - 92, B2200 87 - 92, MPV 89 - 92, B2000 86 - 87, MX6 88 - 92, MAZDA 929 88 - 92, RX7 80 - 89			
FRAM	XG3506	LTH	N/A
GONHER	N/A	MANN	N/A
INTERFIL	N/A	SKY	N/A



ROSCA M20 X 1.5

JS7317			
SELLADO			
MAZDA SERIES B			
FRAM	PH7317	LTH	LTH149
GONHER	GP149	MANN	ML1008
INTERFIL	OF3593	SKY	SKOH7047



ROSCA 3/4 - 16

OF9566STX			
SELLADO SINTETICO			
MX - 5, 06 - 15 4 CIL. 2.0 LTS.			
FRAM	N/A	LTH	N/A
GONHER	N/A	MANN	N/A
INTERFIL	N/A	SKY	N/A

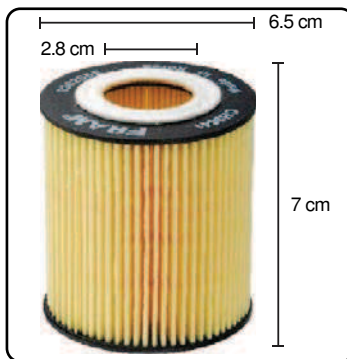

JE9641			
CARTUCHO			
MAZDA 3, 5 Y 6 2.3 Y 2.5			
FRAM	CH9641	LTH	N/A
GONHER	G70	MANN	HU711/2
INTERFIL	OF9641	SKY	N/A



57203XP			
CARTUCHO SINTETICO			
MAZDA 3, 5, 6, 2.3 2.5, LTS.06 - 09			
FRAM	XG9641	LTH	N/A
GONHER	N/A	MANN	HU 711 /2
INTERFIL	OF9641	SKY	N/A



Mercedes-Benz

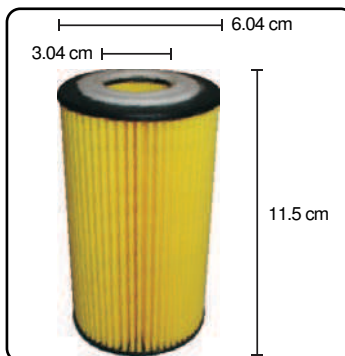

JE8481			
CARTUCHO			
MERCEDE, SPRINTER, SERIES CLASS 2.5, 2.8, 3.0 Y 4.3 LTS.			
FRAM	CH8481	LTH	N/A
GONHER	G180	MANN	HU718/5X
INTERFIL	OF8481	SKY	N/A



JE6848			
CARTUCHO			
MERCEDES BENZ SERIE 300 CLASS MOTOR 2.8, 3.0 Y 3.2 LTS. 4 Y 6CIL. 94 - 04			
FRAM	CH6848	LTH	N/A
GONHER	G971	MANN	N/A
INTERFIL	OF6848	SKY	N/A

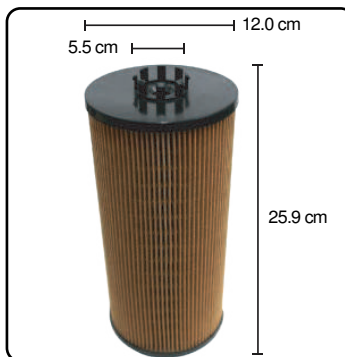

JE9558			
CARTUCHO			
MERCEDES BENZ AXOR CAMION			
FRAM	CH9558	LTH	N/A
GONHER	G2109	MANN	HU12110X
INTERFIL	OF9558	SKY	N/A

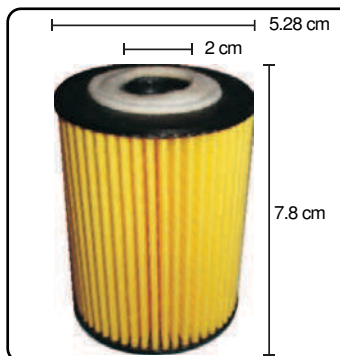

JE8776			
CARTUCHO			
MERCEDES CLASE A - 160, A - 190 4 CIL. 1.6 Y 1.9 00-04			
FRAM	CH8776	LTH	N/A
GONHER	G910	MANN	HU610X
INTERFIL	OF8776	SKY	N/A



JE9918			
CARTUCHO			
MERCEDES C CLASS 1.8 LTS 16 VAL. 03 - 05			
FRAM	CH9918	LTH	N/A
GONHER	N/A	MANN	HU514X
INTERFIL	OF9918	SKY	N/A

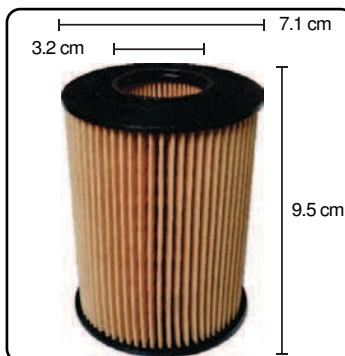

JE10323			
CARTUCHO			
SPRINTER 3.0 LTS. V - 6 DIESEL TURBO 07 - 13 (AMBULANCIAS)			
FRAM	CH10323	LTH	N/A
GONHER	N/A	MANN	N/A
INTERFIL	N/A	SKY	N/A



JE11473			
CARTUCHO			
FILTRO ACEITE MERCEDES BENZ B250, C300, C350E, CLA250, E300, GLA250, METRIZ SLC300 2.0 LTS. 4CIL. 15-19			
FRAM	CH11743	LTH	N/A
GONHER	N/A	MANN	HU711/6Z
INTERFIL	N/A	SKY	N/A





51226XP			
CARTUCHO SINTETICO			
SPRINTER, SERIES CLASS 2.5, 2.8, 3.0, 4.3 LTS, 98 - 08			
FRAM	XG8481	LTH	N/A
GONHER	G180	MANN	HU 718/4
INTERFIL	OF8481	SKY	N/A



MERCURY

 <p>ROSCA M22 X 1.5</p>	JS2			
	SELLADO			
	MERCURY MILAN, MONTEGO 05- , MARINER V6, MOUNTANIEER 02			
	FRAM	PH2	LTH	LTH68
	GONHER	GP68	MANN	ML1006
	INTERFIL	OF2	SKY	N/A

 <p>ROSCA M22 X 1.5</p>	OF2STX			
	SELLADO SINTETICO			
	MERCURY MILAN, MONTEGO 05- , MARINER V6, MOUNTANIEER 02			
	FRAM	XG2	LTH	N/A
	GONHER	GP68SNG	MANN	N/A
	INTERFIL	N/A	SKY	N/A

 <p>ROSCA 3/4 X 16</p>	JS3600			
	SELLADO			
	SABLE			
	FRAM	PH3600	LTH	N/A
	GONHER	GP3600	MANN	ML1005
	INTERFIL	OF3600	SKY	SKOJ2114

 <p>ROSCA 3/4 - 16</p>	OF3600STX			
	SELLADO SINTETICO			
	SABLE			
	FRAM	XG3600	LTH	N/A
	GONHER	GP3600SNG	MANN	N/A
	INTERFIL	N/A	SKY	N/A

 <p>ROSCA 3/4 X 16</p>	JS3614			
	SELLADO			
	MILAN, MARINER			
	FRAM	PH3614	LTH	LTH58
	GONHER	GP58	MANN	ML1030
	INTERFIL	OF3614	SKY	SKOD2039

 <p>ROSCA 3/4 - 16</p>	OF3614STX			
	SELLADO SINTETICO			
	MILAN, MARINER			
	FRAM	N/A	LTH	N/A
	GONHER	GP58SNG	MANN	N/A
	INTERFIL	N/A	SKY	N/A



	JE9584			
	CARTUCHO			
	MINI COPPER 02 - 08			
	FRAM	CH9584	LTH	N/A
	GONHER	N/A	MANN	HU816/2X
	INTERFIL	OF9584	SKY	N/A

	JE9973			
	CARTUCHO			
	MINI COOPER, CLUBMAN, COOPER S Y COUNTRYMAN 1.6 LTS 4 CIL. 08 - 12			
	FRAM	N/A	LTH	N/A
	GONHER	G341	MANN	HU711/51X
	INTERFIL	OF11Z1	SKY	N/A



mitsubishi



JS3593A			
SELLADO			
ECLIPSE 00 - 05, GALANT 99 - 03, L200 08 - 13, MONTERO 00 - 03, 300GT 91 - 99, DIAMANTE 92 - 96.			
FRAM	PH3593A	LTH	N/A
GONHER	GP6811	MANN	LYH6811
INTERFIL	OF3593H	SKY	ML1002



OF3593HSTX			
SELLADO SINTETICO			
ECLIPSE 00 - 05, GALANT 99 - 03, L200 08 - 13, MONTERO 00 - 03, 300GT 91 - 99, DIAMANTE 92 - 96.			
FRAM	XG3506	LTH	N/A
GONHER	N/A	MANN	N/A
INTERFIL	N/A	SKY	N/A



JS6607			
SELLADO			
MITSUBISHI ECLIPSE, LANCER, OUTLANDER			
FRAM	PH6607	LTH	LTH91
GONHER	GP91	MANN	ML1014
INTERFIL	OF6607	SKY	N/A



OF6607STX			
SELLADO			
MITSUBISHI ECLIPSE, LANCER, OUTLANDER			
FRAM	PH-7317	LTH	LTH-149
GONHER	GP-149	MANN	N/A
INTERFIL	OF-7317	SKY	N/A



JS7317			
SELLADO			
ECLIPSE, ENDEAVOR, GALANT, LANCER			
FRAM	PH7317	LTH	LTH149
GONHER	GP149	MANN	ML1008
INTERFIL	OF3593	SKY	SKOH7047



JS171			
SELLADO			
FILTRO ACEITE NISSAN NP 300 DIESEL, CABSTAR D-22			
FRAM	N/D	LTH	N/A
GONHER	GP171	MANN	W920/48
INTERFIL	OF1520	SKY	N/A

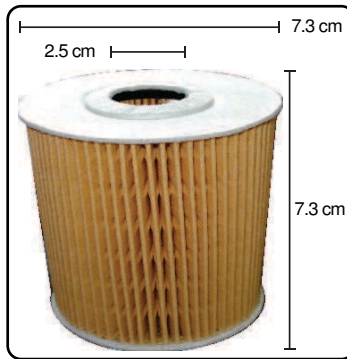

JE200			
CARTUCHO			
NISSAN X TRAIL, PICK-UP D-22 DIESEL 06 - 09 15208-AD200			
FRAM	N/A	LTH	N/A
GONHER	N/A	MANN	HU819/1X
INTERFIL	N/A	SKY	N/A



JS291			
SELLADO			
PLATINA, CLIO, APRIO.			
FRAM	PH10959	LTH	LTH291
GONHER	GP291	MANN	W75/3
INTERFIL	OF4177	SKY	N/A



JS3682			
SELLADO			
NISSAN TSURU II Y TSURU III HIKARI MOD. 88 - 89, NINJA MOD. 87 - 88, GUAYIN MOD. 84 - 89, DATSUN SEDAN, ICHI VAN, LUCINO, MAXIMA, SENTRA, KING CAB PICK UP 2.4 LTS			
FRAM	PH3692	LTH	LTH3682
GONHER	GP3682	MANN	ML1012
INTERFIL	OF3682	SKY	SKO12334



JS4386			
SELLADO			
SENTRA, STURU.			
FRAM	PH4386	LTH	LTH156
GONHER	GP156	MANN	ML1017
INTERFIL	OF4386	SKY	SKO12330



OF4386STX			
SELLADO SINTETICO			
SENTRA, STURU.			
FRAM	XG4386	LTH	N/A
GONHER	GP156SNG	MANN	N/A
INTERFIL	N/A	SKY	N/A



JS4967			
SELLADO			
MICRA, TSURU GSR			
FRAM	PH4967	LTH	LTH157
GONHER	GP157	MANN	ML1009
INTERFIL	OF4967	SKY	SKO72412



OF4967STX			
SELLADO SINTETICO			
MICRA, TSURU GSR			
FRAM	XG4957	LTH	N/A
GONHER	N/A	MANN	N/A
INTERFIL	N/A	SKY	N/A



JS6607			
SELLADO			
JUKE, ROGUE, TIIDA, VERSA, ALMERA, ALTIMA, LUCINO, MAXIMA, SENTRA MURANO ATOS BY DODGE 1.0LTS MITSUBISHI ECLIPSE, LANCER, OUTLANDER, FORD ESCORT, HONDA CIVIC, ODYSSEY, CRV,			
FRAM	PH6607	LTH	LTH91
GONHER	GP91	MANN	ML1014
INTERFIL	OF6607	SKY	N/A



OF6607STX			
SELLADO			
JUKE, ROGUE, TIIDA, VERSA, ALMERA, ALTIMA, LUCINO, MAXIMA, SENTRA MURANO ATOS BY DODGE 1.0LTS MITSUBISHI ECLIPSE, LANCER, OUTLANDER, FORD ESCORT, HONDA CIVIC, ODYSSEY, CRV,			
FRAM	PH6607	LTH	N/A
GONHER	GP91	MANN	N/A
INTERFIL	OF6607	SKY	N/A



JS7317			
SELLADO			
TSURU III, D21, NP-300, ALTIMA, INFINITI, MAXIMA SE-R, FRONTIER, PATHFINDER, ALTIMA, SENTRA, QUEST, TITAN, URVAN, XTERRA, MDX, RL, TL; : ACCORD, CIVIC, CR-V, PILOT, ECLIPSE, ENDEAVOR, GALANT, MAZDA SERIES B, ISUZU RODEO, TROOPER, IMPULSE, MITSUBISHI LANCER			
FRAM	PH7317	LTH	LTH149
GONHER	GP149	MANN	ML1008
INTERFIL	OF3593	SKY	SKOH7047



JE9540			
CARTUCHO			
NISSAN URVAN DDTi DIESEL Y TERRANO II 3.0 LTS. 4 CIL. 08 - 10			
FRAM	CH9540	LTH	N/A
GONHER	N/A	MANN	HU825X
INTERFIL	OF2092	SKY	N/A



Oldsmobile



JS3387			
SELLADO			
CUTLASS, 77 - 99, SILOHUETTE 92 - 02, ALERO 99 - 04			
FRAM	PH3387A	LTH	LTH46
GONHER	GP46	MANN	ML1000
INTERFIL	OF3387	SKY	SKOL2008



ROSCA 13/ 16-16

OF3387STX			
SELLADO SINTETICO			
CUTLASS, 77 - 99 ,SILOHJETTE 92 - 02 ,ALERO 99 - 04			
FRAM	N/A	LTH	N/A
GONHER	N/A	MANN	N/A
INTERFIL	N/A	SKY	N/A



ROSCA M18 X 1.5

JS3980			
SELLADO			
Cutlass, Century			
FRAM	PH3980	LTH	LTH3980
GONHER	GP3980	MANN	ML1007
INTERFIL	OF3980	SKY	N/A



ROSCA M22 X 1.5

JS10575			
SELLADO			
BUICK			
FRAM	PH10575	LTH	N/A
GONHER	GP405	MANN	N/A
INTERFIL	OF10575	SKY	N/A



ROSCA M22 X 1.5

OF10575STX			
SELLADO SINTETICO			
BUICK			
FRAM	XG10575	LTH	N/A
GONHER	GP405SNG	MANN	N/A
INTERFIL	N/A	SKY	N/A



JOF3970			
CARTUCHO			
CENTURY , LUMINA , CUTLASS			
FRAM	CH3970	LTH	N/A
GONHER	G3970	MANN	N/A
INTERFIL	N/A	SKY	N/A



JE9443			
CARTUCHO			
PEUGEOT 206 , GRAND RAID Y PARTNER 4 CIL. 1.4 Y 1.6 LTS. 02 - 09			
FRAM	N/A	LTH	N/A
GONHER	G141	MANN	HU612X
INTERFIL	OF1109	SKY	N/A



JE9657			
CARTUCHO			
PEUGEOT PARTNER DIESEL 4 CIL. 1.6 LTS. 09 - 17			
FRAM	CH9657	LTH	N/A
GONHER	N/A	MANN	N/A
INTERFIL	N/A	SKY	N/A



ROSCA M13/16 -16

PH30			
SELLADO			
PONTIAC FIREBIRD 94-97, PONTIAC TRANS AM, 94-97			
FRAM	PH30	LTH	LTH30
GONHER	GP3	MANN	W936/5
INTERFIL	OF30	SKY	N/A



ROSCA M18 X 1.5

JS3387			
SELLADO			
AZTEC,03 - 05, G3 06 - 08, G6 05- 06, MONTANA 03 - 06,SUNBIRD 76 - 94, TRANS SPORT 92 - 98			
FRAM	PH3387A	LTH	LTH46
GONHER	GP46	MANN	ML1000
INTERFIL	OF3387	SKY	SKOL2008



ROSCA 13/ 16-16

OF3387STX			
SELLADO SINTETICO			
AZTEC,03 - 05, G3 06 - 08, G6 05- 06, MONTANA 03 - 06,SUNBIRD 76 - 94, TRANS SPORT 92 - 98			
FRAM	N/A	LTH	N/A
GONHER	N/A	MANN	N/A
INTERFIL	N/A	SKY	N/A

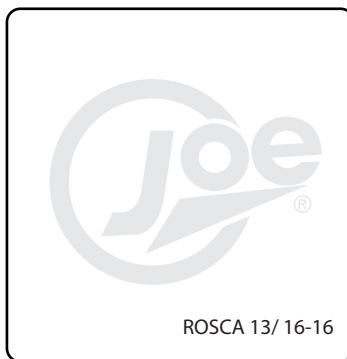

ROSCA 13/ 16-16

JS3429			
SELLADO			
GRAND AM MOD. 99 - 01 4 CIL. 2.4 LTS. SUNFIRE MOD. 96 - 02 4 CIL. 2.4 LTS.			
FRAM	PH3429	LTH	N/A
GONHER	GP3429	MANN	N/A
INTERFIL	N/A	SKY	N/A



ROSCA 13/ 16-16

JS3506			
SELLADO			
GRAN AM 96 - 01, GTO 04 - 06, SUNFIRE 96 - 02, FIREBIRD 77 - 02, GRAND PRIX 77 - 06, BONEVILLE 77 - 05.			
FRAM	PH3506	LTH	LTH44
GONHER	GP44 GP3675	MANN	ML1013
INTERFIL	OF3506	SKY	N/A



ROSCA 13/ 16-16

OF3506STX			
SELLADO SINTETICO			
GRAN AM 96 - 01, GTO 04 - 06, SUNFIRE 96 - 02, FIREBIRD 77 - 02, GRAND PRIX 77 - 06, BONEVILLE 77 - 05.			
FRAM	XG3506	LTH	N/A
GONHER	N/A	MANN	N/A
INTERFIL	N/A	SKY	N/A



ROSCA 3/4-16

JS4386			
SELLADO			
PONTIAC VIBE			
FRAM	PH4386	LTH	LTH156
GONHER	GP156	MANN	ML1017
INTERFIL	OF4386	SKY	SKO12330



ROSCA 3/4 - 16

OF4386STX			
SELLADO SINTETICO			
PONTIAC VIBE			
FRAM	XG4386	LTH	N/A
GONHER	GP156SNG	MANN	N/A
INTERFIL	N/A	SKY	N/A



ROSCA 3/4 X 16

JS4967			
SELLADO			
PONTIAC MATIZ			
FRAM	PH4967	LTH	LTH157
GONHER	GP157	MANN	ML1009
INTERFIL	OF4967	SKY	SKO72412



ROSCA 3/4 - 16

OF4967STX			
SELLADO SINTETICO			
PONTIAC MATIZ			
FRAM	XG4967	LTH	N/A
GONHER	N/A	MANN	N/A
INTERFIL	N/A	SKY	N/A



ROSCA M22 X 1.5

JS10060			
SELLADO			
GRAND PRIX, PONTIAC G6			
FRAM	PH10060	LTH	LTH406
GONHER	GP406	MANN	ML1030
INTERFIL	OF10060	SKY	SKOD2046

ROSCA M 22X1.5

OF10060STX			
SELLADO			
GRAND PRIX, PONTIAC G6			
FRAM	PH10060	LTH	N/A
GONHER	GP406	MANN	N/A
INTERFIL	OF10060	SKY	N/A

JE10246			
CARTUCHO			
PONTIAC G- 3 1.4, 1.6 Y 1.8 LTS. 4 CIL. 09 - 12			
FRAM	CH10246	LTH	N/A
GONHER	G3751	MANN	HU612/2X
INTERFIL	OF10246	SKY	N/A

57082XP			
CARTUCHO SINTETICO			
G6			
FRAM	XG9018	LTH	N/A
GONHER	N/A	MANN	HU 69/2X
INTERFIL	OF9018	SKY	N/A

JOF3970			
CARTUCHO			
PONTIAC GRAND AM TRANSMISION 2.5 LTS. 4 CIL.			
FRAM	CH3970	LTH	N/A
GONHER	G3970	MANN	N/A
INTERFIL	N/A	SKY	N/A



PORSCHE

JE10160			
CARTUCHO			
PORSHE CAYENNE			
FRAM	CH10160	LTH	N/A
GONHER	N/A	MANN	HU722Z
INTERFIL	OF10160	SKY	N/A

JS10600			
SELLADO			
PORSHE CAYENNE			
FRAM	PH10600	LTH	N/A
GONHER	G407	MANN	W719/45
INTERFIL	OF5403	SKY	N/A



RENAULT

JS291			
SELLADO			
RENAUL KANGOO, CLIO, KOLEOS			
FRAM	PH10959	LTH	LTH291
GONHER	GP291	MANN	W75/3
INTERFIL	OF4177	SKY	N/A

JE9437			
CARTUCHO			
RENAULT CLIO II, KANGOO EXPRESS, TWINGO 04-08			
FRAM	CH9437	LTH	N/A
GONHER	N/A	MANN	N/A
INTERFIL	N/A	SKY	N/A

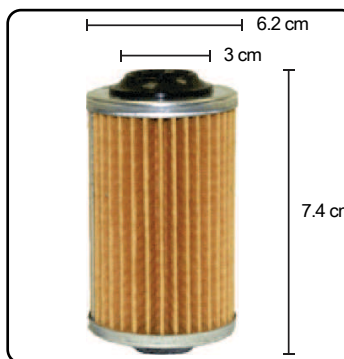

JE8765			
CARTUCHO			
SAAB			
FRAM	CH8765	LTH	N/A
GONHER	G765	MANN	N/A
INTERFIL	OF8765	SKY	N/A

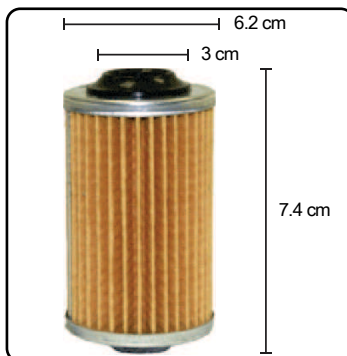

57090XP			
CARTUCHO SINTETECO			
SAAB			
FRAM	XG8765	LTH	N/A
GONHER	N/A	MANN	N/A
INTERFIL	N/A	SKY	N/A



SATURN

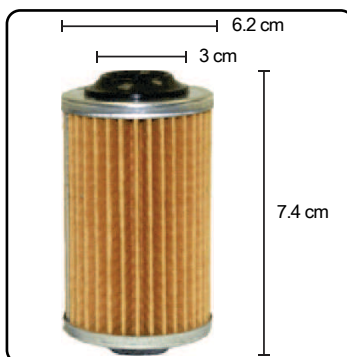

JE8765			
CARTUCHO			
SATURN G-8 V-6 3.5 Y 3.6 LTS.			
FRAM	CH8765	LTH	N/A
GONHER	G765	MANN	N/A
INTERFIL	OF8765	SKY	N/A



JE8806			
CARTUCHO			
SATURN L 300 1.8 Y 3.0 LTS. 24 VAL. 4 Y 6 CIL.			
FRAM	CH8806	LTH	N/A
GONHER	G45	MANN	ML1028
INTERFIL	OF8806	SKY	N/A



JE9018			
CARTUCHO			
SATURN 2.0, 2.2 Y 2.4 LTS. 16 VAL			
FRAM	CH9018	LTH	N/A
GONHER	G49	MANN	HU69/2X
INTERFIL	OF9018	SKY	N/A



JS10060			
SELLADO			
SATURN 4, 6 Y 8 CIL. 07 - 18			
FRAM	PH10060	LTH	LTH406
GONHER	GP406	MANN	ML1030
INTERFIL	OF10060	SKY	SKOD2046

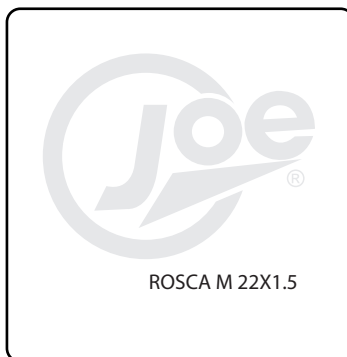

OF10060STX			
SELLADO			
SATURN 2.0, 2.2 Y 2.4 LTS. 16 VAL			
FRAM	PH10060	LTH	N/A
GONHER	GP406	MANN	N/A
INTERFIL	OF10060	SKY	N/A



57082XP			
CARTUCHO SINTETICO			
SATURN 2.0, 2.2, 2.4 LTS. 16 VALV. 98 - 00			
FRAM	XG9018	LTH	N/A
GONHER	N/A	MANN	HU 69/2X
INTERFIL	OF9018	SKY	N/A



57090XP			
CARTUCHO SINTETICO			
G - 8, V - 6,3.5. 3.6 LTS. 04			
FRAM	XG8765	LTH	N/A
GONHER	N/A	MANN	N/A
INTERFIL	N/A	SKY	N/A



JS2870			
SELLADO			
ALHAMBRA MOD. 04-05, CORDOVA MOD. 00-07, IBIZA, LEON, TOLEDO			
FRAM	PH2870A	LTH	LTH28
GONHER	GP28	MANN	W719/5
INTERFIL	OF2870	SKY	N/A



OF2870STX			
CARTUCHO SELLADO			
ALHAMBRA MOD. 04-05, CORDOVA MOD. 00-07, IBIZA, LEON, TOLEDO			
FRAM	XG2870A	LTH	N/A
GONHER	GP28SNG	MANN	N/A
INTERFIL	N/A	SKY	N/A



JS2870 D/V			
SELLADO			
CORDOVA MOD. 00-07, IBIZA, LEON, TOLEDO, DOBLE VALVULA			
FRAM	PH2870A	LTH	N/A
GONHER	GP28	MANN	ML2000
INTERFIL	OF2870D	SKY	N/A

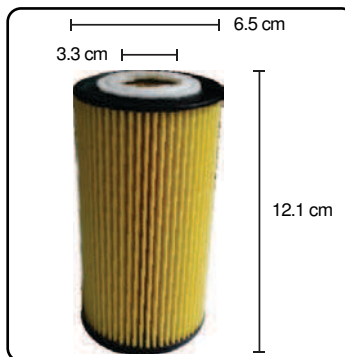

JE9911			
CARTUCHO			
SEAT LEON 1,8 LTS. 4 CIL. 06 - 08			
FRAM	CH9911	LTH	N/A
GONHER	G313	MANN	HU719/6X
INTERFIL	OF5562	SKY	N/A



JS10600			
SELLADO			
SEAT ALTEA SEAT LEON			
FRAM	PH10600	LTH	N/A
GONHER	G407	MANN	W719/45
INTERFIL	OF5403	SKY	N/A



JS10757			
SELLADO			
SEAT			
FRAM	PH10757	LTH	N/A
GONHER	GP561	MANN	W712/94
INTERFIL	OF6103	SKY	N/A

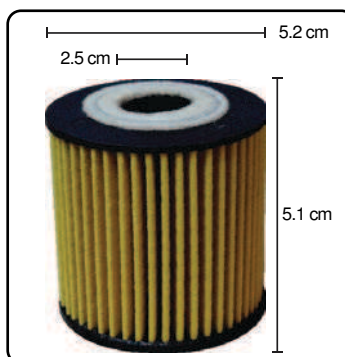

JE9024			
CARTUCHO			
SMART CITY 3 CIL. 0.6 LTS 2001 - 2007			
FRAM	N/A	LTH	N/A
GONHER	N/A	MANN	N/A
INTERFIL	N/A	SKY	N/A



JS3593A			
SELLADO			
LEGACY, IMPREZA			
FRAM	PH3593A	LTH	LTH6811
GONHER	GP6811	MANN	ML1002
INTERFIL	OF3593H	SKY	N/A



OF3593HSTX			
SELLADO SINTETICO			
LEGACY, IMPREZA			
FRAM	XG3506	LTH	N/A
GONHER	N/A	MANN	N/A
INTERFIL	N/A	SKY	N/A



JS2951			
CARTUCHO			
GRAND VITARA 07 - 08 V6 2.7 LTS. VITARA 04 - 05 V6 2.5 LTS.			
FRAM	XG2951	LTH	N/A
GONHER	N/A	MANN	N/A
INTERFIL	N/A	SKY	N/A



OF2951STX			
SELLADO SINTETICO			
GRAND VITARA 07 - 08 V6 2.7 LTS. VITARA 04 - 05 V6 2.5 LTS.			
FRAM	XG2951	LTH	N/A
GONHER	N/A	MANN	N/A
INTERFIL	N/A	SKY	N/A



JS3614			
SELLADO			
GRAND VITARA			
FRAM	PH3614	LTH	LTH58
GONHER	GP58	MANN	ML1030
INTERFIL	OF3614	SKY	SKOD2039



OF3614STX			
SELLADO SINTETICO			
GRAND VITARA			
FRAM	N/A	LTH	N/A
GONHER	GP58SNG	MANN	N/A
INTERFIL	N/A	SKY	N/A



JS4386			
SELLADO			
SUZUKI AERIO, GRAN VITARA, KIZASHI, SAMURAI, SWIFT, SX4, VITARA.			
FRAM	PH4386	LTH	LTH156
GONHER	GP156	MANN	ML1017
INTERFIL	OF4386	SKY	SKO12330



OF4386STX			
SELLADO SINTETICO			
SUZUKI AERIO, GRAN VITARA, KIZASHI, SAMURAI, SWIFT, SX4, VITARA.			
FRAM	XG4386	LTH	N/A
GONHER	GP156SNG	MANN	N/A
INTERFIL	N/A	SKY	N/A



JS4967			
SELLADO			
GRAND VITARA MOD. 01 -08			
FRAM	PH4967	LTH	LTH157
GONHER	GP157	MANN	ML1009
INTERFIL	OF4967	SKY	SKO72412



OF4967STX			
SELLADO SINTETICO			
GRAND VITARA MOD. 01 -08			
FRAM	XG4967	LTH	N/A
GONHER	N/A	MANN	N/A
INTERFIL	N/A	SKY	N/A



JS3600			
SELLADO			
TOYOTA 4 RUNNER, TACOMA,			
FRAM	PH3600GP36	LTH	LTH3600
GONHER	00	MANN	ML1005
INTERFIL	OF3600	SKY	SKOJ2114



OF3600STX			
SELLADO SINTETICO			
TOYOTA 4 RUNNER, TACOMA,			
FRAM	XG3600	LTH	N/A
GONHER	GP3600SNG	MANN	N/A
INTERFIL	N/A	SKY	N/A



JS3614			
SELLADO			
4 RUNNER, CAMRY, COROLLA,			
FRAM	PH3614	LTH	LTH58
GONHER	GP58	MANN	ML1030
INTERFIL	OF3614	SKY	SKOD2039



OF3614STX			
SELLADO SINTETICO			
4 RUNNER, CAMRY, COROLLA,			
FRAM	N/A	LTH	N/A
GONHER	GP58SNG	MANN	N/A
INTERFIL	N/A	SKY	N/A



JS4386			
SELLADO			
CAMRY, CELICA, COROLLA, HIGHLANDER, MATRIX, RAV 4, SOLARA, TOYOTA MONTACARGAS.			
FRAM	PH4386	LTH	LTH156
GONHER	GP156	MANN	ML1017
INTERFIL	OF4386	SKY	SKO12330



OF4386STX			
SELLADO SINTETICO			
CAMRY, CELICA, COROLLA, HIGHLANDER, MATRIX, RAV 4, SOLARA, TOYOTA MONTACARGAS.			
FRAM	PH4386	LTH	N/A
GONHER	GP156SNG	MANN	N/A
INTERFIL	N/A	SKY	N/A



JS4967			
SELLADO			
TOYOTA COROLLA, AVANZA, YARIS,- CAMRY, COROLLA, HIGHLANDER, MATRIX, MR2 SPIDER, RAV 4			
FRAM	PH4967	LTH	LTH157
GONHER	GP157	MANN	ML1009
INTERFIL	OF4967	SKY	SKO72412



OF4967STX			
SELLADO SINTETICO			
TOYOTA COROLLA, AVANZA, YARIS,- CAMRY, COROLLA, HIGHLANDER, MATRIX, MR2 SPIDER, RAV 4			
FRAM	XG4967	LTH	N/A
GONHER	N/A	MANN	N/A
INTERFIL	N/A	SKY	N/A

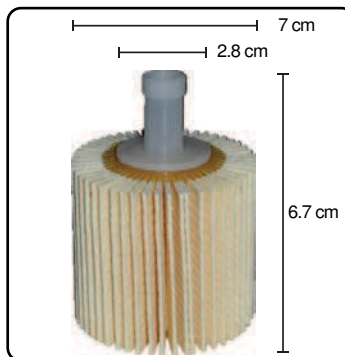

JE9972			
CARTUCHO			
TOYOTA RAV-4 , CAMRY 2.5 4 CIL. V6 3.5 LTS.			
FRAM	CH9972	LTH	N/A
GONHER	G912	MANN	ML1031
INTERFIL	OF9972	SKY	N/A

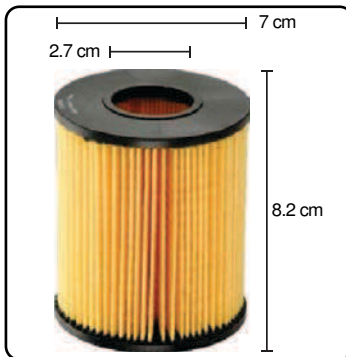

JE10158			
CARTUCHO			
TOYOTA 4 RUNNER, FJ CRUSIER 4.0 LTS V6 ,10			
FRAM	CH10158	LTH	N/A
GONHER	N/A	MANN	N/A
INTERFIL	N/A	SKY	N/A

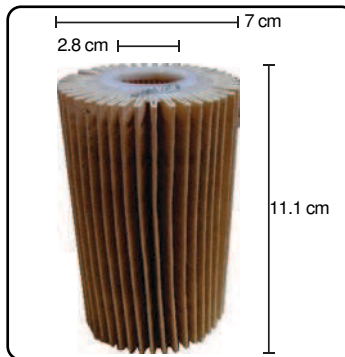

JE10295			
CARTUCHO			
TOYOTA LAND CRUSIER Y TUNDRA 4.6 Y 5.7 LTS. V-8, 07 - 12			
FRAM	CH10295	LTH	N/A
GONHER	G917	MANN	N/A
INTERFIL	OF10295	SKY	N/A

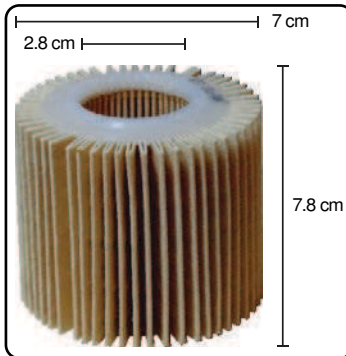

JE10358			
CARTUCHO			
TOYOTA COROLLA, MATRIX Y PRIUS 1.8 LTS.16 VALV. 4 CIL. 09 - 12			
FRAM	CH10358	LTH	N/A
GONHER	G911	MANN	HU6006Z
INTERFIL	OF10358	SKY	N/A

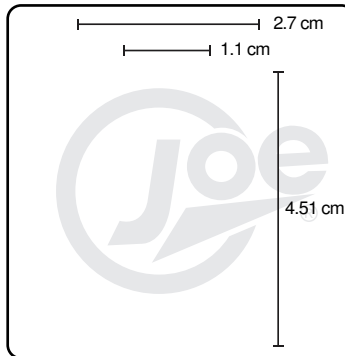

57041XP			
CARTUCHO SINTETICO			
LAND CRUSIER, TUNDRA 4.6 LTS. V-8, 07 - 12			
FRAM	XG10295	LTH	N/A
GONHER	N/A	MANN	ML1046
INTERFIL	OF10295	SKY	N/A



57047XP			
CARTUCHO SINTETICO			
RAV - 4, CAMRY 2.5 4 CIL. V6 3.5 LTS.			
FRAM	XG9972	LTH	N/A
GONHER	N/A	MANN	N/A
INTERFIL	N/A	SKY	N/A



57064XP			
CARTUCHO SINTETICO			
TOYOTA COROLLA, MATRIX, PRIUS, 1.8 LTS. 16 VALV. 4 CIL. 09 - 12			
FRAM	XG10358	LTH	N/A
GONHER	N/A	MANN	N/A
INTERFIL	N/A	SKY	N/A



JS428			
SELLADO			
V.W. POLO, LUPO, SAVEIRO, GOL, SEAT			
FRAM	N/D	LTH	N/A
GONHER	GP428	MANN	W712/52
INTERFIL	OF5548D	SKY	N/A



ROSCA M18 X 1.5

JS2870			
SELLADO			
V.W. GOLF, JETTA SEDAN, ICHI VAN, PICK UP MOD. 79 - 92; BEETLE, COMBI, POLO MOD. 00-07, DERBY, GOLF, JETTA A4, PASAT, POINTER, SHARAN, SEDAN Y VAN			
FRAM	PH2870A	LTH	LTH28
GONHER	GP28	MANN	W719/5
INTERFIL	OF2870	SKY	N/A



ROSCA 3/4 - 16

OF2870STX			
SELLADO SINTETICO			
V.W. GOLF, JETTA SEDAN, ICHI VAN, PICK UP MOD. 79 - 92; BEETLE, COMBI, POLO MOD. 00-07, DERBY, GOLF, JETTA A4, PASAT, POINTER, SHARAN, SEDAN Y VAN			
FRAM	XG2870A	LTH	N/A
GONHER	GP28SNG	MANN	N/A
INTERFIL	N/A	SKY	N/A



JS2870 D/V			
SELLADO			
V.W. GOLF, JETTA SEDAN, ICHI VAN, PICK UP MOD. 79 - 92; BEETLE, COMBI, POLO MOD. 00-07, DERBY, GOLF, JETTA A4, PASAT, POINTER, SHARAN, SEDAN Y VAN, DOBLE VALVULA			
FRAM	PH2870A	LTH	N/A
GONHER	GP28	MANN	ML2000
INTERFIL	OF2870D	SKY	N/A

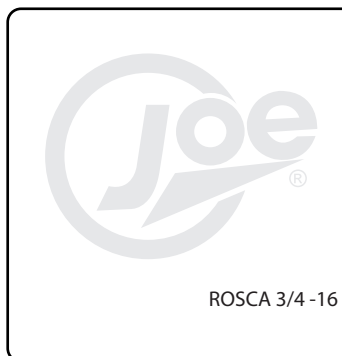

ROSCA 3/4 - 16

OF5548DSTX			
CARTUCHO			
V.W. POLO, LUPO, SAVEIRO, GOL, SEAT			
FRAM	N/A	LTH	N/A
GONHER	GP428	MANN	N/A
INTERFIL	OF5548D	SKY	N/A

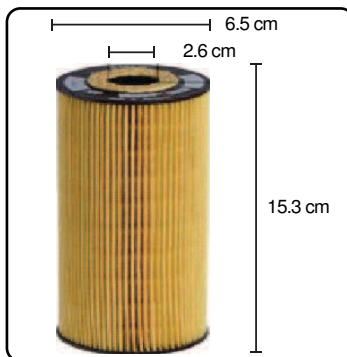

JE530			
CARTUCHO			
BEETLE, CABRIOLET, DIESEL TURBO, SEAT LEON, BORA, GOLF JETTA 1.9 LTS. 4 CIL.			
FRAM	CH8530	LTH	N/A
GONHER	N/A	MANN	HU726/2X
INTERFIL	OF8530	SKY	N/A

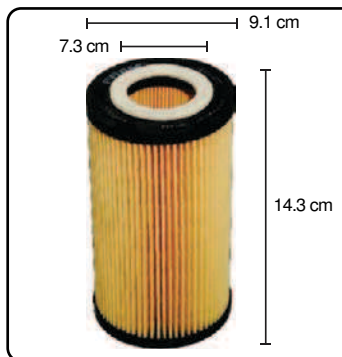

JE9690			
CARTUCHO			
V.W. PEATHON 4.2 LTS. 04 - 08			
FRAM	CH9690	LTH	N/A
GONHER	N/A	MANN	N/A
INTERFIL	N/A	SKY	N/A

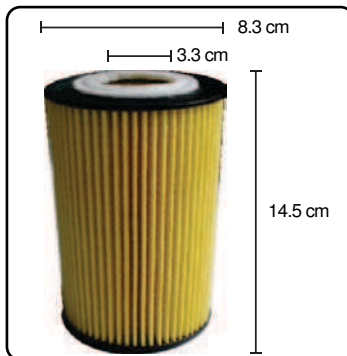

JE9801			
CARTUCHO			
V.W. TOUAREG Y CABRIO 3.0 LTS. V-6 06 - 11			
FRAM	CH9801	LTH	N/A
GONHER	N/A	MANN	N/A
INTERFIL	N/A	SKY	N/A

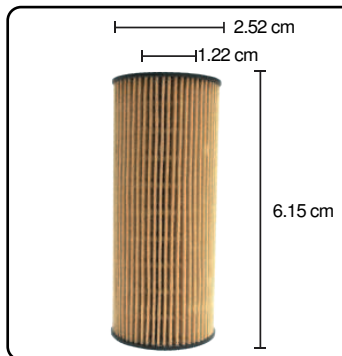

JE10160			
CARTUCHO			
V.W. TOUAREG 3.0, 3.2 Y 3.6 LTS, 06-17			
FRAM	CH10160	LTH	N/A
GONHER	N/A	MANN	HU722Z
INTERFIL	OF10160	SKY	N/A



ROSCA M22 X 1.5

JS10600			
SELLADO			
V.W. BEETLE JETTA, GTI, PASSAT, TIGUAN 2.0 LTS 08 - 18			
FRAM	PH10600	LTH	N/A
GONHER	G407	MANN	W719/45
INTERFIL	OF5403	SKY	N/A



ROSCA N/D

JS10757			
SELLADO			
VENTO V.W. TIGUAN 1.4 LTS 4 CIL. MOD. 11 - 15, POLO 1.2 LTS TSI			
FRAM	PH10757	LTH	N/A
GONHER	GP561	MANN	W712/94
INTERFIL	OF6103	SKY	N/A



JE10759			
CARTUCHO			
V.W. AMAROK TDI , MULTIVAN Y VENTO 1.6 Y 2.0 LTS. DIESEL TURBO 09 - 14			
FRAM	CH10759	LTH	N/A
GONHER	N/A	MANN	HU7008Z
INTERFIL	OF3L62	SKY	N/A

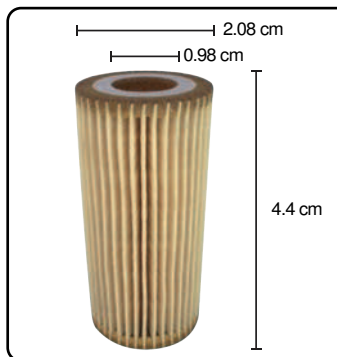

JE11784			
CARTUCHO			
BEETLE, GOLF, G T I , JETTA PASSAT 1.8. Y 2.0 LTS. 4 CIL. 13 - 17			
FRAM	CH11784	LTH	N/A
GONHER	N/A	MANN	N/A
INTERFIL	N/A	SKY	N/A



57187XP			
CARTUCHO SINTETICO			
BORA , JETTA A 4 ,BEETLE, GOLF ,1.9 4 CIL. CABRIOLET, DIESEL TURBO 1.9 4 CIL. 06 - 08			
FRAM	XG9911	LTH	N/A
GONHER	N/A	MANN	N/A
INTERFIL	N/A	SKY	N/A

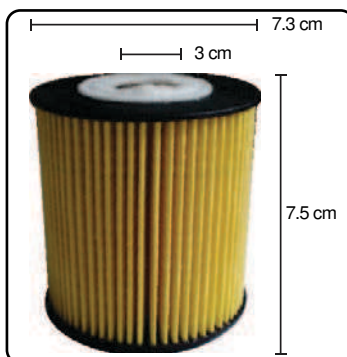

JE8712			
CARTUCHO			
VOLVO S 40 , S 60 , S 80 , V 40 Y V 70 , CROSS COUNTRY 2.3, 2.4 LTS. 20 VALV			
FRAM	CH8712	LTH	N/A
GONHER	G72	MANN	HU819X
INTERFIL	OF8712	SKY	N/A



JE9954			
CARTUCHO			
VOLVO C 30 , C 70 , S 40 , S 60 Y V 50 2.4 Y 2.5 LTS. 5 CIL. 06 - 12			
FRAM	CH9954	LTH	N/A
GONHER	G570F	MANN	HU719/8X
INTERFIL	OF9954	SKY	N/A

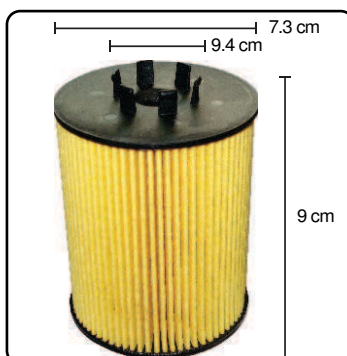

JE9955			
CARTUCHO			
BMW SERIES 500 , 600 Y 700 4.4 LTS. V 8 02 - 06 CAMIONETA X 5 4.4 Y 4.8 LTS.			
FRAM	CH9955	LTH	N/A
GONHER	N/A	MANN	N/A
INTERFIL	N/A	SKY	N/A



57021XP			
CARTUCHO SINTETICO			
VOLVO S40, S60, S80, V 40, V 70, CROSS COUNTRY 2.3, 2.4, LTS. 20 VAL. 01 - 07			
FRAM	XG8712	LTH	N/A
GONHER	N/A	MANN	HU 819/X
INTERFIL	OF8712	SKY	N/A



57186XP			
CARTUCHO SINTETICO			
C 30 , C 70 , S 40 , S 60 , V 50 2.4 2.5 LTS. 5 CIL. 06 12			
FRAM	XG9954	LTH	N/A
GONHER	N/A	MANN	N/A
INTERFIL	OF9954	SKY	N/A