

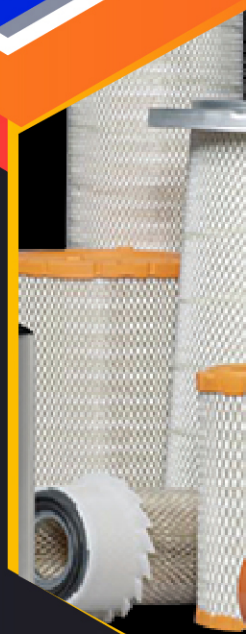

EURO QUALITY

CATALOGO FILTROS AIRE PARA SERVICIO PESADO 2021



VISUALIZACIÓN DESDE UNA
COMPUTADORA

PRESIONE CTRL + F

Para buscar la información de su filtro ya sea marca,
modelo o referencia cruzada.

WWW.FILTROSJOE.COM

SERVICIO A CLIENTES
33 38744001



VENTAS EN LÍNEA
33332 78986



INDICE

03	AA1167
	AA1175
	AA1191
	AA1193
	AA1194
	AA1195
04	AA1202
	AA1203
	AA1206
	AA1208
	AA1211
	AA1212
05	AA1213
	AA1219
	AA1220
	AA1221
	AA1225
	AA1229
06	AA1230
	AA1237
	AA1239
	AA1261
	AA1262
	AA1263
07	AA1264
	AA1268
	AA1270
	AA1282
	AA1284
	AA1288
08	AA1289
	AA1293
	AA1294
	AA1295
	AA1296
	AA1298
09	AA1299P
	AA1300
	AA1301
	AA1305
	AA1327
	AA1334
10	AA1335
	AA1357
	AA1358
	AA1367
	AA1368
	AA1370
11	AA1438
	AA1439
	AA1456
	AA1457
	AA1458
	AA1489
12	AA1513
	AA1513SY
	AA1558
	AA1559
	JE101
	JE102
13	JE103
	JE105
	JE8871
	JE9558



AA1167	PRIMARIO				
APLICACIÓN		EQUIVALENCIAS			
CAMIONES PARA PASAJEROS BOXER MERCEDES BENZ CON HOUSING REYTOR MOTOR OM-904 12 TON. MBO 18/60 14 TON. OMC-1418/51 14 TON.		FRAM	CF-9612	BALDWIN	RS-4586
		GONHER	GA-904R	LUBERFINER	LAF-3860
		DONALSON	P536036	REYTOR	IT-2000
		FLEETGUARD	AF-25856	WIX	MA-1510



AA1175	SECUNDARIO				
APLICACIÓN		EQUIVALENCIAS			
CAMIONES PARA PASAJEROS BOXER MERCEDES BENZ CON HOUSING REYTOR MOTOR OM-904 MBO-1018/52 12 TON. MBO 18/60 14 TON. OMC-1418/51 14 TON.		FRAM	CF-9313	BALDWIN	RS-4587
		GONHER	GA-905R	LUBERFINER	LAF-3861
		DONALSON	P616082	REYTOR	IT-2000 SY
		FLEETGUARD	AF-25857	WIX	MA-1511



AA1191	PRIMARIO				
APLICACIÓN		EQUIVALENCIAS			
CHEVROLET CAMIONES KODIAK (DIESEL) CON MOTOR CATERPIL-LAR 3116 SERIE 6000 - 7000 Y PARA CAMIONES FORD CON MOTOR CUMMINS DE 1900 C.C. MODELO 1995 - 1998		FRAM	CA-7139	BALDWIN	RS-2863
		GONHER	GA-197R	LUBERFINER	LAF-1878
		DONALSON	P527484	REYTOR	IT-2046
		FLEETGUARD	AF-4878	WIX	46433

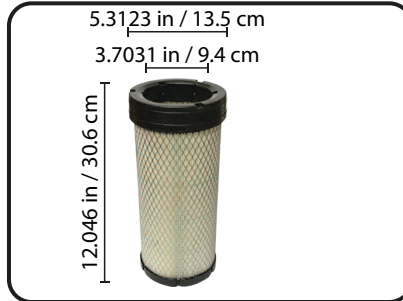

AA1193	SECUNDARIO				
APLICACIÓN		EQUIVALENCIAS			
CHEVROLET CAMIONES KODIAK (DIESEL) CON MOTOR CATERPIL-LAR 3116 SERIE 6000 - 7000 Y PARA CAMIONES FORD CON MOTOR CUMMINS DE 1900 C.C. MODELO 1995 - 1998		FRAM	CA-7139SY	BALDWIN	RS-3501
		GONHER	GA768R	LUBERFINER	LAF-3585
		DONALSON	P527680	REYTOR	IT-2046SY
		FLEETGUARD	AF-25215	WIX	46429

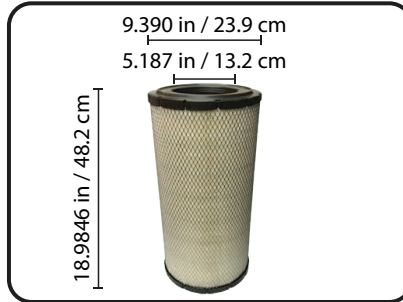

AA1194	PRIMARIO				
APLICACIÓN		EQUIVALENCIAS			
TRACTOCAMIONES FREIGHTLIN-ER FL 70 CUMMINS Y DETROIT DIESEL SERIE 50		FRAM	CA-8193	BALDWIN	RS-3517
		GONHER	GA-966R	LUBERFINER	LAF-4498
		DONALSON	P532966	REYTOR	IT-2066
		FLEETGUARD	AF-25667	WIX	46744



AA1195	PRIMARIO				
APLICACIÓN		EQUIVALENCIAS			
CAMIONES PARA PASAJEROS FORD WHITE G.M.C. DETROIT DIESEL 374.7 SERIE 60 Y VOLVO CON MOTOR CUMMINS NTC-315 1990 - 2012 IT906 6 CIL.		FRAM	CA-7140	BALDWIN	RS-3518
		GONHER	GA-682R	LUBERFINER	LAF-1849
		DONALSON	P527682	REYTOR	IT-2086
		FLEETGUARD	AF-25139M	WIX	46556



AA1202	SECUNDARIO				
APLICACIÓN		EQUIVALENCIAS			
TRACTOCAMIONES FREIGHTLINER FL 70 CUMMINS Y DETROIT DIESEL SERIE 50		FRAM	CA-8193SY	BALDWIN	RS-3717
		GONHER	GA-967R	LUBERFINER	LAF-3781
		DONALSON	P538542	REYTOR	IT-2066-S
		FLEETGUARD	AF-26114	WIX	46782



AA1203	PRIMARIO				
APLICACIÓN		EQUIVALENCIAS			
INTERNATIONAL CAMIONES Y AUTOBUSES NAVISTAR SERIES 9200 - 9300 DINA 9400, TRACTOR JOHN DEERE, HARVESTER		FRAM	CA-7466	BALDWIN	R-3530
		GONHER	GA-221R	LUBERFINER	LAF-1953
		DONALSON	P533235	REYTOR	IT2096
		FLEETGUARD	AF-25033	WIX	46745



AA1206	PRIMARIO				
APLICACIÓN		EQUIVALENCIAS			
DINA CON MOTOR NAVISTAR, TRACTORES JOHN DEERE SERIE 8100,8200 Y 8400 NAVISTAR CAMIONES Y AUTOBUSES INTERNATIONAL CAMIONES G.M. KODIACS, ISUZU FSR, FTV, FVR. STERLING, CATERPILLAR		FRAM	CA-8466	BALDWIN	RS-3548
		GONHER	GA-930R	LUBERFINER	LAF-3930
		DONALSON	P533930	REYTOR	IT-2076
		FLEETGUARD	AF-25354	WIX	46664



AA1208	SECUNDARIO				
APLICACIÓN		EQUIVALENCIAS			
DINA CON MOTOR NAVISTAR, TRACTORES JOHN DEERE SERIE 8100,8200 Y 8400 NAVISTAR CAMIONES Y AUTOBUSES INTERNATIONAL CAMIONES G.M. KODIACS, ISUZU FSR, FTV, FVR. STERLING, CATERPILLAR.		FRAM	CA-8229	BALDWIN	RS-3722
		GONHER	GA-890R	LUBERFINER	LAF-3890
		DONALSON	P533890	REYTOR	IT-2076-S
		FLEETGUARD	AF-25429	WIX	46665



AA1211	PRIMARIO				
APLICACIÓN		EQUIVALENCIAS			
GRUAS CASE, CATERPILLAR, JOHN DEERE Y NEW HOLLAND CAMION INTERNATIONAL, VOLVO, FERGUSON		FRAM	CA-8737	BALDWIN	RS-3544
		GONHER	GA-853R	LUBERFINER	LAF-4544
		DONALSON	P828889	REYTOR	IT-2006
		FLEETGUARD	AF-25352	WIX	46562



AA1212	PRIMARIO				
APLICACIÓN		EQUIVALENCIAS			
CAMIONES PARA PASAJEROS MERCEDES BENZ CON HOUSING REYTOR Y MOTOR OM-906, UNIDADES MARCO POLO "TORINO, ANDARE Y ALEGRO"		FRAM	CF-9614	BALDWIN	RS-4588
		GONHER	GA-906R	LUBERFINER	LAF-3864
		DONALSON	N/D	REYTOR	IT-2056
		FLEETGUARD	AF-26291	WIX	46573



AA1213	SECUNDARIO				
APLICACIÓN		EQUIVALENCIAS			
CAMIONES PARA PASAJEROS MERCEDES BENZ CON HOUSING REYTOR Y MOTOR OM-906, UNIDADES MARCO POLO "TORINO, ANDARE Y ALEGRO"		FRAM	CF-9615	BALDWIN	RS-4589
		GONHER	GA-907R	LUBERFINER	LAF-3865
		DONALSON	N/D	REYTOR	IT-2056-S
		FLEETGUARD	N/D	WIX	N/D



AA1219	PRIMARIO				
APLICACIÓN		EQUIVALENCIAS			
CAMIONES PARA PASAJEROS MERCEDES BENZ CON HOUSING REYTOR VOLVO C11-R CAMION CUMMINS, C11-R URBANUS		FRAM	CA-9721	BALDWIN	N/D
		GONHER	GA-909R	LUBERFINER	LAF-3862
		DONALSON	N/D	REYTOR	IT-2015
		FLEETGUARD	AF-26111M	WIX	N/D



AA1220	SECUNDARIO				
APLICACIÓN		EQUIVALENCIAS			
CAMIONES PARA PASAJEROS MERCEDES BENZ CON HOUSING REYTOR		FRAM	CA-9721SY	BALDWIN	N/D
		GONHER	GA-908R	LUBERFINER	LAF-3863
		DONALSON	N/D	REYTOR	IT-2015-S
		FLEETGUARD	AF-26105	WIX	N/D



AA1221	PRIMARIO				
APLICACIÓN		EQUIVALENCIAS			
CAMIONES VOLVO SERIE VN CON MOTOR CUMMINS Y MOTOR DETROIT DIESEL SERIE 60		FRAM	CA-8598	BALDWIN	RS-3740
		GONHER	GA-435R	LUBERFINER	LAF-5722
		DONALSON	P540388	REYTOR	IT-2098
		FLEETGUARD	AF-25435	WIX	46772



AA1225	SECUNDARIO				
APLICACIÓN		EQUIVALENCIAS			
CAMIONES FORD WHITE G.M.C. DETROIT DIESEL 374,7 SERIE 60 Y VOLVO CON MOTOR CUMMINS NTC-315 1990 - 1998		FRAM	CA-7140SY	BALDWIN	RS-3519
		GONHER	GA-683R	LUBERFINER	LAF-1956
		DONALSON	P527683	REYTOR	IT-2086-S
		FLEETGUARD	AF-25345	WIX	46628



AA1229	PRIMARIO				
APLICACIÓN		EQUIVALENCIAS			
CAMIONES INTERNATIONAL 2003 SERIE 4400 I.H.C. HARVESTER CAMION 4100, 4200, 4300, 4400 WORKSTAR, TRANSTAR		FRAM	CA-9346	BALDWIN	RS-4636
		GONHER	GA-799R	LUBERFINER	LAF-9099
		DONALSON	P606503	REYTOR	N/D
		FLEETGUARD	AF-25707	WIX	46870

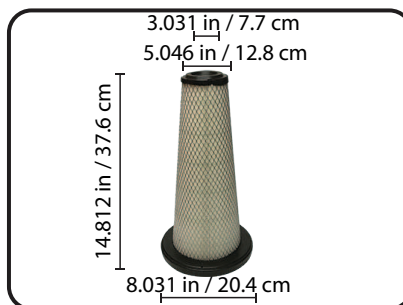

AA1230	SECUNDARIO				
APLICACIÓN		EQUIVALENCIAS			
CAMIONES INTERNATIONAL 2003 SERIE 4400 I.H.C. HARVESTER CAMION 4100, 4200, 4300, 4400 WORKSTAR, TRANSTAR		FRAM	CA-9346SY	BALDWIN	RS-4637
		GONHER	GA-798R	LUBERFINER	LAF-9102
		DONALSON	P609239	REYTOR	N/D
		FLEETGUARD	AF-25732	WIX	46871



AA1237	SECUNDARIO				
APLICACIÓN		EQUIVALENCIAS			
GRUAS CASE, CATERPILLAR, JOHN DEERE, INTERNATIONAL, VOLVO Y NEW HOLLAND		FRAM	CA-8737SY	BALDWIN	RS-4545
		GONHER	GA-854R	LUBERFINER	LAF-4545
		DONALSON	P829333	REYTOR	N/D
		FLEETGUARD	AF-25558	WIX	46469

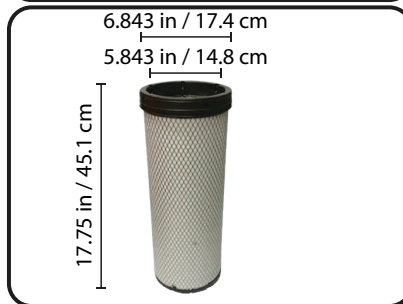

AA1239	SECUNDARIO				
APLICACIÓN		EQUIVALENCIAS			
INTERNATIONAL CAMIONES Y AUTOBUSES NAVISTAR SERIES 9200 - 9300 HARVESTER CAMION JOHN DEERE, TRACTOR		FRAM	CA-8511SY	BALDWIN	RS-3531
		GONHER	GA-723R	LUBERFINER	LAF-5720
		DONALSON	P533723	REYTOR	IT-2096-S
		FLEETGUARD	AF-25430	WIX	46983

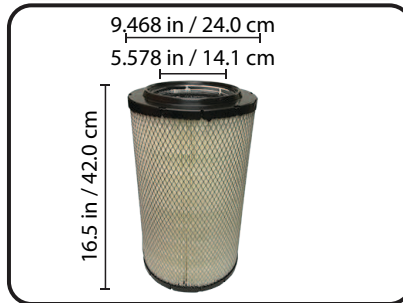

AA1261	PRIMARIO				
APLICACIÓN		EQUIVALENCIAS			
CAMIONES Y AUTOBUSES MERCEDES BENZ AÑO 2004 CON HOUSING REYTOR		FRAM	CA-9639	BALDWIN	RS-5348
		GONHER	GA-801R	LUBERFINER	LAF-5763
		DONALSON	P603232	REYTOR	IT-2004
		FLEETGUARD	AF-26287M	WIX	MA-1500

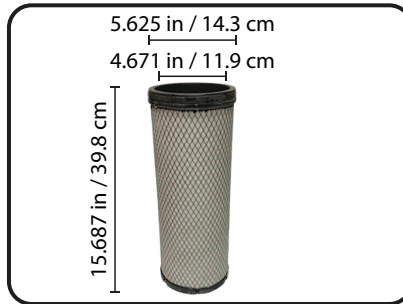

AA1262	SECUNDARIO				
APLICACIÓN		EQUIVALENCIAS			
CAMIONES Y AUTOBUSES MERCEDES BENZ AÑO 2004 CON HOUSING REYTOR		FRAM	CA-9639SY	BALDWIN	RS-5347
		GONHER	GA-802R	LUBERFINER	LAF-5764
		DONALSON	P603233	REYTOR	IT-2004-S
		FLEETGUARD	AF-26288	WIX	MA-1501

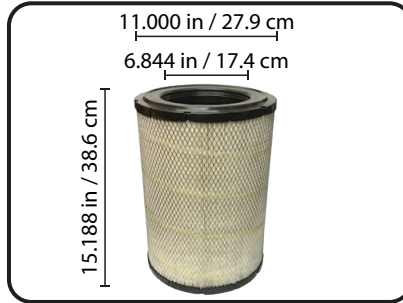

AA1263	PRIMARIO				
APLICACIÓN		EQUIVALENCIAS			
TRACTOCAMIONES KENWORTH T-2000 CON MOTOR CATERPILLAR CUMMINS		FRAM	CA-9009	BALDWIN	RS-3750
		GONHER	GA-968R	LUBERFINER	LAF-5873
		DONALSON	P542101	REYTOR	N/D
		FLEETGUARD	AF-25598	WIX	42455



AA1264	PRIMARIO				
APLICACIÓN		EQUIVALENCIAS			
CAMIONES INTERNATIONAL, NAVISTAR TRANSTAR CON MOTOR HT570, CATERPILLAR C11, C13, NAVISTAR MAXX FORSE		FRAM	CA-10305	BALDWIN	RS-4862
		GONHER	GA-4862R	LUBERFINER	LAF-6663
		DONALSON	P613336	REYTOR	N/A
		FLEETGUARD	AF-26103	WIX	49088



AA1268	PRIMARIO				
APLICACIÓN		EQUIVALENCIAS			
TRACTOCAMION VOLVO VHD, VED12 2004 CON MOTOR CUMMINS		FRAM	CA-9901	BALDWIN	RS-4642
		GONHER	GA-624R	LUBERFINER	LAF-9201
		DONALSON	P605551	REYTOR	N/D
		FLEETGUARD	AF-26163M	WIX	49126



AA1270	PRIMARIO				
APLICACIÓN		EQUIVALENCIAS			
CAMIONES CUMMINS CASE I.H 580 4BT MOTOR 3.9 PRIMARIO		FRAM	CA-9874	BALDWIN	RS-3708
		GONHER	N/D	LUBERFINER	LAF-8124
		DONALSON	P536940	REYTOR	N/D
		FLEETGUARD	AF-25524	WIX	46662



AA1282	PRIMARIO				
APLICACIÓN		EQUIVALENCIAS			
AUTOBUSES SCANIA, IRIZAR N94 LEYLAND FT95 CAMION SOLARIS URBINO, IRISBUR 370 SCANIA P113		FRAM	CA-4893	BALDWIN	PA-2815
		GONHER	N/D	LUBERFINER	LAF-1750
		DONALSON	P771575	REYTOR	N/D
		FLEETGUARD	AF-25045M	WIX	N/D

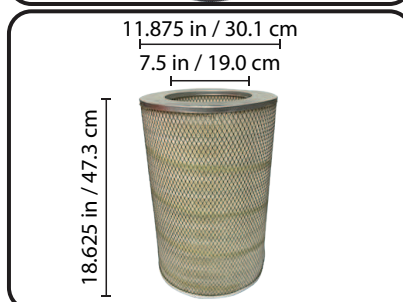

AA1284	INDIVIDUAL				
APLICACIÓN		EQUIVALENCIAS			
AUTOBUSES VOLVO Y MERCEDES BENZ, MAN CAMION PEGASSO		FRAM	CA-4215	BALDWIN	PA-2776
		GONHER	GA-467	LUBERFINER	LAF-1726
		DONALSON	P771558	REYTOR	IT-3002
		FLEETGUARD	AF-1802	WIX	46741



AA1288	INDIVIDUAL				
APLICACIÓN		EQUIVALENCIAS			
CAMIONES FORD A GASOLINA V-8 - 370 Y 429 CAMION FORD F-250 Y F-350 SUPER DUTY V-8 444 7.3 LTS TURBO DIESEL		FRAM	CA-3686	BALDWIN	PA-2116
		GONHER	GA-422	LUBERFINER	LAF-588
		DONALSON	P181188	REYTOR	N/D
		FLEETGUARD	AF-1878	WIX	46204

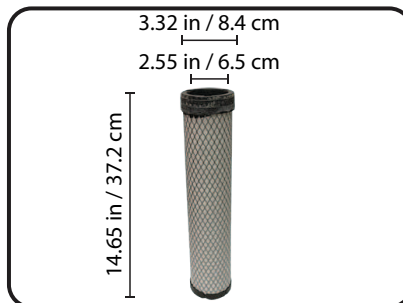

AA1289	SECUNDARIO				
APLICACIÓN		EQUIVALENCIAS			
CAMIONES CUMMINS CASE I.H 580 4BT MOTOR 3.9		FRAM	CA-9874SY	BALDWIN	RS-3709
		GONHER	N/D	LUBERFINER	LAF-8405
		DONALSON	P536941/71	REYTOR	N/D
		FLEETGUARD	AF-25521	WIX	46663

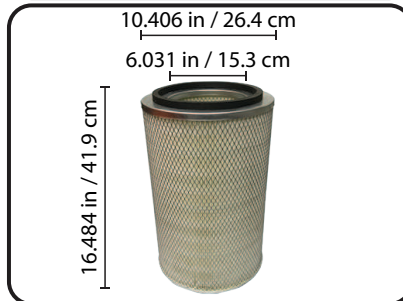

AA1293	PRIMARIO				
APLICACIÓN		EQUIVALENCIAS			
CAMIONES MERCEDES BENZ LPS 1525 TAPAS METALICAS		FRAM	CA-1596	BALDWIN	PA-2521
		GONHER	GA-209	LUBERFINER	LAF-9545
		DONALSON	P181028	REYTOR	IT-1596
		FLEETGUARD	AF-979	WIX	42253



AA1294	SECUNDARIO				
APLICACIÓN		EQUIVALENCIAS			
CAMIONES MERCEDES BENZ LPS 1525 TAPAS METALICAS		FRAM	CA-1596SY	BALDWIN	PA-2522
		GONHER	GA-210	LUBERFINER	LAF-7640
		DONALSON	P137640	REYTOR	IT-1596-S
		FLEETGUARD	AF-987	WIX	42254



AA1295	INDIVIDUAL				
APLICACIÓN		EQUIVALENCIAS			
VOLVO BUS 7550 MOTOR VED12		FRAM	CA5189	BALDWIN	N/A
		GONHER	N/A	LUBERFINER	N/A
		DONALSON	P778605	REYTOR	N/A
		FLEETGUARD	AF4560	WIX	42875



AA1296	SECUNDARIO				
APLICACIÓN		EQUIVALENCIAS			
CAMIONES VOLVO Y MINIBUSES		FRAM	CA-5189SY	BALDWIN	PA-2775
		GONHER	N/D	LUBERFINER	LAF-5832
		DONALSON	P500231	REYTOR	N/D
		FLEETGUARD	AF-4746	WIX	N/D

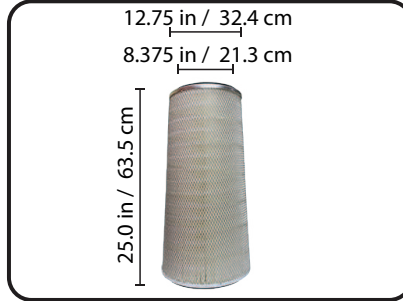

AA1298	INDIVIDUAL				
APLICACIÓN		EQUIVALENCIAS			
CAMION DINA CON MOTOR PERKINS 354 Y PERKINS 354 FASE 4		FRAM	CA-6326	BALDWIN	PA-2631
		GONHER	GA-371	LUBERFINER	LAF-2100
		DONALSON	P142100	REYTOR	IT-2100
		FLEETGUARD	AF-1817M	WIX	46860



AA1299 P	INDIVIDUAL		
APLICACIÓN	EQUIVALENCIAS		
CAMION CON MOTOR CUMMINS Y CATERPILLAR, KENWORTH, FRETHER TAPA INFERIOR DE POLIURETANO	FRAM	CA-3990	BALDWIN PA-2705
	GONHER	GA-3551	LUBERFINER LAF-3551
	DONALSON	P153551	REYTOR N/D
	FLEETGUARD	AF-1968M	WIX 46883



AA1300	PRIMARIO		
APLICACIÓN	EQUIVALENCIAS		
CAMION MERCEDES Y VOLKSWAGEN CONSTELLATION CON HOUSING FRAM CAMION WORKER 24-250E	FRAM	CA-5626PU	BALDWIN RS-5627
	GONHER	GA-8864R	LUBERFINER LAF-3864
	DONALSON	P618941	REYTOR IT-3050
	FLEETGUARD	AF-25997	WIX WA-1512



AA1301	SECUNDARIO		
APLICACIÓN	EQUIVALENCIAS		
CAMION MERCEDES Y VOLKSWAGEN CONSTELLATION CON HOUSING FRAM CAMION WORKER 24-250E	FRAM	CA-5626SY	BALDWIN RS-5628
	GONHER	N/D	LUBERFINER N/D
	DONALSON	P621918	REYTOR IT-3050S
	FLEETGUARD	AF-26211	WIX WA-1513

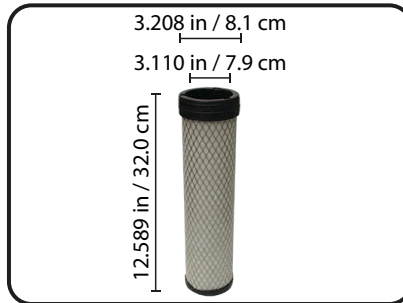

AA1305	SECUNDARIO		
APLICACIÓN	EQUIVALENCIAS		
CARGADORAS CATERPILLAR 216B, 226B, 232B, 242B TRACTOR JOHN DEERE 4120, BOB CAT 863 863H 341 D 883	FRAM	CA-9269SY	BALDWIN RS-3543
	GONHER	N/D	LUBERFINER LAF-9332
	DONALSON	P829332	REYTOR N/D
	FLEETGUARD	AF-25484	WIX 46672



AA1327	PRIMARIO		
APLICACIÓN	EQUIVALENCIAS		
FILTRO PARA AIRE MONTACAR-GAS	FRAM	CA-10410	BALDWIN RS-3940
	GONHER	N/D	LUBERFINER LAF-8687
	DONALSON	P610903	REYTOR N/D
	FLEETGUARD	AF-25337M	WIX 42806



AA1334	PRIMARIO		
APLICACIÓN	EQUIVALENCIAS		
MIDIBUS MERCEDES BENZ OM904LA CON HAUSIN REYTOR	FRAM	CA-10389	BALDWIN RS-5452
	GONHER	GA-3095R	LUBERFINER N/D
	DONALSON	P616091	REYTOR IT-3095
	FLEETGUARD	AF-26358	WIX MA-1502

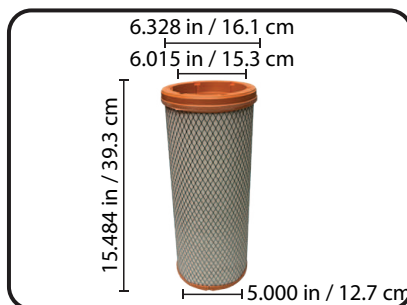

AA1335	SECUNDARIO				
APLICACIÓN		EQUIVALENCIAS			
MIDIBUS MERCEDES BENZ OM904LA CON HAUSIN REYTOR		FRAM	CA-10389SY	BALDWIN	RS-5453
		GONHER	GA-3096R	LUBERFINER	N/D
		DONALSON	P616097	REYTOR	IT3095SY
		FLEETGUARD	AF-26290	WIX	MA-1503

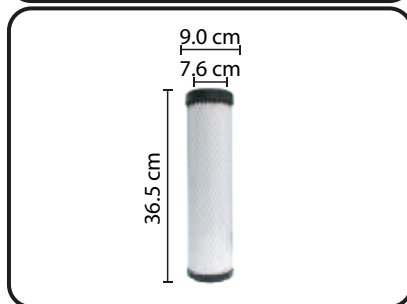

AA1357	SECUNDARIO				
APLICACIÓN		EQUIVALENCIAS			
CAMION MERCEDES BENZ ACCELO 1016 OM 924 BOXER 904		FRAM	N/D	BALDWIN	N/D
		GONHER	N/D	LUBERFINER	N/D
		DONALSON	P621911	REYTOR	N/D
		FLEETGUARD	N/D	WIX	N/D



AA1358	PRIMARIO				
APLICACIÓN		EQUIVALENCIAS			
CAMION MERCEDES BENZ ACCELO 1016 OM 924 BOXER 904		FRAM	N/D	BALDWIN	N/D
		GONHER	N/D	LUBERFINER	N/D
		DONALSON	P619053	REYTOR	N/D
		FLEETGUARD	N/D	WIX	N/D

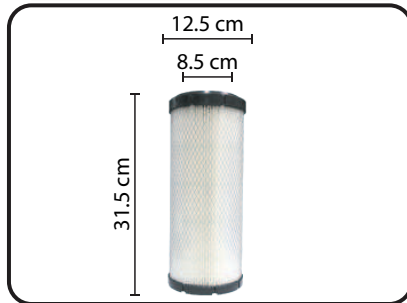

AA1367	PRIMARIO				
APLICACIÓN		EQUIVALENCIAS			
MONTACARGAS BOBCAT, CATERPILLAR Y HITACHI. EXCAVADORA VOLVO, KOMATSU		FRAM	CA-9246	BALDWIN	RS3549
		GONHER	N/D	LUBERFINER	LAF-8143
		DONALSON	P822768	REYTOR	N/D
		FLEETGUARD	AF-25308	WIX	46489

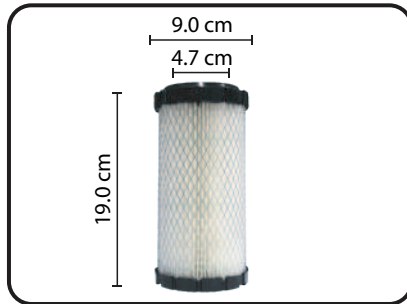

AA1368	PRIMARIO				
APLICACIÓN		EQUIVALENCIAS			
MONTACARGAS BOBCAT, CASE Y CATERPILLAR, EXCAVADORA VOLVO, JOHN DEERE CON MOTOR KAWASAKI		FRAM	CA-9248	BALDWIN	RS-3715
		GONHER	N/D	LUBERFINER	LAF-8388
		DONALSON	P822686	REYTOR	N/D
		FLEETGUARD	AF-2550	WIX	46449



AA1370	INDIVIDUAL				
APLICACIÓN		EQUIVALENCIAS			
VOLKSWAGEN CAMION WORKER 8-150 CUMMINS INTERACT 3.9L (4 CIL.)		FRAM	CA-283S	BALDWIN	N/D
		GONHER	GA-8150	LUBERFINER	LAF-8881
		DONALSON	P619859	REYTOR	IT-3005
		FLEETGUARD	AF-25075	WIX	MA-1509



AA1438	PRIMARIO				
APLICACIÓN		EQUIVALENCIAS			
MIDIBUS MERCEDES BENZ OM 904 Y OM 906 MODELOS 2010 Y 2011		FRAM	N/D	BALDWIN	N/D
		GONHER	N/D	LUBERFINER	N/D
		DONALSON	P623166	REYTOR	IT-3098
		FLEETGUARD	N/D	WIX	WA-1523



AA1439	SECUNDARIO				
APLICACIÓN		EQUIVALENCIAS			
MIDIBUS MERCEDES BENZ OM 904 Y OM 906 MODELOS 2010 Y 2011		FRAM	N/D	BALDWIN	N/D
		GONHER	N/D	LUBERFINER	N/D
		DONALSON	P623172	REYTOR	IT-3098S
		FLEETGUARD	N/D	WIX	WA-1524

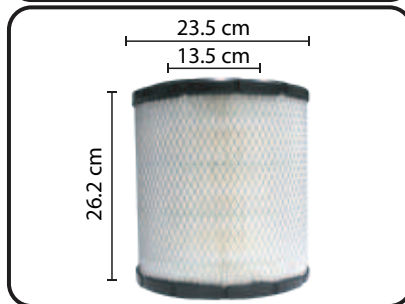

AA1456	INDIVIDUAL				
APLICACIÓN		EQUIVALENCIAS			
TOYOTA HINO 300		FRAM	N/D	BALDWIN	N/D
		GONHER	N/D	LUBERFINER	N/D
		DONALSON	N/D	REYTOR	N/D
		FLEETGUARD	N/D	WIX	N/D



AA1457	PRIMARIO				
APLICACIÓN		EQUIVALENCIAS			
MERCEDES BENZ OF-924 MOTOR DELANTERO 2012 - 2015 (CHATO)		FRAM	N/D	BALDWIN	N/D
		GONHER	N/D	LUBERFINER	LAF-7417
		DONALSON	P619046	REYTOR	IT-3101
		FLEETGUARD	AF-323	WIX	N/D



AA1458	SECUNDARIO				
APLICACIÓN		EQUIVALENCIAS			
MERCEDES BENZ OF-924 MOTOR DELANTERO 2012 - 2015 (CHATO)		FRAM	N/D	BALDWIN	N/D
		GONHER	N/D	LUBERFINER	LAF-7418
		DONALSON	N/D	REYTOR	IT-3101S
		FLEETGUARD	N/D	WIX	N/D

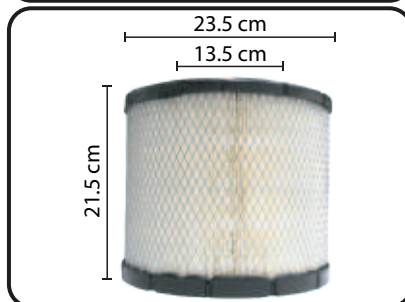

AA1489	INDIVIDUAL				
APLICACIÓN		EQUIVALENCIAS			
TOYOTA HINO		FRAM	N/D	BALDWIN	N/D
		GONHER	N/D	LUBERFINER	N/D
		DONALSON	N/D	REYTOR	N/D
		FLEETGUARD	N/D	WIX	N/D

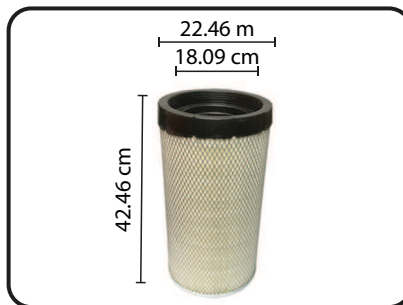

AA1513	PRIMARIO				
APLICACIÓN		EQUIVALENCIAS			
CAMIONES DINA		FRAM	CA-10981	BALDWIN	RS-4992
		GONHER	GA-770R	LUBERFINER	LAF-6922
		DONALSON	P613334	REYTOR	N/D
		FLEETGUARD	AF-25963	WIX	46922

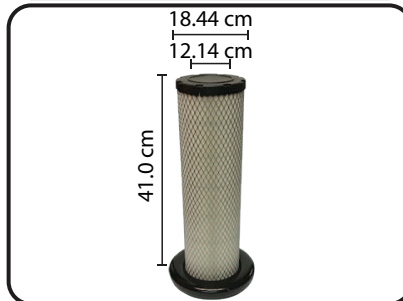

AA1513SY	SECUNDARIO				
APLICACIÓN		EQUIVALENCIAS			
CAMIONES DINA		FRAM	CA-10981SY	BALDWIN	RS-5329
		GONHER	N/D	LUBERFINER	LAF-6923
		DONALSON	P613335	REYTOR	N/D
		FLEETGUARD	AF-25963	WIX	46923



AA1558	PRIMARIO				
APLICACIÓN		EQUIVALENCIAS			
FILTRO PARA AIRE CAMION URBANO MERCEDES BENZ 2016-2018		FRAM	N/D	BALDWIN	N/D
		GONHER	N/D	LUBERFINER	N/D
		DONALSON	N/D	REYTOR	IT-3170
		FLEETGUARD	N/D	WIX	N/D

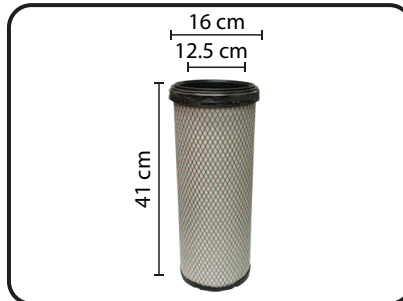

AA1559	SECUNDARIO				
APLICACIÓN		EQUIVALENCIAS			
FILTRO PARA AIRE CAMION URBANO MERCEDES BENZ 2016-2018		FRAM	N/D	BALDWIN	N/D
		GONHER	N/D	LUBERFINER	N/D
		DONALSON	N/D	REYTOR	IT-3170S
		FLEETGUARD	N/D	WIX	N/D



JE101	CARTUCHO				
APLICACIÓN		EQUIVALENCIAS			
FILTRO ACEITE ECOLOGICO MERCEDES BENZ OM-906		FRAM	CH-9260	BALDWIN	P7188
		GONHER	G-3754	LUBERFINER	LP-8741
		DONALSON	P-550761	REYTOR	N/D
		FLEETGUARD	LF-3914	WIX	57215



JE102	CARTUCHO				
APLICACIÓN		EQUIVALENCIAS			
FILTRO ACEITE ECOLOGICO MERCEDES BENZ OM-904 MOD. 2003-2017		FRAM	CH-5957	BALDWIN	P-7199
		GONHER	G-3827	LUBERFINER	LP-8700
		DONALSON	P-550768	REYTOR	N/D
		FLEETGUARD	LF-3827	WIX	57214



JE103		CARTUCHO			
APLICACIÓN		EQUIVALENCIAS			
FILTRO COMBUSTIBLE MERCEDES BENZ OM-904-906 MOD. 2003-2017 BOXER, MIDIBUS FREIGHTLINER.		FRAM	C-9261	BALDWIN	P-7735
		GONHER	G-1046	LUBERFINER	L-8701F
		DONALSON	P-550632	REYTOR	N/D
		FLEETGUARD	LF-5380	WIX	33634

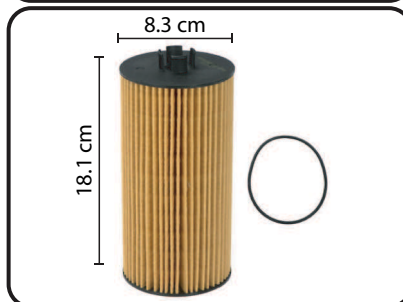

JE105		CARTUCHO			
APLICACIÓN		EQUIVALENCIAS			
FILTRO PARA ACEITE ECOLOGICO FORD FREIGLANDER SERIES F-150,250,350,450 Y 550 EXCURSION 6.0 TURBO DIESEL 2003 - 2014		FRAM	CH-9549	BALDWIN	N/D
		GONHER	G-3752	LUBERFINER	LP-2016
		DONALSON	P-550528	REYTOR	N/D
		FLEETGUARD	LF-16166	WIX	57314



JE8871		CARTUCHO			
APLICACIÓN		EQUIVALENCIAS			
FILTRO ACEITE CAMIONES V.W. BOCHOBUS		FRAM	CH-8871	BALDWIN	N/D
		GONHER	N/D	LUBERFINER	P-847
		DONALSON	N/D	REYTOR	N/D
		FLEETGUARD	LF-3769	WIX	51187

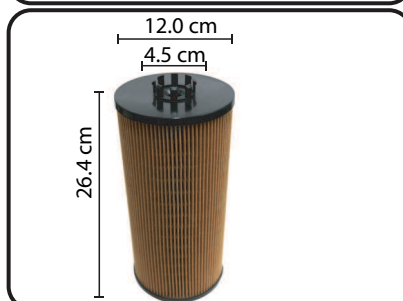

JE9558		CARTUCHO			
APLICACIÓN		EQUIVALENCIAS			
FILTRO ACEITE MERCEDES BENZ AXOR CAMION, ESTERLING WESTERN STAR, FREIGHTLINER CLASSIC CAMION COLUMBIA BUSINESS CLASS M2		FRAM	CH-9558	BALDWIN	BK-6676
		GONHER	G-2109	LUBERFINER	LP-5048
		DONALSON	P-550769	REYTOR	RL-16046
		FLEETGUARD	MK-13128 / MK13068	WIX	57213

PRECIOS A PARTIR MARZO 2019
ESTOS PRECIOS SON MAS IVA