

FILTROS Y  
AUTOPARTES

# CATALOGO FILTROS CABINA AUTOMOTRIZ 2023



CAPAS CON  
MICROFILTRACIÓN  
Y CARBÓN ACTIVADO



VISUALIZACIÓN DESDE UNA  
COMPUTADORA

**PRESIONE CTRL + F**

Para buscar la información de su filtro ya sea marca,  
modelo o referencia cruzada.

[WWW.FILTROSJOE.COM](http://WWW.FILTROSJOE.COM)

SERVICIO A CLIENTES  
33 38744001



VENTAS EN LÍNEA  
33332 78986



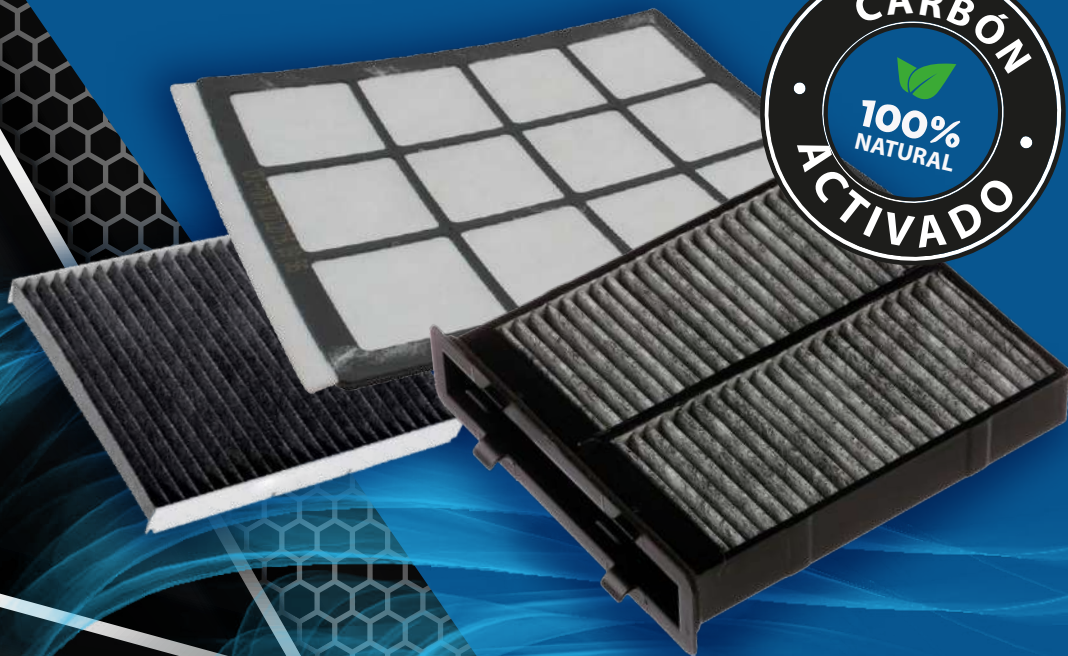

# FILTROS DE CABINA

## AUTOMOTRIZ

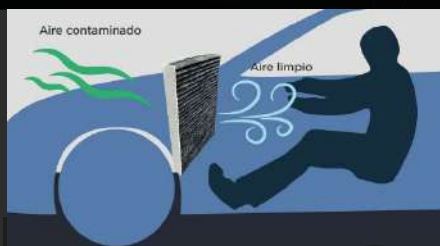

CAPAS CON  
MICROFILTRACIÓN  
Y CARBÓN ACTIVADO

### Principal Función

Diseñados para limpiar las impurezas contaminantes del ambiente al momento de encender el clima del vehículo; retienen las partículas contaminantes protegiendo la salud del pasajero y proveen de aire fresco al interior del vehículo.

### Un Nuevo Filtro Ayuda

- Eleva la seguridad en el manejo al evitar que se empañen los cristales del vehículo.
- Ayuda a evitar enfermedades como: asma, dolores de cabeza, fatiga, entre otros, a través de la retención de partículas contaminantes.
- Es importante para el buen funcionamiento del aire acondicionado. Ayuda a generar un ambiente más saludable para los usuarios del vehículo.

**FILTROS JOE®**  
recomienda  
**REEMPLAZAR EL FILTRO**

**NO contribuyas a  
enfermedades respiratorias.  
Evita impurezas, humedad y  
malos olores.**

### Importancia del cambio de filtro

- El aire queda libre de impurezas al interior del automóvil.
- Consumes menos gasolina, el fluido del aire sale directo y evita forzar al equipo de aire acondicionado.

### IMPORTANCIA DEL CARBÓN ACTIVADO EN EL FILTRO DE CABINA

**EL CARBÓN ACTIVADO EN EL FILTRO DE CABINA** deja a fuera contaminantes gaseosos tales como óxidos de nitrógeno, los vapores del combustible, ozono y otros olores del aire circundante.



# FILTROS CABINA

# AUTOMOTRIZ

## ÍNDICE

|               |    |
|---------------|----|
| ACURA         | 3  |
| AUDI          | 4  |
| BAIC          | 7  |
| BMW           | 7  |
| BUICK         | 9  |
| CADILLAC      | 10 |
| CHEVROLET     | 12 |
| CHRYSLER      | 19 |
| DODGE         | 22 |
| FIAT          | 26 |
| FORD          | 27 |
| FREIGHTLINER  | 33 |
| GMC           | 33 |
| HONDA         | 35 |
| HUMMER        | 37 |
| HYUNDAI       | 37 |
| INFINITI      | 41 |
| JAGUAR        | 42 |
| JEEP          | 42 |
| KIA           | 44 |
| LAND ROVER    | 46 |
| LEXUS         | 47 |
| LINCOLN       | 49 |
| MAZDA         | 50 |
| MERCEDES BENZ | 54 |
| MERCURY       | 56 |
| MINI COOPER   | 57 |
| MITSUBISHI    | 58 |
| NISSAN        | 59 |
| PEUGEOT       | 64 |
| PONTIAC       | 66 |
| PORSCHE       | 68 |
| RENAULT       | 69 |
| ROLL ROYCE    | 72 |
| SAAB          | 72 |
| SATURN        | 73 |
| SEAT          | 73 |
| SMART         | 75 |
| SUBARU        | 75 |
| SUZUKI        | 76 |
| TOYOTA        | 79 |
| VW            | 81 |
| VOLVO         | 85 |

Cuidamos de ti  
y de la vida útil de tu motor

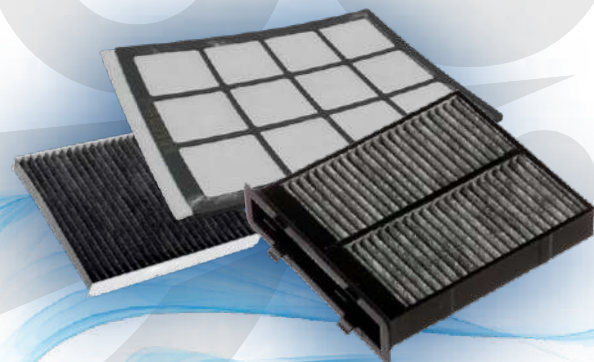

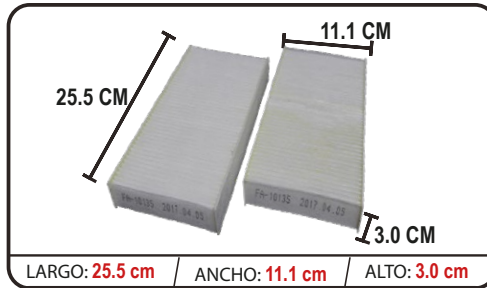

| ACURA   |  | JAC2S5A      |                 |
|---|--|--------------|-----------------|
| APLICACIÓN  |  | EQUIVALENCIA |                 |
| RSX 2002-2006 4C 2.0L / SPORT COUPE 2002-2006 4C 2.0L / |  | CF10135      | <b>FRAM</b>     |
|   |  | CFI-2S5A     | <b>INTERFIL</b> |
|   |  | 24817        | <b>WIX</b>      |

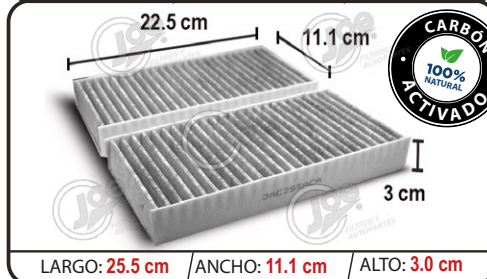

| ACURA   |  | JAC2S5ACA    |                 |
|---|--|--------------|-----------------|
| APLICACIÓN  |  | EQUIVALENCIA |                 |
| RSX 2002-2006 4C 2.0L / SPORT COUPE 2002-2006 4C 2.0L / |  | CF10135      | <b>FRAM</b>     |
|   |  | CFI-2S5ACA   | <b>INTERFIL</b> |
|   |  | 24817        | <b>WIX</b>      |

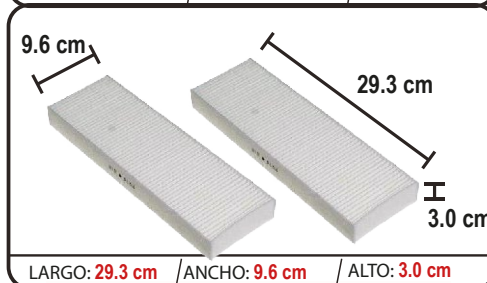

| ACURA                    |  | JAC8029      |                 |
|--------------------------|--|--------------|-----------------|
| APLICACIÓN               |  | EQUIVALENCIA |                 |
| CL 2001-2003 V6 3.2 LTS. |  | CF10134      | <b>FRAM</b>     |
|                          |  | CFI-8090     | <b>INTERFIL</b> |
|                          |  | 24752        | <b>WIX</b>      |

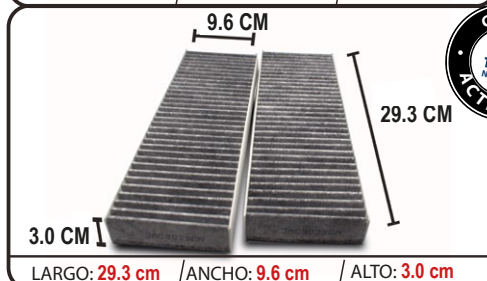

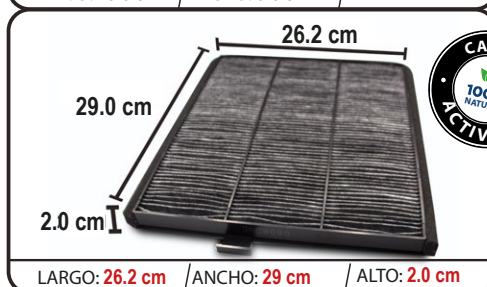

| ACURA                    |  | JAC8029CA    |                 |
|--------------------------|--|--------------|-----------------|
| APLICACIÓN               |  | EQUIVALENCIA |                 |
| CL 2001-2003 V6 3.2 LTS. |  | CF10134      | <b>FRAM</b>     |
|                          |  | CFI-8090CA   | <b>INTERFIL</b> |
|                          |  | 24752        | <b>WIX</b>      |

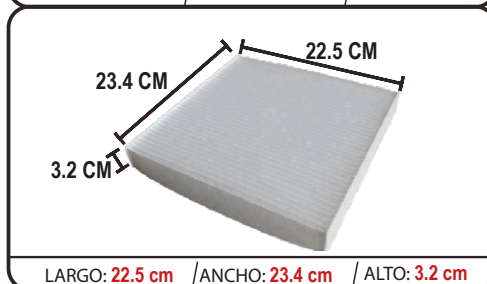

| ACURA                   |  | JAC8090CA    |                 |
|-------------------------|--|--------------|-----------------|
| APLICACIÓN              |  | EQUIVALENCIA |                 |
| MDX 2001-2006 6C 3.5L / |  | CF8813       | <b>FRAM</b>     |
|                         |  | CFI-8090     | <b>INTERFIL</b> |
|                         |  | 24897        | <b>WIX</b>      |

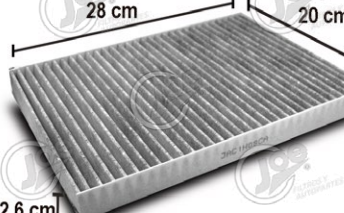

| ACURA   |  | JAC8092      |                 |
|---|--|--------------|-----------------|
| APLICACIÓN  |  | EQUIVALENCIA |                 |
| ILX 2013-2019 4C 2.0L / ILX 2013-2019 4C 2.4L / ILX HIBRIDO 2013-2014 4C 1.5L / MDX 2007-2013 4C 2.3L / MDX 2013-2019 6C 3.5L / RL 2005-2013 6C 3.5L / RLX 2014-2016 6C 3.5L / TL 2004-2008 6C 3.2L / TL 2007-2014 6C 3.5L / TL 2009-2014 6C 3.7L / TLX 2015-2019 4C 2.5L / TLX 2016-2019 6C 3.5L / TSX 2004-2014 4C 2.4L / TSX 2010-2014 6C 3.5L / ZDX 2010-2013 6C 3.7L / |  | CF10134      | <b>FRAM</b>     |
|   |  | CFI-8092     | <b>INTERFIL</b> |
|   |  | 24815        | <b>WIX</b>      |

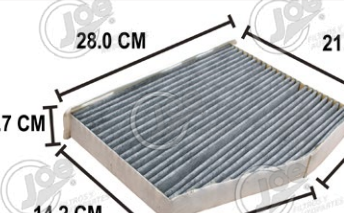
|   |  |  |         |      |            |          |        |     |
|---|--|--|---------|------|------------|----------|--------|-----|
|  <p>3.2 cm   22.5 cm   23.4 cm</p> <p>LARGO: 23.4 cm / ANCHO: 22.5 cm / ALTO: 3.2 cm</p>                             | <p><b>ACURA</b></p> <p>ILX 2013-2019 4C 2.0L / ILX 2013-2019 4C 2.4L / ILX HIBRIDO 2013-2014 4C 1.5L / MDX 2007-2013 4C 2.3L / MDX 2013-2019 6C 3.5L / RL 2005-2013 6C 3.5L / RLX 2014-2016 6C 3.5L / TL 2004-2008 6C 3.2L / TL 2007-2014 6C 3.5L / TL 2009-2014 6C 3.7L / TLX 2015-2019</p>   | <p><b>JAC8092CA</b></p> <p>EQUIVALENCIA</p> <table border="1"> <tr><td>CF10134</td><td>FRAM</td></tr> <tr><td>CFI-8092CA</td><td>INTERFIL</td></tr> <tr><td>24815</td><td>WIX</td></tr> </table> | CF10134 | FRAM | CFI-8092CA | INTERFIL | 24815  | WIX |
| CF10134   | FRAM   |  |         |      |            |          |        |     |
| CFI-8092CA  | INTERFIL   |  |         |      |            |          |        |     |
| 24815   | WIX  |  |         |      |            |          |        |     |
|  <p>28.0 cm   20.6 cm   2.7 cm</p> <p>LARGO: 28.0 cm / ANCHO: 20.6 cm / ALTO: 2.7 cm</p>                             | <p><b>AUDI</b></p> <p>A3 ATTRACTION 2003-2005 2003-2005 4C 1.8L / TT 2000-2006 4C 1.8L / TT COUPE 2000-2002 4C 1.8L / TT QUATTRO 2000-2006 4C 1.8L / TT QUATTRO 2001-4C 1.8L / TT QUATTRO 2004-2006 6C 3.2L /</p>  | <p><b>JAC1H08</b></p> <p>EQUIVALENCIA</p> <table border="1"> <tr><td>CF8644</td><td>FRAM</td></tr> <tr><td>CFI-1H08</td><td>INTERFIL</td></tr> <tr><td>24322</td><td>WIX</td></tr> </table>      | CF8644  | FRAM | CFI-1H08   | INTERFIL | 24322  | WIX |
| CF8644  | FRAM   |  |         |      |            |          |        |     |
| CFI-1H08  | INTERFIL   |  |         |      |            |          |        |     |
| 24322   | WIX  |  |         |      |            |          |        |     |
|  <p>28 cm   20 cm   2.6 cm</p> <p>LARGO: 28.0 cm / ANCHO: 20 cm / ALTO: 2.6 cm</p>                                  | <p><b>AUDI</b></p> <p>A3 ATTRACTION 2003-2005 2003-2005 4C 1.8L / TT 2000-2006 4C 1.8L / TT COUPE 2000-2002 4C 1.8L / TT QUATTRO 2000-2006 4C 1.8L / TT QUATTRO 2001-4C 1.8L / TT QUATTRO 2004-2006 6C 3.2L /</p>  | <p><b>JAC1H08CA</b></p> <p>EQUIVALENCIA</p> <table border="1"> <tr><td>CF8644</td><td>FRAM</td></tr> <tr><td>CFI-1H08CA</td><td>INTERFIL</td></tr> <tr><td>24322</td><td>WIX</td></tr> </table>  | CF8644  | FRAM | CFI-1H08CA | INTERFIL | 24322  | WIX |
| CF8644  | FRAM   |  |         |      |            |          |        |     |
| CFI-1H08CA  | INTERFIL   |  |         |      |            |          |        |     |
| 24322   | WIX  |  |         |      |            |          |        |     |
|  <p>28 cm   20.6 cm   3 cm</p> <p>LARGO: 28.0 cm / ANCHO: 20.6 cm / ALTO: 3 cm</p>                                 | <p><b>AUDI</b></p> <p>TT 2000-2006 4C 1.8L /</p>   | <p><b>JAC1J08CA</b></p> <p>EQUIVALENCIA</p> <table border="1"> <tr><td>CF8644</td><td>FRAM</td></tr> <tr><td>CFI-1J08CA</td><td>INTERFIL</td></tr> <tr><td>24322H</td><td>WIX</td></tr> </table> | CF8644  | FRAM | CFI-1J08CA | INTERFIL | 24322H | WIX |
| CF8644  | FRAM   |  |         |      |            |          |        |     |
| CFI-1J08CA  | INTERFIL   |  |         |      |            |          |        |     |
| 24322H  | WIX  |  |         |      |            |          |        |     |
|  <p>28.0 CM   21.0 CM   14.2 CM   5.7 CM   16.0 CM   12.3 CM</p> <p>LARGO: 21 cm / ANCHO: 28 cm / ALTO: 5.7 cm</p> | <p><b>AUDI</b></p> <p>A3 2006-2013 4C 2.0L TURBO / A3 2006-2009 6C 3.2L / Q3 4C 1.4L TURBO / Q3 2015-2019 4C 2.0 L TURBO / TT 2008-2015 4C 2.0L TURBO / TT 2013 5C 2.0L TURBO / TT COUPE 2007-2008 6C 3.2L / TT QUATTRO 2006 4C 1.8L / TT QUATTRO 2009-2015 4C 2.0L TURBO / TT QUATTRO 2012-2013 5C 2.0L TURBO / TTA 2008-2009 6C 3.2L /</p> | <p><b>JAC1K28</b></p> <p>EQUIVALENCIA</p> <table border="1"> <tr><td>CF10373</td><td>FRAM</td></tr> <tr><td>CFI-1K28</td><td>INTERFIL</td></tr> <tr><td>24489</td><td>WIX</td></tr> </table>     | CF10373 | FRAM | CFI-1K28   | INTERFIL | 24489  | WIX |
| CF10373   | FRAM   |  |         |      |            |          |        |     |
| CFI-1K28  | INTERFIL   |  |         |      |            |          |        |     |
| 24489   | WIX  |  |         |      |            |          |        |     |
|  <p>28.0 CM   21.0 CM   5.7 CM   14.2 CM   16.0 CM   12.3 CM</p> <p>LARGO: 21 cm / ANCHO: 28 cm / ALTO: 5.7 cm</p> | <p><b>AUDI</b></p> <p>A3 2006-2013 4C 2.0L TURBO / A3 2006-2009 6C 3.2L / Q3 4C 1.4L TURBO / Q3 2015-2019 4C 2.0 L TURBO / TT 2008-2015 4C 2.0L TURBO / TT 2013 5C 2.0L TURBO / TT COUPE 2007-2008 6C 3.2L / TT QUATTRO 2006 4C 1.8L / TT QUATTRO 2009-2015 4C 2.0L TURBO / TT QUATTRO 2012-2013 5C 2.0L TURBO / TTA 2008-2009 6C 3.2L /</p> | <p><b>JAC1K28CA</b></p> <p>EQUIVALENCIA</p> <table border="1"> <tr><td>CF10373</td><td>FRAM</td></tr> <tr><td>CFI-1K28CA</td><td>INTERFIL</td></tr> <tr><td>24489</td><td>WIX</td></tr> </table> | CF10373 | FRAM | CFI-1K28CA | INTERFIL | 24489  | WIX |
| CF10373   | FRAM   |  |         |      |            |          |        |     |
| CFI-1K28CA  | INTERFIL   |  |         |      |            |          |        |     |
| 24489   | WIX  |  |         |      |            |          |        |     |



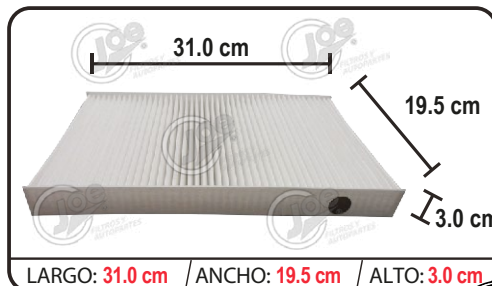

| AUDI  |  | JAC4A08      |                 |
|---|--|--------------|-----------------|
| APLICACIÓN  |  | EQUIVALENCIA |                 |
| A6 AVANT 1999-2000 V6 2.8L / A6 CABRIOLET 1998 V6 2.8L / A6 QUATTRO 2000 V6 2.7L / A6 QUATTRO 2000 V8 4.2L / A6 QUATTRO AVANT 2000 V6 2.8L / A6 QUATTRO 1998-2000 V6 2.8L / |  | CF10560      | <b>FRAM</b>     |
|   |  | CFI-4A08     | <b>INTERFIL</b> |
|   |  | 24866        | <b>WIX</b>      |

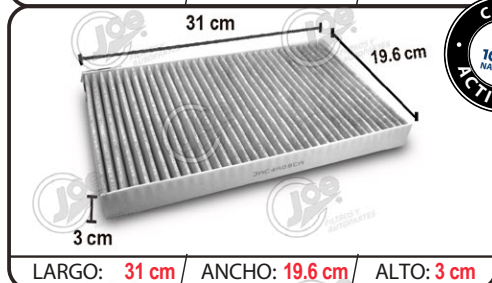

| AUDI  |  | JAC4A08CA    |                 |
|---|--|--------------|-----------------|
| APLICACIÓN  |  | EQUIVALENCIA |                 |
| A6 AVANT 1999-2000 V6 2.8L / A6 CABRIOLET 1998 V6 2.8L / A6 QUATTRO 2000 V6 2.7L / A6 QUATTRO 2000 V8 4.2L / A6 QUATTRO AVANT 2000 V6 2.8L / A6 QUATTRO 1998-2000 V6 2.8L / |  | CF10560      | <b>FRAM</b>     |
|   |  | CFI-4A08     | <b>INTERFIL</b> |
|   |  | 24866        | <b>WIX</b>      |

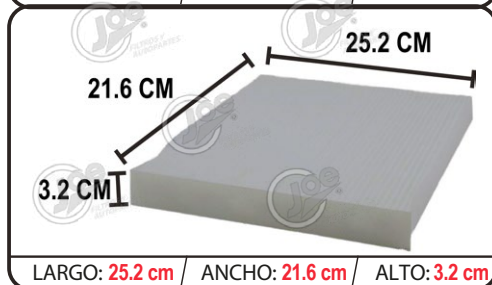

| AUDI  |  | JAC6Q08      |                 |
|---|--|--------------|-----------------|
| APLICACIÓN  |  | EQUIVALENCIA |                 |
| A1 2010-2019 4C 1.4L / A1 2010-2019 4C 1.8L / A3 2013-2019 4C 1.4L / A3 2013-2016 4C 1.8L / A3 2014-2019 4C 2.0 L TURBO / |  | N/D          | <b>FRAM</b>     |
|   |  | CFI-6Q08CA   | <b>INTERFIL</b> |
|   |  | 24517        | <b>WIX</b>      |

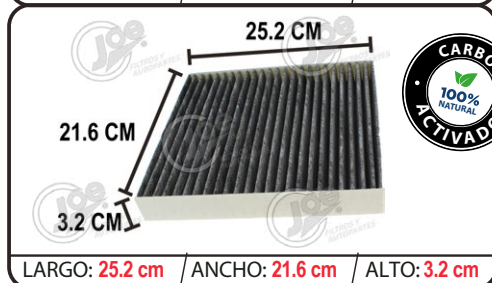

| AUDI  |  | JAC6Q08CA    |                 |
|---|--|--------------|-----------------|
| APLICACIÓN  |  | EQUIVALENCIA |                 |
| A1 2010-2019 4C 1.4L / A1 2010-2019 4C 1.8L / A3 2013-2019 4C 1.4L / A3 2013-2016 4C 1.8L / A3 2014-2019 4C 2.0 L TURBO / |  | N/D          | <b>FRAM</b>     |
|   |  | CFI-6Q08CA   | <b>INTERFIL</b> |
|   |  | 24517        | <b>WIX</b>      |

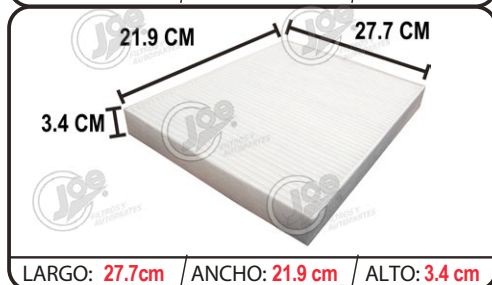

| AUDI   |  | JAC7H08      |                 |
|--|--|--------------|-----------------|
| APLICACIÓN   |  | EQUIVALENCIA |                 |
| Q7 2011-2017 6C 3.0L / Q7 2009-2016 6C 3.0L TURBO DIESEL / Q7 2007-2010 6C 3.6L / Q7 2007-2010 8C 4.2L / |  | CF9881       | <b>FRAM</b>     |
|  |  | CFI-7H08     | <b>INTERFIL</b> |
|  |  | 24631        | <b>WIX</b>      |

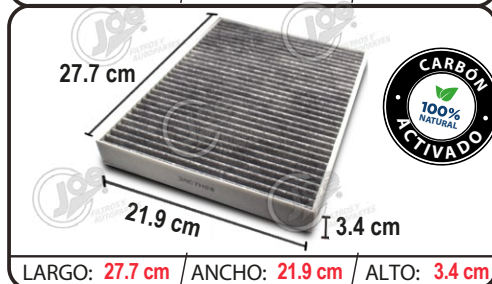

| AUDI   |  | JAC7H08CA    |                 |
|--|--|--------------|-----------------|
| APLICACIÓN   |  | EQUIVALENCIA |                 |
| Q7 2011-2017 6C 3.0L / Q7 2009-2016 6C 3.0L TURBO DIESEL / Q7 2007-2010 6C 3.6L / Q7 2007-2010 8C 4.2L / |  | CF9881       | <b>FRAM</b>     |
|  |  | CFI-7H08     | <b>INTERFIL</b> |
|  |  | 24631        | <b>WIX</b>      |

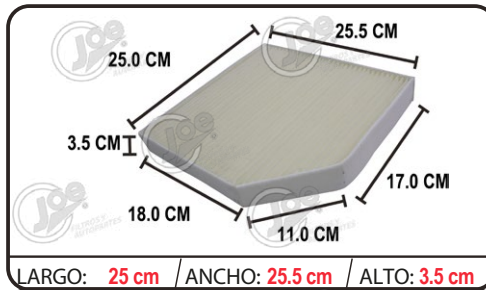

| AUDI  |  | JAC8194      |          |
|---|--|--------------|----------|
| APLICACIÓN  |  | EQUIVALENCIA |          |
| A4 2009-2019 4C 2.0L TURBO / A5 2009-2015 4C 2.0L TURBO / A5 2016 4C 3.0L / A6 2014-2019 4C 2.0L TURBO / A6 2013 4C 2.0L TURBO / A6 2012-2017 4C 3.0L / |  | CF11436      | FRAM     |
|   |  | CFI-8194     | INTERFIL |
|   |  | 24439        | WIX      |

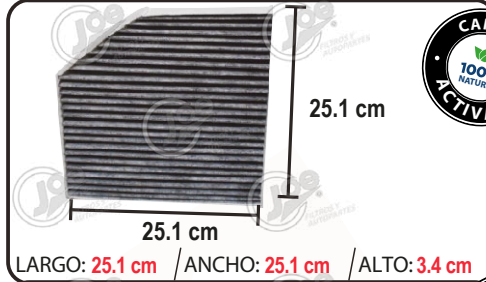

| AUDI  |  | JAC8194CA    |          |
|---|--|--------------|----------|
| APLICACIÓN  |  | EQUIVALENCIA |          |
| A4 2009-2019 4C 2.0L TURBO / A5 2009-2015 4C 2.0L TURBO / A5 2016 4C 3.0L / A6 2014-2019 4C 2.0L TURBO / A6 2013 4C 2.0L TURBO / A6 2012-2017 4C 3.0L / |  | CF11436      | FRAM     |
|   |  | CFI-8194CA   | INTERFIL |
|   |  | 24439        | WIX      |

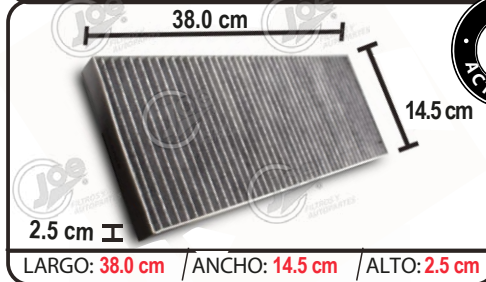

| AUDI  |  | JAC8A08CA    |          |
|---|--|--------------|----------|
| APLICACIÓN  |  | EQUIVALENCIA |          |
| 90 1994-1995 6C 2.1.8L / 90 QUATTRO 1994-1995 6C 2.8L / A4 AVANT 1997-1999 4C 1.8L TURBO / A4 AVANT 2000-2001 4C 1.8L TURBO / A4 AVANT 1996-2001 6C 2.8L / A4 CABRIO CONFORT 2003 6C 2.0L TURBO / A4 CABRIOLET 2005 4C 1.8L / A4 CABRIOLET 1994-1998 6C 2.8L / A4 CONFORT LUXURY 2003-2004 4C 1.8L TURBO / A4 QUATTRO 1997-2001 4C 1.8L TURBO / A4 QUATTRO 1996-2001 6C 2.8L / A4 VANGUARD 2003-2004 4C 1.8L TURBO / S4 2000-2002 6C 2.7L / |  | CFI8110      | FRAM     |
|   |  | CFI-8A08CA   | INTERFIL |
|   |  | 24774        | WIX      |

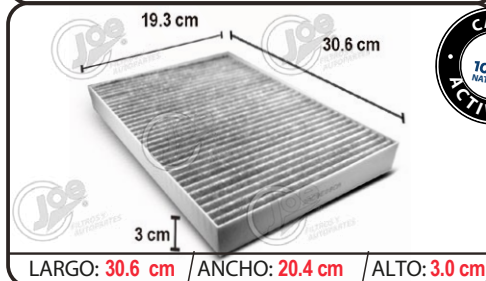

| AUDI   |  | JAC8E08CA    |          |
|--|--|--------------|----------|
| APLICACIÓN   |  | EQUIVALENCIA |          |
| A4 2002-2008 4C 1.8L TURBO / A4 2005-2008 4C 2.0L TURBO / A4 2002-2005 6C 3.0L / A4 2006-2008 6C 3.2L / A6 2001-2004 6C 2.7L BI TURBO / A6 2001 6C 2.8L / A6 2002-2004 6C 3.0L / A6 2001-2004 8C 4.2L / A6 QUATTRO 2002-2004 6C 2.7L / A6 QUATTRO 2001 6C 2.8L / A6QUATTRO 2002-2004 6C 3.0L / A6 QUATTRO 2001-204 8C 4.2L / RS4 2007-2008 8C 4.2L / RS6 2003-2004 8C 4.2L TURBO / S4 2004-2008 8C 4.2L / S6 2002-2003 8C 4.2L / |  | CF10368      | FRAM     |
|  |  | CFI-8E08CA   | INTERFIL |
|  |  | 24765        | WIX      |

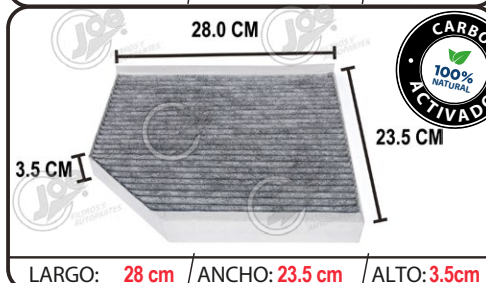

| AUDI   |  | JAC8K08CA    |          |
|--|--|--------------|----------|
| APLICACIÓN   |  | EQUIVALENCIA |          |
| A4 AVANT 2009-2013 4C 2.0L TURBO / A4 AVANT 2009 6C 3.2L / A4 AVANT QUATTRO 2011-2012 4C 2.0L TURBO / A4 QUATTRO 2009-2015 4C 2.0L TURBO / A4 QUATTRO 2009 6C 3.2L / A5 2007 4C 2.0L / A5 CABRIOLET 2010-2013 4C 2.0L TURBO / A5 QUATTRO 2010-2013 4C 2.0 TURBO / A5 2008-2010 6C 3.2L / Q5 2011-2017 4C 2.0 TURBO / Q5 2008-2017 6C 3.0L TURBO DIESEL / Q5 2009-2012 6C 3.2L / Q5 HIBRIDO 2013-2015 4C 2.0L / RS 5 2013-2015 8C 4.2L / S4 2010-2015 6C 3.0L / S5 2010-2015 6C 3.0L / S5 2009-2010 6C 3.2L / S5 2008-2012 8C 4.2L / S5 CABRIOLET 2010-2012 6C 3.0L / |  | CF11179      | FRAM     |
|  |  | CFI-8K08     | INTERFIL |
|  |  | 24227        | WIX      |

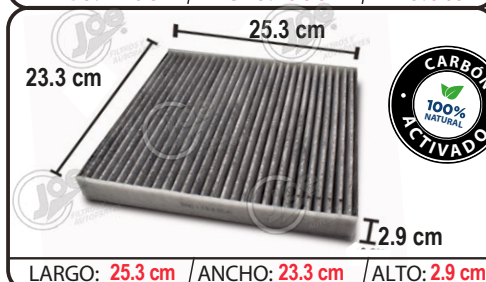

| AUDI                        |  | JAC11643CA   |          |
|-----------------------------|--|--------------|----------|
| APLICACIÓN                  |  | EQUIVALENCIA |          |
| AUDI A3 SPORTBACH 2016-2018 |  | CFA11643     | FRAM     |
|                             |  | N/D          | INTERFIL |
|                             |  | N/D          | WIX      |

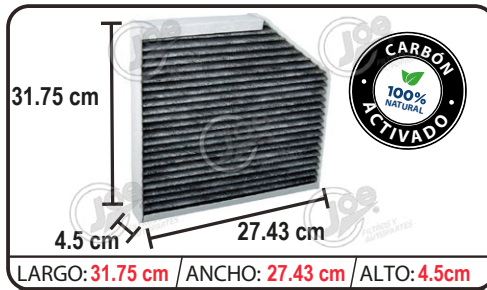

LARGO: 31.75 cm / ANCHO: 27.43 cm / ALTO: 4.5 cm

| AUDI   |  | JAC8419CA    |                 |
|--|--|--------------|-----------------|
| APLICACIÓN   |  | EQUIVALENCIA |                 |
| AUDI A6 2017 4C 1.8L / AUDI A6 2016-2021 4C 2.0L / AUDI A6 2012-2019 V6 3.0L / AUDI A6 QUATTRO 2016-2019 4C 2.0L / AUDI A6 QUATTRO 2014-2019 V6 3.0L |  | N/D          | <b>FRAM</b>     |
|  |  | N/D          | <b>INTERFIL</b> |
|  |  | 24439        | <b>WIX</b>      |



LARGO: 20.4 cm / ANCHO: 18.1 cm / ALTO: 4.0 cm

| BAIC                     |  | JAC7370      |                 |
|--------------------------|--|--------------|-----------------|
| APLICACIÓN               |  | EQUIVALENCIA |                 |
| X-25 2018-2019 4C 1.5L / |  | N/D          | <b>FRAM</b>     |
|                          |  | N/D          | <b>INTERFIL</b> |
|                          |  | N/D          | <b>WIX</b>      |



LARGO: 66.7 cm / ANCHO: 10.4 cm / ALTO: 2.4 cm

| BMW  |  | JAC1899CA    |                 |
|--|--|--------------|-----------------|
| APLICACIÓN   |  | EQUIVALENCIA |                 |
| 320I 2001-2006 6C 2.2L / 323I 2006 6C 2.5L / 325 CI CONVERTIBLE 2001-2004 6C 2.5L / 325I 2001-2005 6C 2.5I / M3 2004-2006 6C 3.0L / M3 2001-2006 6C 3.2L / M3 2001 6C 3.3L / |  | CF10362      | <b>FRAM</b>     |
|  |  | CFI-1899CA   | <b>INTERFIL</b> |
|  |  | 24673        | <b>WIX</b>      |

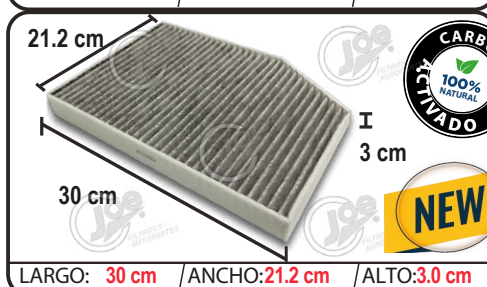

LARGO: 30 cm / ANCHO: 21.2 cm / ALTO: 3.0 cm

| BMW   |  | JACC2205CA   |                 |
|---|--|--------------|-----------------|
| APLICACIÓN  |  | EQUIVALENCIA |                 |
| X3, X4, Z4, 330, 330I, 340, 340I, M340, M340I 2.0L Y 3.0L 2018>2023<br>MANN CUK30007, MAHLE LAK1398, CORTECO 49428005 SAKURA CAC30130 |  | N/D          | <b>FRAM</b>     |
|   |  | N/D          | <b>INTERFIL</b> |
|   |  | WP2205       | <b>WIX</b>      |

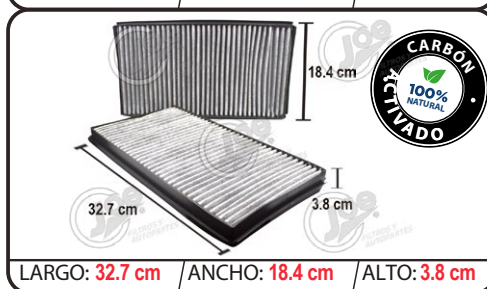

LARGO: 32.7 cm / ANCHO: 18.4 cm / ALTO: 3.8 cm

| BMW   |  | JAC5822CA    |                 |
|---|--|--------------|-----------------|
| APLICACIÓN  |  | EQUIVALENCIA |                 |
| 335I 2008-2010 6C 3.0L TURBO / 525I 2004-2007 6C 2.5L / 528I 2008-2011 6C 3.0L / 530I 2004-2007 6C 3.0L / 545i 2004-2006 8C 4.4L / 550I 2010 8C 4.4L / 550I 2006-2010 8C 4.8L / 645CI COUPE 2004-2005 8C 4.4L / 645CI CONVERTIBLE 2004-2005 8C 4.4L / 650i 2012 8C 4.4L TURBO / 650i 2006-2010 8C 4.8L / 650i CONVERTIBLE 2006-2010 8C 4.8L / M5 2006-2010 10C 5L / M6 2006-2010 10C 5.0L / |  | N/D          | <b>FRAM</b>     |
|   |  | CFI-5822     | <b>INTERFIL</b> |
|   |  | 49374        | <b>WIX</b>      |



LARGO: 26.4 cm / ANCHO: 20 cm / ALTO: 3 cm

| BMW  |  | JAC6411CA    |                 |
|--|--|--------------|-----------------|
| APLICACIÓN   |  | EQUIVALENCIA |                 |
| BMW 528 I MOD. 1997-2000 6 CIL. 2.8 LTS. / BMW 530 I MOD. 2001-2003 6 CIL. 3.0 LTS. / BMW 540 I MOD. 1997-2003 V8 4.4 LTS. / BMW M5 MOD. 2000-2003 V8 5.0 LTS. / |  | CF10369      | <b>FRAM</b>     |
|  |  | CFI-6411CA   | <b>INTERFIL</b> |
|  |  | N/D          | <b>WIX</b>      |



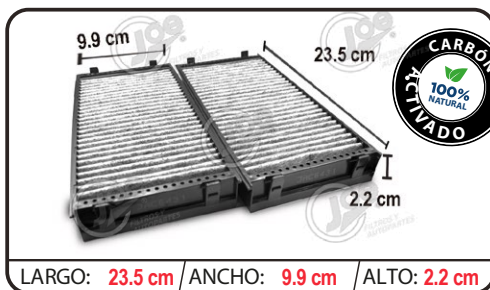

| BMW   |  | JAC6431CA    |          |
|---|--|--------------|----------|
| APLICACIÓN  |  | EQUIVALENCIA |          |
| BMW X5 MOD. 2007-2014 6 CIL. 3.0 LTS. Y 4.4 LTS. /<br>BMW X6 MOD. 2008-2015 6 CIL. 3.0 LTS. / |  | N/D          | FRAM     |
|   |  | CFI-6431     | INTERFIL |
|   |  | 49585        | WIX      |



| BMW   |  | JAC6629CA    |          |
|---|--|--------------|----------|
| APLICACIÓN  |  | EQUIVALENCIA |          |
| 125I 2008-2013 6C 3.0L / 128I 2008-2013 6C 3.0L / 325I SPORT<br>WAGON 2006 6C 2.5L / 325 XI 2005 6C 2.5L / 326 CI 2001 6C<br>2.5L / 327 CI 2002 6C 2.5L / 328 CI 2003 6C 2.5L / 328I<br>2010-2012 6C 3.0L / 329 CI 2004 6C 2.5L / 330 CI 2005 6C 2.5L<br>/ 335I 2007-2015 6C 3.0L TURBO / X1 2013 3C 3.0L / X1<br>2013-2015 4C 2.0L / X1 2014 4C 3.0L / X1 2015 5C 3.0L / |  | CF10727      | FRAM     |
|   |  | CFI-6629CA   | INTERFIL |
|   |  | 49371        | WIX      |

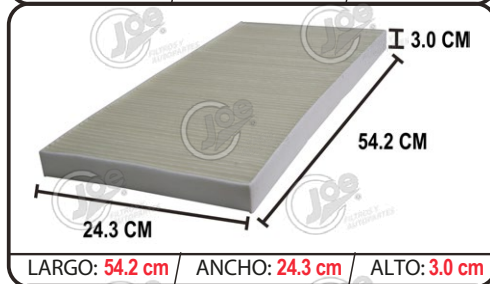

| BMW  |  | JAC9044      |          |
|--|--|--------------|----------|
| APLICACIÓN   |  | EQUIVALENCIA |          |
| X3 2006 6C 3.0L / X5 2000-2006 8C 4.4L / X5 2004-2005 8C<br>4.8L / X6 2006 8C 4.8L / |  | CF10830      | FRAM     |
|  |  | CFI-9044     | INTERFIL |
|  |  | 24827        | WIX      |

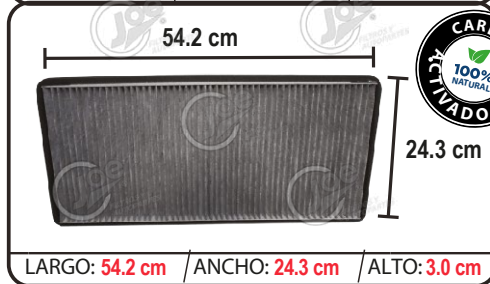

| BMW  |  | JAC9044CA    |          |
|--|--|--------------|----------|
| APLICACIÓN   |  | EQUIVALENCIA |          |
| X3 2006 6C 3.0L / X5 2000-2006 8C 4.4L / X5 2004-2005 8C<br>4.8L / X6 2006 8C 4.8L / |  | CF10830      | FRAM     |
|  |  | CFI-9044CA   | INTERFIL |
|  |  | 24827        | WIX      |

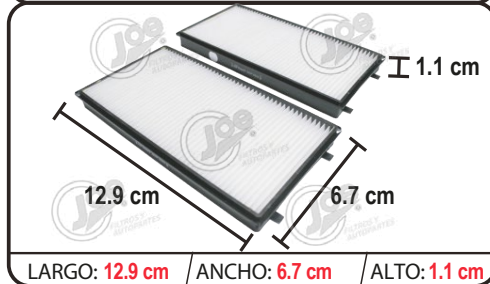

| BMW  |  | JAC10937     |          |
|--|--|--------------|----------|
| APLICACIÓN   |  | EQUIVALENCIA |          |
| 745I 2002-2005 6C 4.4L / 745LI 2002-2005 8C 4.4L / 750I<br>2006-2007 8C 4.8L / 750LI 2006-2008 8C 4.8L / 760I<br>2004-2006 12C 6.0L / 760LI 12C 6.0L / |  | CF10937      | FRAM     |
|  |  | N/D          | INTERFIL |
|  |  | 49360        | WIX      |



| BMW  |  | JAC11471CA    |      |
|--|--|---------------|------|
| APLICACIÓN   |  | EQUIVALENCIA  |      |
| BMW X3 4 CIL. 2,0 LTS. MOD. 2013-2017 / X3 6 CIL. 3,0<br>LTS. MOD. 2016-2018 |  | CFA-11471-2CA | FRAM |
|  |  |               | MAAN |
|  |  |               | WIX  |

|   |  |   |           |      |          |          |       |     |
|---|--|---|-----------|------|----------|----------|-------|-----|
| <p>164 cm / 90 cm / 30 cm</p> <p>16.4 cm / 9 cm / 3 cm</p>                              | <p><b>BMW</b></p> <p><b>APLICACIÓN</b></p> <p>BMW X3 MOD. 2009-20017 / BMW X4 MOD. 2003-2018</p>   | <p><b>JAC11532CA</b></p> <p><b>EQUIVALENCIA</b></p> <table border="1"> <tr><td>CF11532-2</td><td>FRAM</td></tr> <tr><td></td><td>MAAN</td></tr> <tr><td></td><td>WIX</td></tr> </table>             | CF11532-2 | FRAM |          | MAAN     |       | WIX |
| CF11532-2   | FRAM   |   |           |      |          |          |       |     |
|   | MAAN   |   |           |      |          |          |       |     |
|   | WIX  |   |           |      |          |          |       |     |
| <p>19.1 CM / 19.1 CM / 3.0 CM</p> <p>LARGO: 29.5 cm / ANCHO: 19.1 cm / ALTO: 3.0 cm</p> | <p><b>BUICK</b></p> <p><b>APLICACIÓN</b></p> <p>BUICK CENTURY 1997-2005 6C 3.1L / BUICK LACROSSE 2005-2008 6C 3.6L / BUICK LACROSSE 2005-2008 8C 3.8L / BUICK LACROSSE 2008-2009 8C 5.3L / BUICK REGAL 1997-2004 8C 3.8L /</p> <p><b>JAC1026</b></p> <p><b>EQUIVALENCIA</b></p> <table border="1"> <tr><td>CF8392</td><td>FRAM</td></tr> <tr><td></td><td>INTERFIL</td></tr> <tr><td></td><td>WIX</td></tr> </table>   |   | CF8392    | FRAM |          | INTERFIL |       | WIX |
| CF8392  | FRAM   |   |           |      |          |          |       |     |
|   | INTERFIL   |   |           |      |          |          |       |     |
|   | WIX  |   |           |      |          |          |       |     |
| <p>23.0 CM / 11.5 CM / 3.9 CM</p> <p>LARGO 23 cm / ANCHO: 11.5 cm / ALTO: 3.9 cm</p>    | <p><b>BUICK</b></p> <p><b>APLICACIÓN</b></p> <p>BUICK TERRAZA 2005-2006 6C 3.5L / BBUICK TERRAZA 2006-2007 6C 3.9L /</p>   | <p><b>JAC1030</b></p> <p><b>EQUIVALENCIA</b></p> <table border="1"> <tr><td>CF10136</td><td>FRAM</td></tr> <tr><td>CFI-1030</td><td>INTERFIL</td></tr> <tr><td>24161</td><td>WIX</td></tr> </table> | CF10136   | FRAM | CFI-1030 | INTERFIL | 24161 | WIX |
| CF10136   | FRAM   |   |           |      |          |          |       |     |
| CFI-1030  | INTERFIL   |   |           |      |          |          |       |     |
| 24161   | WIX  |   |           |      |          |          |       |     |
| <p>23.0 cm / 11.5 cm / 3.9 cm</p> <p>LARGO: 23 cm / ANCHO: 11.5 cm / ALTO: 3.9 cm</p>   | <p><b>BUICK</b></p> <p><b>APLICACIÓN</b></p> <p>BUICK TERRAZA 2005-2006 6C 3.5L / BBUICK TERRAZA 2006-2007 6C 3.9L /</p> <p><b>JAC1030CA</b></p> <p><b>EQUIVALENCIA</b></p> <table border="1"> <tr><td>CF10136</td><td>FRAM</td></tr> <tr><td>CFI-1030</td><td>INTERFIL</td></tr> <tr><td>24161</td><td>WIX</td></tr> </table>   |   | CF10136   | FRAM | CFI-1030 | INTERFIL | 24161 | WIX |
| CF10136   | FRAM   |   |           |      |          |          |       |     |
| CFI-1030  | INTERFIL   |   |           |      |          |          |       |     |
| 24161   | WIX  |   |           |      |          |          |       |     |
| <p>3.6 CM / 24.0 CM / 20.5 CM</p> <p>LARGO: 24 cm / ANCHO: 20.5 cm / ALTO: 3.6 cm</p>   | <p><b>BUICK</b></p> <p><b>APLICACIÓN</b></p> <p>BUICK ELR HIBRIDO 2014-2015 4C 1.4L / BUICK ENCLAVE 2018-2019 6C 3.6L / BUICK ENCORE 4C 1.4 TURBO / BUICK ENVISION 2017-2019 4C 2.5L / BUICK LACROSSE 2017-2019 4C 2.5L / BUICK LACROSSE 2010-2015 4C 2.4L / BUICK LACROSSE 2010-2015 6C 3.6L / BUICK LACROSSE HIBRIDO 2012-2015 4C 2.4L / BUICK REGAL 2011-2019 4C 2.0L / BUICK REGAL 2011-2012 6C 2.4L / BUICK REGAL HIBRIDO 2012-2015 4C 2.4L / BUICK 2012-2015 6C 3.6L / BUICK VERANO 2013-2016 6C 2.0L / BUICK VERANO 2012-2016 4C 2.4L /</p>   | <p><b>JAC1327</b></p> <p><b>EQUIVALENCIA</b></p> <table border="1"> <tr><td>CF10775</td><td>FRAM</td></tr> <tr><td>CFI-1327</td><td>INTERFIL</td></tr> <tr><td>24191</td><td>WIX</td></tr> </table> | CF10775   | FRAM | CFI-1327 | INTERFIL | 24191 | WIX |
| CF10775   | FRAM   |   |           |      |          |          |       |     |
| CFI-1327  | INTERFIL   |   |           |      |          |          |       |     |
| 24191   | WIX  |   |           |      |          |          |       |     |
| <p>24.0 CM / 20.5 CM / 3.6 CM</p> <p>LARGO: 24 cm / ANCHO: 20.5 cm / ALTO: 3.6 cm</p>   | <p><b>BUICK</b></p> <p><b>APLICACIÓN</b></p> <p>BUICK ELR HIBRIDO 2014-2015 4C 1.4L / BUICK ENCLAVE 2018-2019 6C 3.6L / BUICK ENCORE 4C 1.4 TURBO / BUICK ENVISION 2017-2019 4C 2.5L / BUICK LACROSSE 2017-2019 4C 2.5L / BUICK LACROSSE 2010-2015 4C 2.4L / BUICK LACROSSE 2010-2015 6C 3.6L / BUICK LACROSSE HIBRIDO 2012-2015 4C 2.4L / BUICK REGAL 2011-2019 4C 2.0L / BUICK REGAL 2011-2012 6C 2.4L / BUICK REGAL HIBRIDO 2012-2015 4C 2.4L / BUICK 2012-2015 6C 3.6L / BUICK VERANO 2013-2016 6C 2.0L / BUICK VERANO 2012-2016 4C 2.4L /</p> <p><b>JAC1327CA</b></p> <p><b>EQUIVALENCIA</b></p> <table border="1"> <tr><td>CF10775</td><td>FRAM</td></tr> <tr><td>CFI-1327</td><td>INTERFIL</td></tr> <tr><td>24191</td><td>WIX</td></tr> </table> |   | CF10775   | FRAM | CFI-1327 | INTERFIL | 24191 | WIX |
| CF10775   | FRAM   |   |           |      |          |          |       |     |
| CFI-1327  | INTERFIL   |   |           |      |          |          |       |     |
| 24191   | WIX  |   |           |      |          |          |       |     |



| BUICK  |  | JAC1350      |          |
|--|--|--------------|----------|
| APLICACIÓN   |  | EQUIVALENCIA |          |
| BUICK ENVISION 2016-2017 4C 2.0L / BUICK LACROSSE 2017 6C 3.6L / |  | CF11966      | FRAM     |
|  |  | CFI-1350     | INTERFIL |
|  |  | 24211        | WIX      |



| BUICK  |  | JAC1350CA    |          |
|--|--|--------------|----------|
| APLICACIÓN   |  | EQUIVALENCIA |          |
| BUICK ENVISION 2016-2017 4C 2.0L / BUICK LACROSSE 2017 6C 3.6L / |  | CF11966      | FRAM     |
|  |  | CFI-1350     | INTERFIL |
|  |  | 24211        | WIX      |

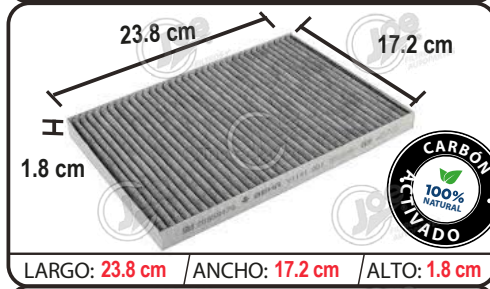

| BUICK                               |  | JAC11663CA   |          |
|-------------------------------------|--|--------------|----------|
| APLICACIÓN                          |  | EQUIVALENCIA |          |
| BUICK ENCLAVE 2008-2015 V6 3.6 LTS. |  | CF11663      | FRAM     |
|                                     |  | CF-11663     | INTERFIL |
|                                     |  | N/D          | WIX      |



| CADILLAC  |  | JAC1327      |          |
|---|--|--------------|----------|
| APLICACIÓN  |  | EQUIVALENCIA |          |
| CTS 2014-2015 4C 1.4L / SRC 2012-2015 6C 3.0L / SRX 2010-2011 6C 2.8L TURBO / SRX 2010-2013 6C 3.0L / |  | CF10775      | FRAM     |
|   |  | CFI-1327     | INTERFIL |
|   |  | 24191        | WIX      |

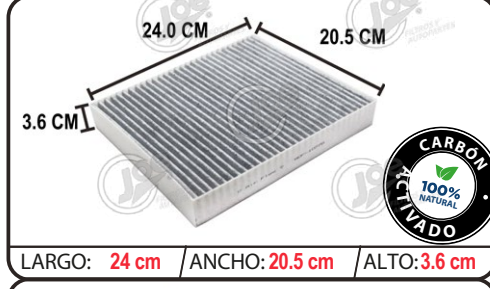

| CADILLAC  |  | JAC1327CA    |          |
|---|--|--------------|----------|
| APLICACIÓN  |  | EQUIVALENCIA |          |
| CTS 2014-2015 4C 1.4L / SRC 2012-2015 6C 3.0L / SRX 2010-2011 6C 2.8L TURBO / SRX 2010-2013 6C 3.0L / |  | CF10775      | FRAM     |
|   |  | CFI-1327     | INTERFIL |
|   |  | 24191        | WIX      |

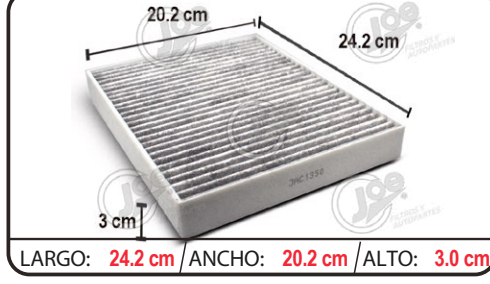

| CADILLAC  |  | JAC1350      |          |
|---|--|--------------|----------|
| APLICACIÓN  |  | EQUIVALENCIA |          |
| ATS 2014-2019 4C 2.0L / ATS 2014-2019 4C 2.0L / ATS 2013-2019 6C 3.6L / CTS 2015-2019 4C 2.0L / CTS 2015-2019 6C 3.6L / CTS 2016-2019 8C 6.2L / |  | CF11966      | FRAM     |
|   |  | CFI-1350     | INTERFIL |
|   |  | 24211        | WIX      |

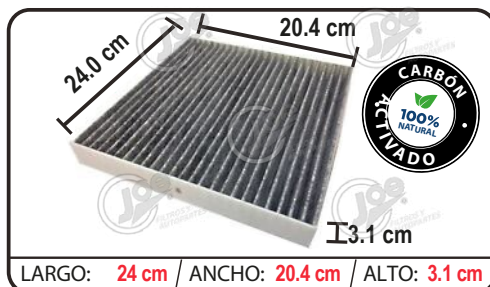

| CADILLAC   |  | JAC1350CA    |          |
|--|--|--------------|----------|
| APLICACIÓN   |  | EQUIVALENCIA |          |
| ATS 2014-2019 4C 2.0L / ATS 2014-2019 4C 2.0L / ATS 2013-2019 6C 3.6L / CTS 215-2019 4C 2.0L / CTS 2015-2019 6C 3.6L / CTS 2016-2019 8C 6.2L / |  | CF11966      | FRAM     |
|  |  | CFI-1350     | INTERFIL |
|  |  | 24211        | WIX      |



| CADILLAC      |  | JAC1808      |          |
|---------------|--|--------------|----------|
| APLICACIÓN    |  | EQUIVALENCIA |          |
| BLS 4C 2.0L / |  | CF11669      | FRAM     |
|               |  | CFI-1808     | INTERFIL |
|               |  | 24472        | WIX      |

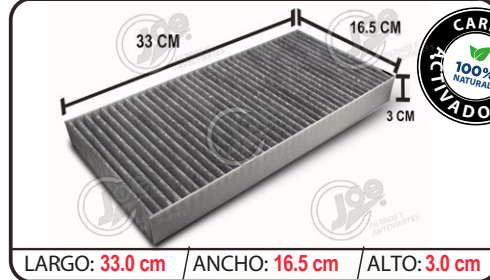

| CADILLAC      |  | JAC1808CA    |          |
|---------------|--|--------------|----------|
| APLICACIÓN    |  | EQUIVALENCIA |          |
| BLS 4C 2.0L / |  | 11669        | FRAM     |
|               |  | CFI-1808CA   | INTERFIL |
|               |  | 24472        | WIX      |

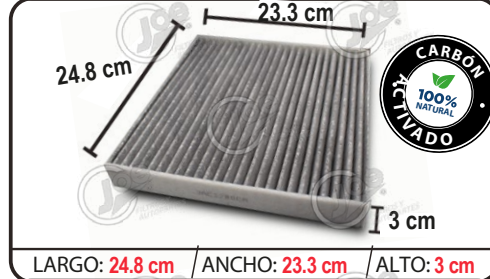

| CADILLAC                     |  | JAC2280CA    |          |
|------------------------------|--|--------------|----------|
| APLICACIÓN                   |  | EQUIVALENCIA |          |
| ESCALADE 2015-2019 8C 6.2L / |  | N/D          | FRAM     |
|                              |  | CFI-2280     | INTERFIL |
|                              |  | WP10129      | WIX      |

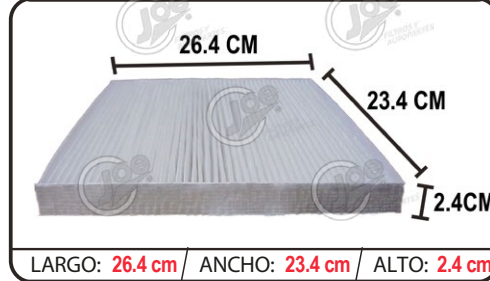

| CADILLAC   |  | JAC8898      |          |
|--|--|--------------|----------|
| APLICACIÓN   |  | EQUIVALENCIA |          |
| ESCALADE 2003-2005 8C 5.3L / ESCALADE ESV 2003-2006 8C 6.0L / ESCALADE EXT 2003-2006 8C 6.0L / |  | CF10360      | FRAM     |
|  |  | CFI-8898     | INTERFIL |
|  |  | 24814        | WIX      |

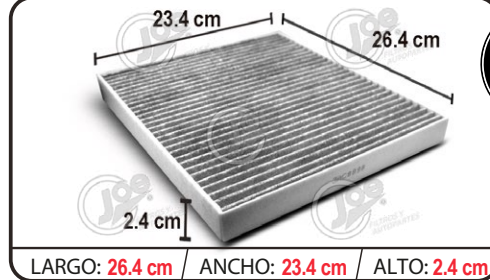

| CADILLAC   |  | JAC8898CA    |          |
|--|--|--------------|----------|
| APLICACIÓN   |  | EQUIVALENCIA |          |
| ESCALADE 2003-2005 8C 5.3L / ESCALADE ESV 2003-2006 8C 6.0L / ESCALADE EXT 2003-2006 8C 6.0L / |  | CF10360      | FRAM     |
|  |  | CFI-8898     | INTERFIL |
|  |  | 24814        | WIX      |

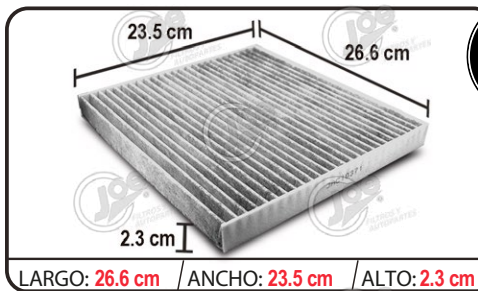

## CADILLAC

## JAC10371CA

### APLICACIÓN

### EQUIVALENCIA

CTS 2014 4C 2.0L / CTS 2005-2014 6C 2.8L / CTS 2003-2014 6C 3.6L / CTS 2004-2005 8C 5.7L / CTS 2006-2007 8C 6.0L / CTS 2009-2015 8C 6.2L / SRX 2004-2009 6C 3.6L / SRX 2004-2009 8C 4.0L / STS 2008-2011 6C 3.6L / STS 2008-2010 8C 4.6L /

CF10371

FRAM

CFI-10371

INTERFIL

24869

WIX



## CHEVROLET

## JAC1026

### APLICACIÓN

### EQUIVALENCIA

IMPALA 2000-2005 6C 3.4L / IMPALA 2006-2011 6C 3.5L / IMPALA 2004-2005 6C 3.8L / IMPALA 2006-2011 6C 3.9L / IMPALA 2000-2003 8C 3.8L / IMPALA 2006-2009 8C 5.3L / IMPALA LIMITED 2012-2016 6C 3.6L / MONTE CARLO 1998 6C 3.1L / MONTE CARLO 2000-2005 6C 3.4L /

CF8392

FRAM

CFI-1026

INTERFIL

24780

WIX



## CHEVROLET

## JAC1030

### APLICACIÓN

### EQUIVALENCIA

UPLANDER 2004-2006 6C 3.5L / UPLANDER 2006-2009 6C 3.9L /

CF10136

FRAM

CFI-1030

INTERFIL

24161

WIX

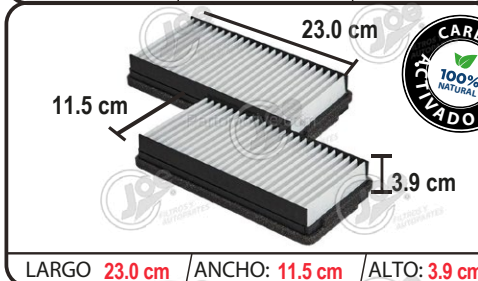

## CHEVROLET

## JAC1030CA

### APLICACIÓN

### EQUIVALENCIA

UPLANDER 2004-2006 6C 3.5L / UPLANDER 2006-2009 6C 3.9L /

CF10136

FRAM

CFI-1030

INTERFIL

24161

WIX



## CHEVROLET

## JAC1327

### APLICACIÓN

### EQUIVALENCIA

BEAT 2018-2019 4C 1.6L / CRUZE 2011-2015 4C 1.8L / CRUZE 2011-2016 4C 1.8L TURBO / CRUZE 2012-2014 4C 2.0L TURBO DIESEL / EQUINOX 2018-2019 4C 1.5L TURBO / MALIBU 2013-2015 4C 2.0L TURBO / MALIBU 2013-2015 4C 2.5L / CHEVROLET MALIBU HIBRIDO 2013-2014 4C 2.4L / ORLANDO 2012-2014 4C 2.4L / SONIC 2012-2015 4C 1.6L / SONIC 2012-2017 4C 1.8L / SONIC RS 2013-2016 4C 1.4L TURBO / SPARK 2013-2015 4C 1.2L / SPARK 2016-2017 4C 1.4L / TRAX 2013-2015 4C 1.4 TURBO / TRAX 2013-2017 4C 1.8L / VOLT 2011-2015 4C 1.4L / VOLT 2016-2017 4C 1.5L /

CF10775

FRAM

CFI-1327

INTERFIL

24191

WIX

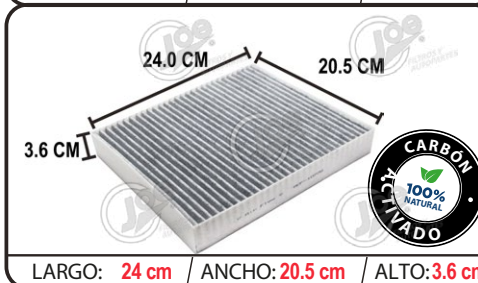

## CHEVROLET

## JAC1327CA

### APLICACIÓN

### EQUIVALENCIA

BEAT 2018-2019 4C 1.6L / CRUZE 2011-2015 4C 1.8L / CRUZE 2011-2016 4C 1.8L TURBO / CRUZE 2012-2014 4C 2.0L TURBO DIESEL / EQUINOX 2018-2019 4C 1.5L TURBO / MALIBU 2013-2015 4C 2.0L TURBO / MALIBU 2013-2015 4C 2.5L / CHEVROLET MALIBU HIBRIDO 2013-2014 4C 2.4L / ORLANDO 2012-2014 4C 2.4L / SONIC 2012-2015 4C 1.6L / SONIC 2012-2017 4C 1.8L / SONIC RS 2013-2016 4C 1.4L TURBO / SPARK 2013-2015 4C 1.2L / SPARK 2016-2017 4C 1.4L / TRAX 2013-2015 4C 1.4 TURBO / TRAX 2013-2017 4C 1.8L / VOLT 2011-2015 4C 1.4L / VOLT 2016-2017 4C 1.5L /

CF10775

FRAM

CFI-1327

INTERFIL

24191

WIX



LARGO: 22.5 cm / ANCHO: 19.2 cm / ALTO: 2.9 cm

| CHEVROLET                                     | JAC1332      |                 |
|---|--------------|-----------------|
| APLICACIÓN                                    | EQUIVALENCIA |                 |
| CHEVROLET AVEO 4 CIL. 1.5 LTS. MOD. 2018-2019 | N/D          | <b>FRAM</b>     |
|   | CFI-1332     | <b>INTERFIL</b> |
|   | WP10155      | <b>WIX</b>      |

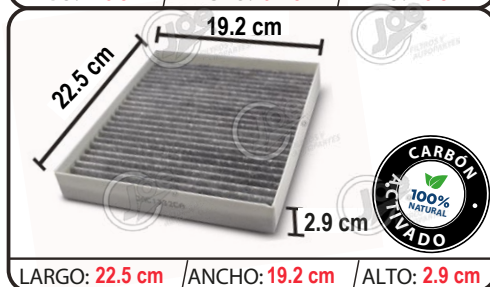

LARGO: 22.5 cm / ANCHO: 19.2 cm / ALTO: 2.9 cm

| CHEVROLET                                     | JAC1332CA    |                 |
|---|--------------|-----------------|
| APLICACIÓN                                    | EQUIVALENCIA |                 |
| CHEVROLET AVEO 4 CIL. 1.5 LTS. MOD. 2018-2019 | N/D          | <b>FRAM</b>     |
|   | CFI-1332     | <b>INTERFIL</b> |
|   | WP10155      | <b>WIX</b>      |

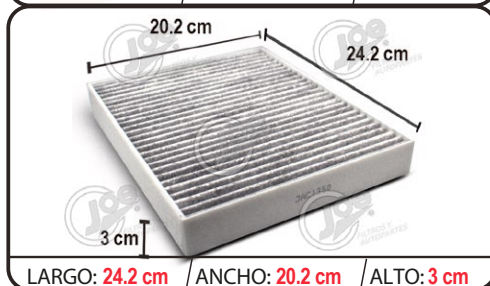

LARGO: 24.2 cm / ANCHO: 20.2 cm / ALTO: 3 cm

| CHEVROLET  | JAC1350      |                 |
|--|--------------|-----------------|
| APLICACIÓN   | EQUIVALENCIA |                 |
| CAMARO 2017-2018 4C 2.0L TURBO / CAMARO 2016-2018 6C 3.6L / CAMARO 2016-2018 8C 6.2L / COLORADO 2015-2019 4C 2.5L / COLORADO 2015-2019 4C 3.6L / CRUZE 2017-2019 4C 1.4L TURBO / IMPALA 2014-2015 4C 2.4L / IMPALA 2014-2017 4C 2.5L / IMPALA 2014-2016 6C 3.6L / MALIBU 2016-2017 4C 1.5L / MALIBU 2016-2017 4C 1.8L / MALIBU 4C 2.0L TURBO / | CF11966      | <b>FRAM</b>     |
|  | CFI-1350     | <b>INTERFIL</b> |
|  | 24211        | <b>WIX</b>      |

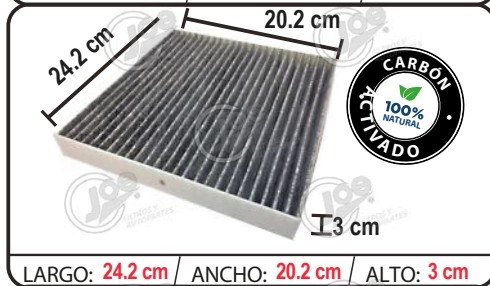

LARGO: 24.2 cm / ANCHO: 20.2 cm / ALTO: 3 cm

| CHEVROLET  | JAC1350CA    |                 |
|--|--------------|-----------------|
| APLICACIÓN   | EQUIVALENCIA |                 |
| CAMARO 2017-2018 4C 2.0L TURBO / CAMARO 2016-2018 6C 3.6L / CAMARO 2016-2018 8C 6.2L / COLORADO 2015-2019 4C 2.5L / COLORADO 2015-2019 4C 3.6L / CRUZE 2017-2019 4C 1.4L TURBO / IMPALA 2014-2015 4C 2.4L / IMPALA 2014-2017 4C 2.5L / IMPALA 2014-2016 6C 3.6L / MALIBU 2016-2017 4C 1.5L / MALIBU 2016-2017 4C 1.8L / MALIBU 4C 2.0L TURBO / | CF11966      | <b>FRAM</b>     |
|  | CFI-1350     | <b>INTERFIL</b> |
|  | 24211        | <b>WIX</b>      |



LARGO: 33.0 cm / ANCHO: 16.5 cm / ALTO: 3.0 cm

| CHEVROLET  | JAC1808      |                 |
|--|--------------|-----------------|
| APLICACIÓN   | EQUIVALENCIA |                 |
| CHEVY C2 2004-2008 4C 1.6L / CHEVY MONZA 2002-2003 4C 1.6L / CHEVY PICK UP 2003 4C 1.6L / CHEVY POP 2002-2003 4C 1.6L / CHEVY POP 2003 4C 1.6L / CHEVY SWING 2002-2003 4C 1.4L / CHEVY SWING 2003 4C 1.6L / CORSA 2002-2008 4C 1.8L / MERIVA 2003-2008 4C 1.8L / TORNADO 2004-2006 4C 1.8L / VECTRA 2003-2006 4C 2.2L / VECTRA 2003-2006 4C 3.2L / | CF11669      | <b>FRAM</b>     |
|  | CFI-1808     | <b>INTERFIL</b> |
|  | 24472        | <b>WIX</b>      |



LARGO: 33.0 cm / ANCHO: 16.5 cm / ALTO: 3.0 cm

| CHEVROLET  | JAC1808CA    |                 |
|--|--------------|-----------------|
| APLICACIÓN   | EQUIVALENCIA |                 |
| CHEVY C2 2004-2008 4C 1.6L / CHEVY MONZA 2002-2003 4C 1.6L / CHEVY PICK UP 2003 4C 1.6L / CHEVY POP 2002-2003 4C 1.6L / CHEVY POP 2003 4C 1.6L / CHEVY SWING 2002-2003 4C 1.4L / CHEVY SWING 2003 4C 1.6L / CORSA 2002-2008 4C 1.8L / MERIVA 2003-2008 4C 1.8L / TORNADO 2004-2006 4C 1.8L / VECTRA 2003-2006 4C 2.2L / VECTRA 2003-2006 4C 3.2L / | 11669        | <b>FRAM</b>     |
|  | CFI-1808CA   | <b>INTERFIL</b> |
|  | 24472        | <b>WIX</b>      |

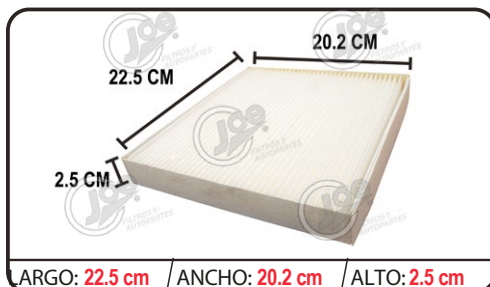

LARGO: 22.5 cm / ANCHO: 20.2 cm / ALTO: 2.5 cm

| CHEVROLET                                     | JAC2101             |
|---|---------------------|
| APLICACIÓN                                    | EQUIVALENCIA        |
| CHEVROLET AVEO 4 CIL. 1.5 LTS. MOD. 2018-2019 | N/D <b>FRAM</b>     |
|   | N/D <b>INTERFIL</b> |
|   | N/D <b>WIX</b>      |

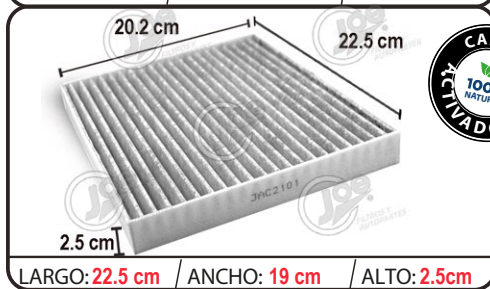

LARGO: 22.5 cm / ANCHO: 19 cm / ALTO: 2.5 cm

| CHEVROLET                                     | JAC2101CA           |
|---|---------------------|
| APLICACIÓN                                    | EQUIVALENCIA        |
| CHEVROLET AVEO 4 CIL. 1.5 LTS. MOD. 2018-2019 | N/D <b>FRAM</b>     |
|   | N/D <b>INTERFIL</b> |
|   | N/D <b>WIX</b>      |



LARGO: 42.3 cm / ANCHO: 11.0 cm / ALTO: 3.1 cm

| CHEVROLET  | JAC2272CA                |
|--|--------------------------|
| APLICACIÓN   | EQUIVALENCIA             |
| CHEVROLET EQUINOX MOD. 2005-2008 6 CIL. 3.4 LTS. / CHEVROLET EQUINOX MOD. 2008-2009 6 CIL. 3.6 LTS | CF10141 <b>FRAM</b>      |
|  | CFI-2272 <b>INTERFIL</b> |
|  | 24872 <b>WIX</b>         |



LARGO: 24.8 cm / ANCHO: 23.3 cm / ALTO: 3 cm

| CHEVROLET   | JAC2280CA                |
|---|--------------------------|
| APLICACIÓN  | EQUIVALENCIA             |
| CHEYENNE 2015-2019 8C 5.3L / SILVERADO 2015-2019 8C 4.3L / SILVERADO 2015-2019 8C 5.3L / SUBURBAN 2015-2017 8C 5.3L / TAHOE 2015-2019 8C 5.3L / | N/D <b>FRAM</b>          |
|   | CFI-2280 <b>INTERFIL</b> |
|   | WP10129 <b>WIX</b>       |

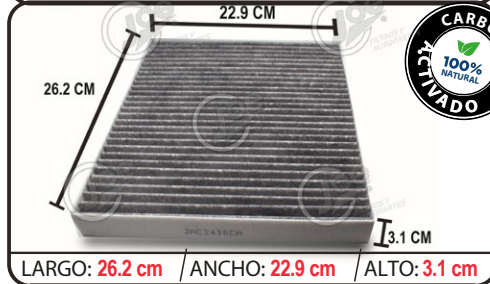



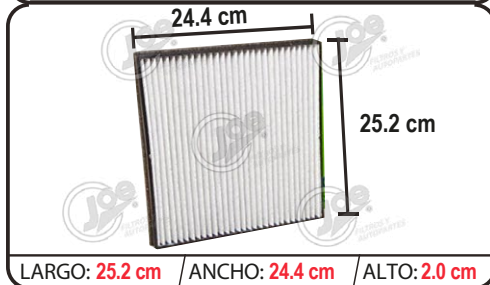

LARGO: 26.2 cm / ANCHO: 22.9 cm / ALTO: 3.1 cm

| CHEVROLET   | JAC2436CA                |
|---|--------------------------|
| APLICACIÓN  | EQUIVALENCIA             |
| ZAFIRA 2002-2005 4C 1.8L / ZAFIRA 2002-2005 4C 2.0L / | N/D <b>FRAM</b>          |
|   | CFI-2436 <b>INTERFIL</b> |
|   | 6918 <b>WIX</b>          |

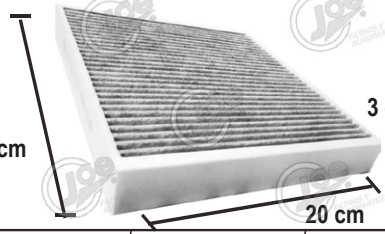
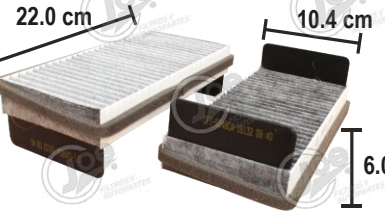

LARGO: 25.2 cm / ANCHO: 24.4 cm / ALTO: 2.0 cm

| CHEVROLET   | JAC3471                  |
|---|--------------------------|
| APLICACIÓN  | EQUIVALENCIA             |
| CAMARO 2010-2015 6C 3.6L / CAMARO 2010-2015 6C 6.2L / | 11667 <b>FRAM</b>        |
|   | CFI-3471 <b>INTERFIL</b> |
|   | 24104 <b>WIX</b>         |

|  |   |  |         |      |            |          |       |     |
|--|---|--|---------|------|------------|----------|-------|-----|
|  <p>24.4 cm<br/>25.2 cm</p> <p><b>CARBÓN ACTIVADO</b><br/>100% NATURAL</p> <p>LARGO: 25.2 cm / ANCHO: 24.4 cm / ALTO: 2.0 cm</p>              | <p><b>CHEVROLET</b></p> <p>APLICACIÓN</p> <p>CAMARO 2010-2015 6C 3.6L / CAMARO 2010-2015 6C 6.2L /</p>  | <p><b>JAC3471CA</b></p> <p>EQUIVALENCIA</p> <table border="1"> <tr><td>11667</td><td>FRAM</td></tr> <tr><td>CFI-3471</td><td>INTERFIL</td></tr> <tr><td>24104</td><td>WIX</td></tr> </table>   | 11667   | FRAM | CFI-3471   | INTERFIL | 24104 | WIX |
| 11667  | FRAM  |  |         |      |            |          |       |     |
| CFI-3471   | INTERFIL  |  |         |      |            |          |       |     |
| 24104  | WIX   |  |         |      |            |          |       |     |
|  <p>21.0 CM<br/>23.1 CM<br/>3.0 CM</p> <p><b>CARBÓN ACTIVADO</b><br/>100% NATURAL</p> <p>LARGO: 23.1 cm / ANCHO: 21 cm / ALTO: 3 cm</p>       | <p><b>CHEVROLET</b></p> <p>APLICACIÓN</p> <p>COLORADO 4 CIL. 2.5 LTS. MOD. 2015-2019 / COLORADO V6 3.6 LTS. MOD. 2015-2019</p>  | <p><b>JAC5206CA</b></p> <p>EQUIVALENCIA</p> <table border="1"> <tr><td></td><td>FRAM</td></tr> <tr><td>CFI-5206</td><td>INTERFIL</td></tr> <tr><td></td><td>WIX</td></tr> </table>             |         | FRAM | CFI-5206   | INTERFIL |       | WIX |
|  | FRAM  |  |         |      |            |          |       |     |
| CFI-5206   | INTERFIL  |  |         |      |            |          |       |     |
|  | WIX   |  |         |      |            |          |       |     |
|  <p>22 cm<br/>20 cm<br/>3 cm</p> <p>LARGO: 22 cm / ANCHO: 20 cm / ALTO: 3 cm</p>   | <p><b>CHEVROLET</b></p> <p>APLICACIÓN</p> <p>CHEVROLET S10 2012&gt; TRAIBLAZER</p>  | <p><b>JAC5210</b></p> <p>EQUIVALENCIA</p> <table border="1"> <tr><td></td><td>FRAM</td></tr> <tr><td>CU2144</td><td>MANN</td></tr> <tr><td></td><td>WIX</td></tr> </table>                     |         | FRAM | CU2144     | MANN     |       | WIX |
|  | FRAM  |  |         |      |            |          |       |     |
| CU2144   | MANN  |  |         |      |            |          |       |     |
|  | WIX   |  |         |      |            |          |       |     |
|  <p>22.0 cm<br/>10.4 cm<br/>6.0 cm</p> <p><b>CARBÓN ACTIVADO</b><br/>100% NATURAL</p> <p>LARGO: 22.0 cm / ANCHO: 10.4 cm / ALTO: 6.0 cm</p> | <p><b>CHEVROLET</b></p> <p>APLICACIÓN</p> <p>VENTURE 2001-2005 6C 3.4L /</p>  | <p><b>JAC5248CA</b></p> <p>EQUIVALENCIA</p> <table border="1"> <tr><td>8327</td><td>FRAM</td></tr> <tr><td>CFI-5248CA</td><td>INTERFIL</td></tr> <tr><td>24811</td><td>WIX</td></tr> </table>  | 8327    | FRAM | CFI-5248CA | INTERFIL | 24811 | WIX |
| 8327   | FRAM  |  |         |      |            |          |       |     |
| CFI-5248CA   | INTERFIL  |  |         |      |            |          |       |     |
| 24811  | WIX   |  |         |      |            |          |       |     |
|  <p>21.7 cm<br/>24.8 cm</p> <p>LARGO: 24.8 cm / ANCHO: 21.7 cm / ALTO: 2.3 cm</p>   | <p><b>CHEVROLET</b></p> <p>APLICACIÓN</p> <p>COBALT 2005-2010 4C 2.0L / COBALT 2005-2010 4C 2.2L / COBALT 2006-2008 4C 2.4L / HHR 2006-2008 4C 2.0L / HHR 2006-2011 4C 2.2L / HHR 2006-2011 4C 2.4L /</p> | <p><b>JAC5249</b></p> <p>EQUIVALENCIA</p> <table border="1"> <tr><td>CF10361</td><td>FRAM</td></tr> <tr><td>CFI-5249</td><td>INTERFIL</td></tr> <tr><td>24811</td><td>WIX</td></tr> </table>   | CF10361 | FRAM | CFI-5249   | INTERFIL | 24811 | WIX |
| CF10361  | FRAM  |  |         |      |            |          |       |     |
| CFI-5249   | INTERFIL  |  |         |      |            |          |       |     |
| 24811  | WIX   |  |         |      |            |          |       |     |
|  <p>1.8 cm<br/>11.3 cm<br/>22.7 CM</p> <p><b>CARBÓN ACTIVADO</b><br/>100% NATURAL</p> <p>LARGO: 22.7 cm / ANCHO: 11.3 cm / ALTO: 1.8 cm</p> | <p><b>CHEVROLET</b></p> <p>APLICACIÓN</p> <p>TRACKER 1999-2002 4C 1.6L / TRACKER 1999-2003 4C 2.0L / TRACKER 2001-2004 6C 2.5L /</p>  | <p><b>JAC8726CA</b></p> <p>EQUIVALENCIA</p> <table border="1"> <tr><td>CF8726A</td><td>FRAM</td></tr> <tr><td>CFI-8726</td><td>INTERFIL</td></tr> <tr><td>24899</td><td>WIX</td></tr> </table> | CF8726A | FRAM | CFI-8726   | INTERFIL | 24899 | WIX |
| CF8726A  | FRAM  |  |         |      |            |          |       |     |
| CFI-8726   | INTERFIL  |  |         |      |            |          |       |     |
| 24899  | WIX   |  |         |      |            |          |       |     |





| CHEVROLET  |  | JAC8898      |                 |
|--|--|--------------|-----------------|
| APLICACIÓN   |  | EQUIVALENCIA |                 |
| AVALANCHE MOD. 2003-2006 8 CIL. 5.3 LTS. /<br>SILVERADO 1500 PICKUP MOD. 2003-2004 6 CIL. 4.3<br>LTS. / SILVERADO 1500 PICKUP MOD. 2003-2004 8 CIL.<br>4.8 LTS. / SILVERADO 2500 MOD. 2003-2004 8 CIL. 6.0<br>LTS. |  | CF10360      | <b>FRAM</b>     |
|  |  | CFI-8898     | <b>INTERFIL</b> |
|  |  | 24814        | <b>WIX</b>      |

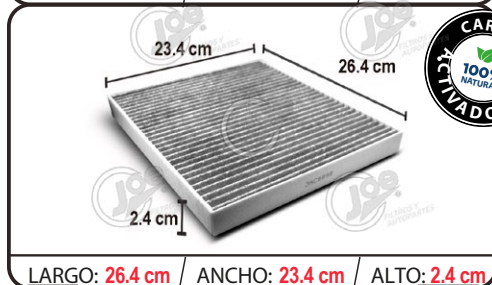

| CHEVROLET  |  | JAC8898CA    |                 |
|--|--|--------------|-----------------|
| APLICACIÓN   |  | EQUIVALENCIA |                 |
| AVALANCHE MOD. 2003-2006 8 CIL. 5.3 LTS. /<br>SILVERADO 1500 PICKUP MOD. 2003-2004 6 CIL. 4.3<br>LTS. / SILVERADO 1500 PICKUP MOD. 2003-2004 8 CIL.<br>4.8 LTS. / SILVERADO 2500 MOD. 2003-2004 8 CIL. 6.0<br>LTS. |  | CF10360      | <b>FRAM</b>     |
|  |  | CFI-8898     | <b>INTERFIL</b> |
|  |  | 24814        | <b>WIX</b>      |

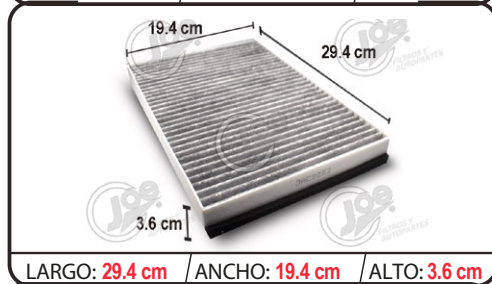

| CHEVROLET   |  | JAC9052      |                 |
|---|--|--------------|-----------------|
| APLICACIÓN  |  | EQUIVALENCIA |                 |
| ASTRA 2006 4C 2.0L / ASTRA 2003-2004 4C 2.2L / ASTRA<br>STATION WAGON 2003-2004 4C 2.2L / ZAFIRA 2002-2005<br>4C 1.8L / ZAFIRA 2002 4C 2.2L / |  | N/D          | <b>FRAM</b>     |
|   |  | CFI-9052     | <b>INTERFIL</b> |
|   |  | 49364        | <b>WIX</b>      |



| CHEVROLET   |  | JAC9052CA    |                 |
|---|--|--------------|-----------------|
| APLICACIÓN  |  | EQUIVALENCIA |                 |
| ASTRA 2004-2006, 2.2 LTS. 4 CIL. / 2.0 LTS. TURBO 4 CIL.<br>ASTRA STATION WAG 2003-2004 / 1.8 LTS. 4 CIL. /<br>ZAFIRA 2002-2005 / 2.2 LTS. 4 CIL. / 1.8 LTS. 4 CIL. |  | CU3054       | <b>FRAM</b>     |
|   |  | C25837       | <b>INTERFIL</b> |
|   |  | 49364        | <b>WIX</b>      |



| CHEVROLET  |  | JAC9318      |                 |
|--|--|--------------|-----------------|
| APLICACIÓN   |  | EQUIVALENCIA |                 |
| ASTRA 2001-20074C 1.8L / ASTRA 2003-2004 4C 2.2L /<br>ASTRA 2004 4C 2.4L / ASTRA WAGON 2004 4C 2.2L /<br>CHEVY C2 2007 4C 1.6L / |  | N/D          | <b>FRAM</b>     |
|  |  | CFI-9318     | <b>INTERFIL</b> |
|  |  | WP6800       | <b>WIX</b>      |

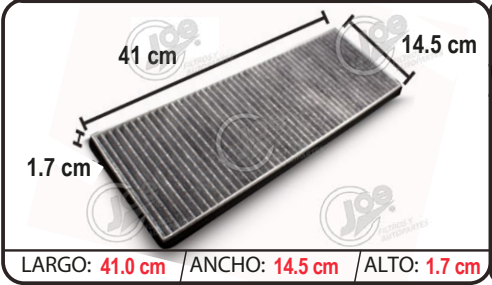

| CHEVROLET  |  | JAC9318CA    |                 |
|--|--|--------------|-----------------|
| APLICACIÓN   |  | EQUIVALENCIA |                 |
| ASTRA 2001-20074C 1.8L / ASTRA 2003-2004 4C 2.2L /<br>ASTRA 2004 4C 2.4L / ASTRA WAGON 2004 4C 2.2L /<br>CHEVY C2 2007 4C 1.6L / |  | N/D          | <b>FRAM</b>     |
|  |  | CFI-9318CA   | <b>INTERFIL</b> |
|  |  | WP6800       | <b>WIX</b>      |



| CHEVROLET                 | JAC9538      |          |
|---------------------------|--------------|----------|
| APLICACIÓN                | EQUIVALENCIA |          |
| SPARK 2013-2015 4C 1.2L / | N/D          | FRAM     |
|                           | CFI-9538     | INTERFIL |
|                           | WP2020       | WIX      |



| CHEVROLET                 | JAC9538CA    |          |
|---------------------------|--------------|----------|
| APLICACIÓN                | EQUIVALENCIA |          |
| SPARK 2013-2015 4C 1.2L / | N/D          | FRAM     |
|                           | CFI-9538CA   | INTERFIL |
|                           | WP2020       | WIX      |



| CHEVROLET                 | JAC9629CA    |          |
|---------------------------|--------------|----------|
| APLICACIÓN                | EQUIVALENCIA |          |
| EPICA 2004-2008 6C 2.5L / | N/D          | FRAM     |
|                           | CFI-9629     | INTERFIL |
|                           | 24906        | WIX      |

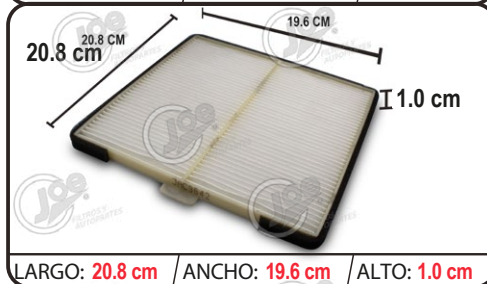

| CHEVROLET                  | JAC9642      |          |
|----------------------------|--------------|----------|
| APLICACIÓN                 | EQUIVALENCIA |          |
| MATIZ 2003- 2015 4C 1.0L / | N/D          | FRAM     |
|                            | CFI-9642     | INTERFIL |
|                            |              | WIX      |



| CHEVROLET                 | JAC9655      |          |
|---------------------------|--------------|----------|
| APLICACIÓN                | EQUIVALENCIA |          |
| OPTRA 2007-2010 4C 2.0L / | CF10557      | FRAM     |
|                           | CFI-9655     | INTERFIL |
|                           | 24902        | WIX      |



| CHEVROLET                 | JAC9655CA    |          |
|---------------------------|--------------|----------|
| APLICACIÓN                | EQUIVALENCIA |          |
| OPTRA 2007-2010 4C 2.0L / | CF10557      | FRAM     |
|                           | CFI-9655     | INTERFIL |
|                           | 24902        | WIX      |

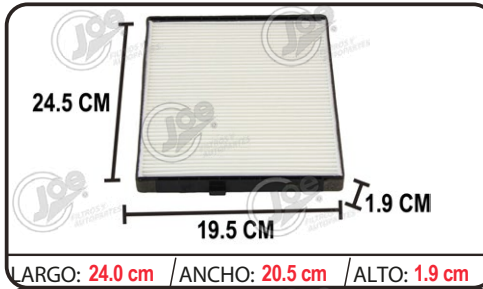

| CHEVROLET                | JAC9696                  |
|--------------------------|--------------------------|
| APLICACIÓN               | EQUIVALENCIA             |
| AVEO 2004-2011 4C 1.6L / | CF10546 <b>FRAM</b>      |
|                          | CFI-9696 <b>INTERFIL</b> |
|                          | 24685 <b>WIX</b>         |

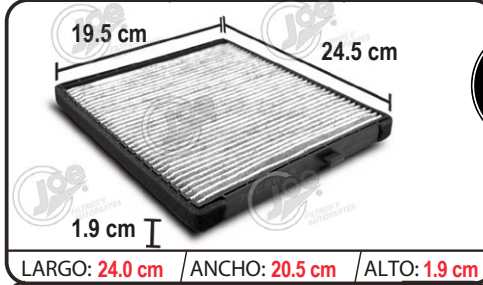

| CHEVROLET                | JAC9696CA                |
|--------------------------|--------------------------|
| APLICACIÓN               | EQUIVALENCIA             |
| AVEO 2004-2011 4C 1.6L / | CF10546 <b>FRAM</b>      |
|                          | CFI-9696 <b>INTERFIL</b> |
|                          | 24685 <b>WIX</b>         |



| CHEVROLET                | JAC9812                  |
|--------------------------|--------------------------|
| APLICACIÓN               | EQUIVALENCIA             |
| AVEO 2012-2017 4C 1.6L / | N/D <b>FRAM</b>          |
|                          | CFI-9812 <b>INTERFIL</b> |
|                          | 10168 <b>WIX</b>         |

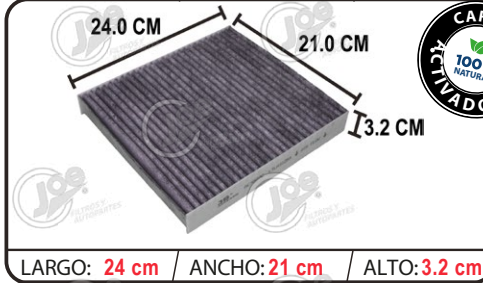

| CHEVROLET                             | JAC9904CA           |
|---------------------------------------|---------------------|
| APLICACIÓN                            | EQUIVALENCIA        |
| MERIVA 4 CIL. 1.8 LTS. MOD. 2003-2010 | N/D <b>FRAM</b>     |
|                                       | N/D <b>INTERFIL</b> |
|                                       | N/D <b>WIX</b>      |

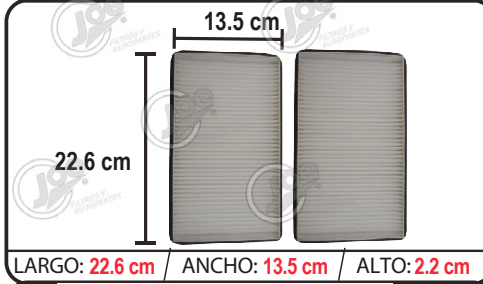

| CHEVROLET   | JAC9910                  |
|---|--------------------------|
| APLICACIÓN  | EQUIVALENCIA             |
| 2500 2000-2002 8C 4.8L / 2500 2000-2002 8C 5.3L / 2500 2000-2002 8C 6.0L / 2500 2000-2002 8C 8.1L / 2500 FLEX FUEL 2002 8C 5.3L / AVALANCHE 2002 8C 5.3L / AVALANCHE 2002 8C 8.1L / AVALANCHE 1500-2500 2002 8C 5.3L / 1500-2500 2002 8C 8.1L / SILVERADO 1500 1999-2002 8C 5.3L / SILVERADO 1500 2001-2002 8C 6.0L / SILVERADO 1500 PICKUP 1999-2002 6C 4.3L / SILVERADO 1500 PICKUP 1999-2002 6C 4.8L / SILVERADO 1500 PICKUP 2002 8C 5.3L / SILVERADO 1500 PICKUP 2001-2002 8C 8.1L / SILVERADO 2500 1999-2002 8C 5.3L / SILVERADO 2500 2001-2002 8C 6.0L / SILVERADO 2500 PICKUP 2001-2002 8C 8.1L / SILVERADO 3500 PICKUP 2001-2002 8C 8.1L / SUBURBAN 2000-2002 8C 5.3L / SUBURBAN 2001-2002 8C 5.7L / TAHOE 2001-2002 8C 5.3L / TAHOE 2000 8C 5.7L / | CF8791 <b>FRAM</b>       |
|   | CFI-9910 <b>INTERFIL</b> |
|   | 24805 <b>WIX</b>         |

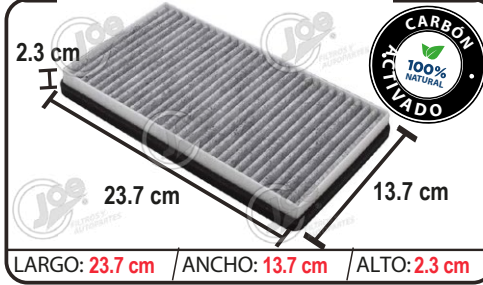

| CHEVROLET   | JAC9910CA                |
|---|--------------------------|
| APLICACIÓN  | EQUIVALENCIA             |
| 2500 2000-2002 8C 4.8L / 2500 2000-2002 8C 5.3L / 2500 2000-2002 8C 6.0L / 2500 2000-2002 8C 8.1L / 2500 FLEX FUEL 2002 8C 5.3L / AVALANCHE 2002 8C 5.3L / AVALANCHE 2002 8C 8.1L / AVALANCHE 1500-2500 2002 8C 5.3L / 1500-2500 2002 8C 8.1L / SILVERADO 1500 1999-2002 8C 5.3L / SILVERADO 1500 2001-2002 8C 6.0L / SILVERADO 1500 PICKUP 1999-2002 6C 4.3L / SILVERADO 1500 PICKUP 1999-2002 6C 4.8L / SILVERADO 1500 PICKUP 2002 8C 5.3L / SILVERADO 1500 PICKUP 2001-2002 8C 8.1L / SILVERADO 2500 1999-2002 8C 5.3L / SILVERADO 2500 2001-2002 8C 6.0L / SILVERADO 2500 PICKUP 2001-2002 8C 8.1L / SILVERADO 3500 PICKUP 2001-2002 8C 8.1L / SUBURBAN 2000-2002 8C 5.3L / SUBURBAN 2001-2002 8C 5.7L / TAHOE 2001-2002 8C 5.3L / TAHOE 2000 8C 5.7L / | CF8791 <b>FRAM</b>       |
|   | CFI-9910 <b>INTERFIL</b> |
|   | 24805 <b>WIX</b>         |



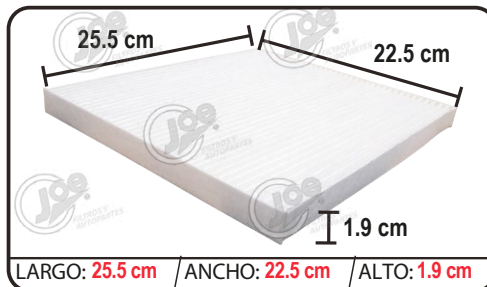

| CHEVROLET   |  | JAC10742     |                 |
|---|--|--------------|-----------------|
| APLICACIÓN  |  | EQUIVALENCIA |                 |
| CAPTIVA 2012-2015 6C 3.0L / EQUINOX 2010-2017 4 CIL |  | CF10742      | <b>FRAM</b>     |
|   |  | CF10742      | <b>INTERFIL</b> |
|   |  | 49368        | <b>WIX</b>      |

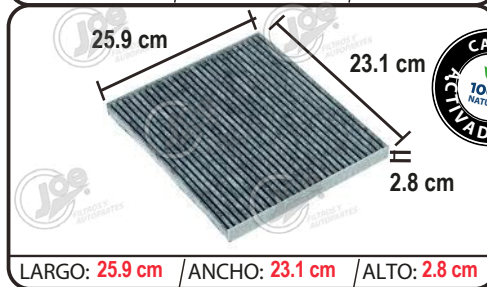

| CHEVROLET   |  | JAC10742CA   |                 |
|---|--|--------------|-----------------|
| APLICACIÓN  |  | EQUIVALENCIA |                 |
| CAPTIVA 2012-2015 6C 3.0L / EQUINOX 2010-2017 4 CIL |  | CF10742      | <b>FRAM</b>     |
|   |  | CF10742      | <b>INTERFIL</b> |
|   |  | 49368        | <b>WIX</b>      |



| CHEVROLET             |  | JAC11176     |                 |
|-----------------------|--|--------------|-----------------|
| APLICACIÓN            |  | EQUIVALENCIA |                 |
| AVEO 1.5 L. 2018-2020 |  | N/A          | <b>FRAM</b>     |
|                       |  | N/A          | <b>INTERFIL</b> |
|                       |  | N/A          | <b>WIX</b>      |



| CHEVROLET             |  | JAC11176CA   |                 |
|-----------------------|--|--------------|-----------------|
| APLICACIÓN            |  | EQUIVALENCIA |                 |
| AVEO 1.5 L. 2018-2020 |  | N/A          | <b>FRAM</b>     |
|                       |  | N/A          | <b>INTERFIL</b> |
|                       |  | N/A          | <b>WIX</b>      |

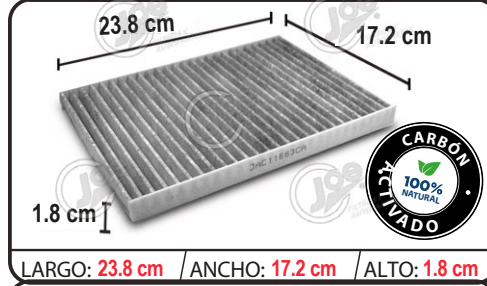

| CHEVROLET   |  | JAC11663CA   |                 |
|---|--|--------------|-----------------|
| APLICACIÓN  |  | EQUIVALENCIA |                 |
| TRAVERSE 2009-2001 6C 3.6L / TRAVERSE 2012-2017 6 CIL. 3.6L / |  | CF11663      | <b>FRAM</b>     |
|   |  | CFI-11663    | <b>INTERFIL</b> |
|   |  | WP10074      | <b>WIX</b>      |



| CHRYSLER                      |  | JAC2028      |                 |
|-------------------------------|--|--------------|-----------------|
| APLICACIÓN                    |  | EQUIVALENCIA |                 |
| CROSSFIRE 2004-2008 4C 2.4L / |  | CF5842       | <b>FRAM</b>     |
|                               |  | CFI-2028     | <b>INTERFIL</b> |
|                               |  | 22767        | <b>WIX</b>      |

|  |  |  |         |      |            |          |         |     |
|--|--|--|---------|------|------------|----------|---------|-----|
|  <p>25.5 cm<br/>20.5 cm<br/>5.4 cm</p> <p>LARGO: 25.5 cm / ANCHO: 20.5 cm / ALTO: 5.4 cm</p>   | <p><b>CHRYSLER</b></p> <p>APLICACIÓN</p> <p>CROSSFIRE 2004-2008 4C 2.4L /</p>  | <p><b>JAC2028CA</b></p> <p>EQUIVALENCIA</p> <table border="1"> <tr><td>CF5842</td><td>FRAM</td></tr> <tr><td>CFI-2028</td><td>INTERFIL</td></tr> <tr><td>22767</td><td>WIX</td></tr> </table>    | CF5842  | FRAM | CFI-2028   | INTERFIL | 22767   | WIX |
| CF5842   | FRAM   |  |         |      |            |          |         |     |
| CFI-2028   | INTERFIL   |  |         |      |            |          |         |     |
| 22767  | WIX  |  |         |      |            |          |         |     |
|  <p>21.7 CM<br/>19.2 CM<br/>2.5 CM</p> <p>LARGO: 21.7 cm / ANCHO: 19.2 cm / ALTO: 2.5 cm</p>   | <p><b>CHRYSLER</b></p> <p>APLICACIÓN</p> <p>200 2011-2014 4C 2.4L / 2002011-2014 6C 3.6L / CIRRUS 2007 4C 2.4L / SEBRING 2007-2010 4C 2.4L / SEBRING 2007-2010 6C 3.5L /</p>   | <p><b>JAC5058</b></p> <p>EQUIVALENCIA</p> <table border="1"> <tr><td>CF10729</td><td>FRAM</td></tr> <tr><td>CFI-5058</td><td>INTERFIL</td></tr> <tr><td>24313</td><td>WIX</td></tr> </table>     | CF10729 | FRAM | CFI-5058   | INTERFIL | 24313   | WIX |
| CF10729  | FRAM   |  |         |      |            |          |         |     |
| CFI-5058   | INTERFIL   |  |         |      |            |          |         |     |
| 24313  | WIX  |  |         |      |            |          |         |     |
|  <p>21.7 cm<br/>19.2 cm<br/>2.5 cm</p> <p>LARGO: 21.7 cm / ANCHO: 19.2 cm / ALTO: 2.5 cm</p>  | <p><b>CHRYSLER</b></p> <p>APLICACIÓN</p> <p>200 2011-2014 4C 2.4L / 2002011-2014 6C 3.6L / CIRRUS 2007 4C 2.4L / SEBRING 2007-2010 4C 2.4L / SEBRING 2007-2010 6C 3.5L /</p>   | <p><b>JAC5058CA</b></p> <p>EQUIVALENCIA</p> <table border="1"> <tr><td>CF10729</td><td>FRAM</td></tr> <tr><td>CFI-5058CA</td><td>INTERFIL</td></tr> <tr><td>24313</td><td>WIX</td></tr> </table> | CF10729 | FRAM | CFI-5058CA | INTERFIL | 24313   | WIX |
| CF10729  | FRAM   |  |         |      |            |          |         |     |
| CFI-5058CA   | INTERFIL   |  |         |      |            |          |         |     |
| 24313  | WIX  |  |         |      |            |          |         |     |
|  <p>22.8 cm<br/>31 cm<br/>2.5 cm</p> <p>LARGO: 31.0 cm / ANCHO: 22.8 cm / ALTO: 2.5 cm</p>   | <p><b>CHRYSLER</b></p> <p>APLICACIÓN</p> <p>GRAND VOYAGER 2001-2003 4C 2.4L / GRAND VOYAGER 2001-2003 6C 3.3L / PACIFICA 2004-2006 6C 3.5L / PACIFICA 2005-2008 6C 3.8L / PACIFICA 2007-2008 6C 4.0L / TOWN &amp; COUNTRY LX LIMITED 2001-2007 6C 3.3L / TOWN &amp; COUNTRY LX LIMITED 2001-2007 6C 3.8L / VOYAGER 2001-2006 6C 3.3L /</p> | <p><b>JAC8220</b></p> <p>EQUIVALENCIA</p> <table border="1"> <tr><td>CF9597A</td><td>FRAM</td></tr> <tr><td>CFI-8220</td><td>INTERFIL</td></tr> <tr><td>N/D</td><td>WIX</td></tr> </table>       | CF9597A | FRAM | CFI-8220   | INTERFIL | N/D     | WIX |
| CF9597A  | FRAM   |  |         |      |            |          |         |     |
| CFI-8220   | INTERFIL   |  |         |      |            |          |         |     |
| N/D  | WIX  |  |         |      |            |          |         |     |
|  <p>31.0 cm<br/>2.5 cm<br/>23.6 cm</p> <p>LARGO: 31.0 cm / ANCHO: 23.6 cm / ALTO: 2.5 cm</p> | <p><b>CHRYSLER</b></p> <p>APLICACIÓN</p> <p>GRAND VOYAGER 2001-2003 4C 2.4L / GRAND VOYAGER 2001-2003 6C 3.3L / PACIFICA 2004-2006 6C 3.5L / PACIFICA 2005-2008 6C 3.8L / PACIFICA 2007-2008 6C 4.0L / TOWN &amp; COUNTRY LX LIMITED 2001-2007 6C 3.3L / TOWN &amp; COUNTRY LX LIMITED 2001-2007 6C 3.8L / VOYAGER 2001-2006 6C 3.3L /</p> | <p><b>JAC8220CA</b></p> <p>EQUIVALENCIA</p> <table border="1"> <tr><td>CF9597A</td><td>FRAM</td></tr> <tr><td>CFI-8220</td><td>INTERFIL</td></tr> <tr><td>N/D</td><td>WIX</td></tr> </table>     | CF9597A | FRAM | CFI-8220   | INTERFIL | N/D     | WIX |
| CF9597A  | FRAM   |  |         |      |            |          |         |     |
| CFI-8220   | INTERFIL   |  |         |      |            |          |         |     |
| N/D  | WIX  |  |         |      |            |          |         |     |
|  <p>24 cm<br/>21.8 cm<br/>2 cm</p> <p>LARGO: 21.8 cm / ANCHO: 24 cm / ALTO: 2 cm</p>         | <p><b>CHRYSLER</b></p> <p>APLICACIÓN</p> <p>200 2015-2017 4C 2.4L / 200 2015-2017 6C 3.6L /</p>  | <p><b>JAC10142CA</b></p> <p>EQUIVALENCIA</p> <table border="1"> <tr><td>N/D</td><td>FRAM</td></tr> <tr><td>CFI-10142</td><td>INTERFIL</td></tr> <tr><td>WP10142</td><td>WIX</td></tr> </table>   | N/D     | FRAM | CFI-10142  | INTERFIL | WP10142 | WIX |
| N/D  | FRAM   |  |         |      |            |          |         |     |
| CFI-10142  | INTERFIL   |  |         |      |            |          |         |     |
| WP10142  | WIX  |  |         |      |            |          |         |     |

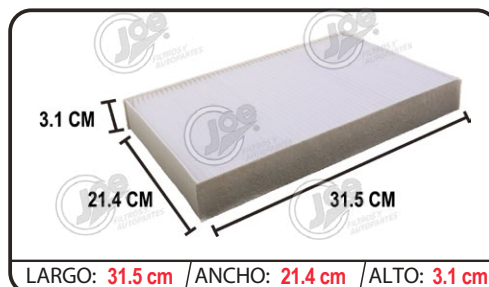

| CHRYSLER  |  | JAC10364     |          |
|---|--|--------------|----------|
| APLICACIÓN  |  | EQUIVALENCIA |          |
| 300 2005-2010 6C 2.7L / 300 6C 3.5L / 300 2005-2010 6C 5.7L / 300 2005-2010 6C 6.1L / |  | N/D          | FRAM     |
|   |  | CFI-10364    | INTERFIL |
|   |  | WP24909      | WIX      |

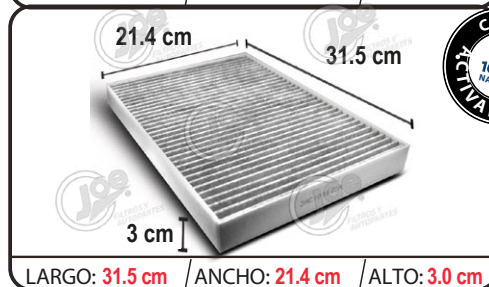

| CHRYSLER  |  | JAC10364CA   |          |
|---|--|--------------|----------|
| APLICACIÓN  |  | EQUIVALENCIA |          |
| 300 2005-2010 6C 2.7L / 300 6C 3.5L / 300 2005-2010 6C 5.7L / 300 2005-2010 6C 6.1L / |  | N/D          | FRAM     |
|   |  | CFI-10364CA  | INTERFIL |
|   |  | WP24909      | WIX      |

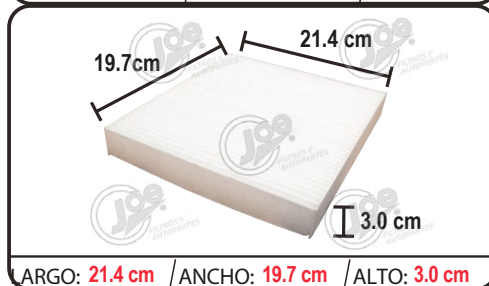

| CHRYSLER   |  | JAC10743     |          |
|--|--|--------------|----------|
| APLICACIÓN   |  | EQUIVALENCIA |          |
| PACIFICA 2017 6C 3.6L / TOWN & COUNTRY 2008-2010 6C 3.3L / TOWN & COUNTRY 2011-2016 6C 3.6L / TOWN & COUNTRY 2008-2010 6C 3.8L / |  | CF10743      | FRAM     |
|  |  | CF10743      | INTERFIL |
|  |  | 24479        | WIX      |

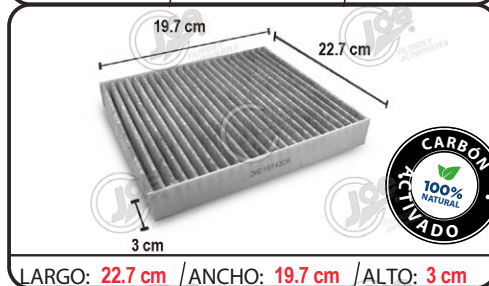

| CHRYSLER   |  | JAC10743CA   |          |
|--|--|--------------|----------|
| APLICACIÓN   |  | EQUIVALENCIA |          |
| PACIFICA 2017 6C 3.6L / TOWN & COUNTRY 2008-2010 6C 3.3L / TOWN & COUNTRY 2011-2016 6C 3.6L / TOWN & COUNTRY 2008-2010 6C 3.8L / |  | CF10743      | FRAM     |
|  |  | CF10743      | INTERFIL |
|  |  | 24479        | WIX      |

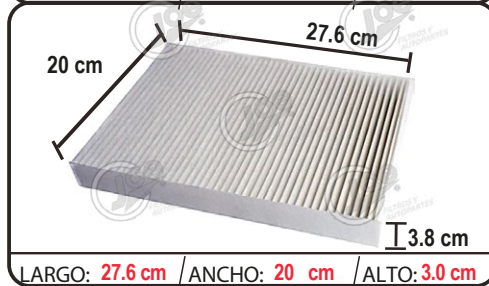

| CHRYSLER  |  | JAC11668     |          |
|---|--|--------------|----------|
| APLICACIÓN                                      |  | EQUIVALENCIA |          |
| 300 2011-2019 6C 3.6L / 300 2011-2019 8C 5.7C / |  | CF11668      | FRAM     |
|   |  | CFI-11668    | INTERFIL |
|   |  | 24048        | WIX      |

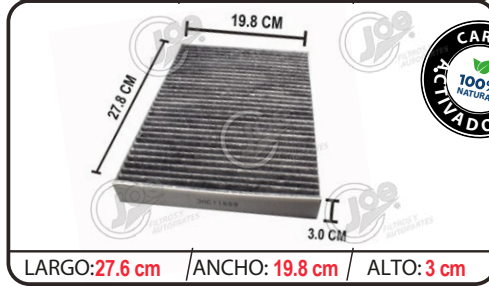

| CHRYSLER  |  | JAC11668CA   |          |
|---|--|--------------|----------|
| APLICACIÓN                                      |  | EQUIVALENCIA |          |
| 300 2011-2019 6C 3.6L / 300 2011-2019 8C 5.7C / |  | CF11668      | FRAM     |
|   |  | CFI-11668    | INTERFIL |
|   |  | 24048        | WIX      |

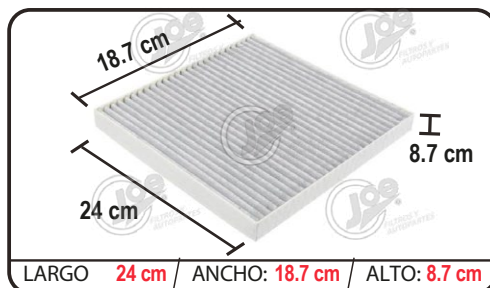

| DODGE                                     |  | JAC0211            |          |
|---|--|--------------------|----------|
| APLICACIÓN                                |  | EQUIVALENCIA       |          |
| DODGE DART 1.4 L. 2.0 L. 2.4 L. 2013-2016 |  | CF10374            | FRAM     |
|   |  | CFI-0211           | INTERFIL |
|   |  | UNIFIL<br>FC-10374 | WIX      |

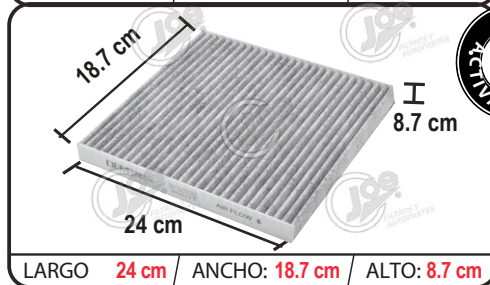

| DODGE                                     |  | JAC0211CA          |          |
|---|--|--------------------|----------|
| APLICACIÓN                                |  | EQUIVALENCIA       |          |
| DODGE DART 1.4 L. 2.0 L. 2.4 L. 2013-2016 |  | CF10374            | FRAM     |
|   |  | CFI-0211           | INTERFIL |
|   |  | UNIFIL<br>FC-10374 | WIX      |

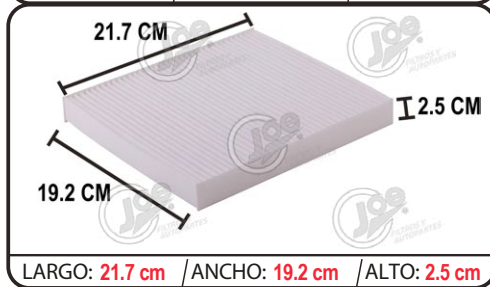

| DODGE   |  | JAC5058      |          |
|---|--|--------------|----------|
| APLICACIÓN  |  | EQUIVALENCIA |          |
| AVENGER 2007-2008 4C 2.0L / AVENGER 2008-2014 4C 2.4L / AVENGER 2008-2010 6C 2.7L / AVENGER 2008-2014 6C 3.5L / CALIVER 2007-2009 4C 1.8L / CALIVER 2007-2011 4C 2.0L / CALIVER 2008-2009 4C 2.4L TURBO / JOURNEY 2009-2019 4C 2.4L / JOURNEY 2009-2019 6C 3.5L / JOURNEY 2011-2015 6C 3.6L / |  | CF10729      | FRAM     |
|   |  | CFI-5058     | INTERFIL |
|   |  | 24313        | WIX      |

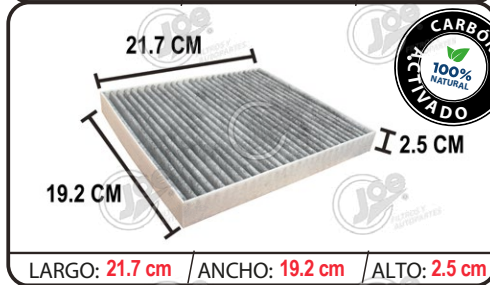

| DODGE   |  | JAC5058CA    |          |
|---|--|--------------|----------|
| APLICACIÓN  |  | EQUIVALENCIA |          |
| AVENGER 2007-2008 4C 2.0L / AVENGER 2008-2014 4C 2.4L / AVENGER 2008-2010 6C 2.7L / AVENGER 2008-2014 6C 3.5L / CALIVER 2007-2009 4C 1.8L / CALIVER 2007-2011 4C 2.0L / CALIVER 2008-2009 4C 2.4L TURBO / JOURNEY 2009-2019 4C 2.4L / JOURNEY 2009-2019 6C 3.5L / JOURNEY 2011-2015 6C 3.6L / |  | CF10729      | FRAM     |
|   |  | CFI-5058CA   | INTERFIL |
|   |  | 24313        | WIX      |



| DODGE  |  | JAC7082      |          |
|--|--|--------------|----------|
| APLICACIÓN   |  | EQUIVALENCIA |          |
| ALBEA 2005-2008 4C 1.4L / ALBEA 2005-2008 4C 1.6L / RAM 700 2015-2018 4C 1.6L / VISION 2015-2018 4C 1.6L / |  |              | FRAM     |
|  |  | CFI-7082     | INTERFIL |
|  |  | WP9280       | WIX      |

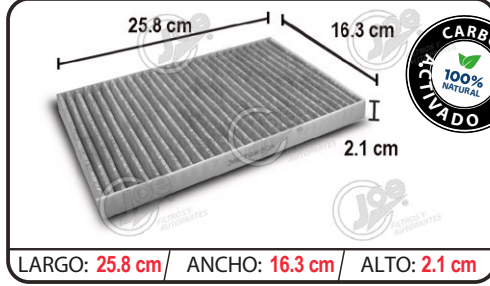

| DODGE  |  | JAC7082CA    |          |
|--|--|--------------|----------|
| APLICACIÓN   |  | EQUIVALENCIA |          |
| ALBEA 2005-2008 4C 1.4L / ALBEA 2005-2008 4C 1.6L / RAM 700 2015-2018 4C 1.6L / VISION 2015-2018 4C 1.6L / |  |              | FRAM     |
|  |  | CFI-7082     | INTERFIL |
|  |  | WP9280       | WIX      |



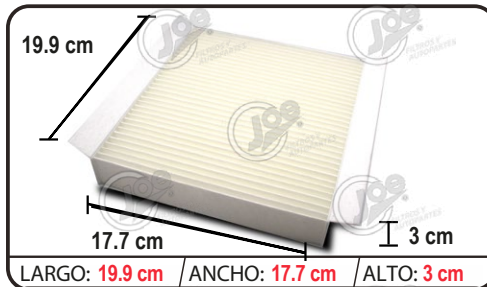

**DODGE**

**JAC7736**

APLICACIÓN

EQUIVALENCIA

NEON 4 CIL. 1.6 LTS. MOD. 2017-2018 / DODEG RAM  
PROMASTER CITY 4 CIL. 2.4 LTS. MOD. 2018

CFI-7736

**FRAM**

**INTERFIL**

**WIX**

LARGO: 19.9 cm / ANCHO: 17.7 cm / ALTO: 3 cm

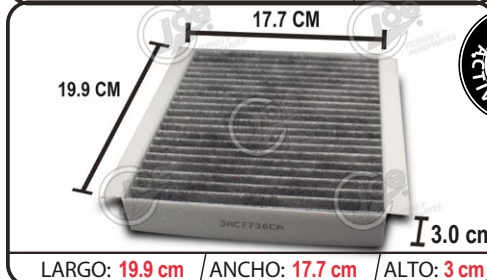

**DODGE**

**JAC7736CA**

APLICACIÓN

EQUIVALENCIA

NEON 4 CIL. 1.6 LTS. MOD. 2017-2018 / DODEG RAM  
PROMASTER CITY 4 CIL. 2.4 LTS. MOD. 2018

CFI-7736

**FRAM**

**INTERFIL**

**WIX**

LARGO: 19.9 cm / ANCHO: 17.7 cm / ALTO: 3 cm

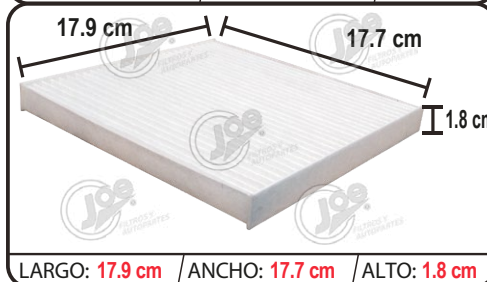

**DODGE**

**JAC7850**

APLICACIÓN

EQUIVALENCIA

ATTITUDE 2015-2018 4C 1.2L /

N/D

**FRAM**

CFI-7850

**INTERFIL**

**WIX**

LARGO: 17.9 cm / ANCHO: 17.7 cm / ALTO: 1.8 cm

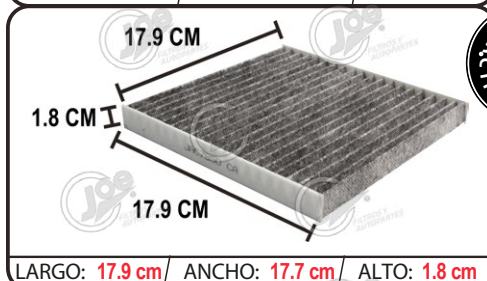

**DODGE**

**JAC7850CA**

APLICACIÓN

EQUIVALENCIA

ATTITUDE 2015-2018 4C 1.2L /

N/D

**FRAM**

CFI-7850

**INTERFIL**

**WIX**

LARGO: 17.9 cm / ANCHO: 17.7 cm / ALTO: 1.8 cm



**DODGE**

**JAC8220**

APLICACIÓN

EQUIVALENCIA

CARAVAN 2001-2007 4C 2.4L / CARAVAN 2001-2007 6C  
3.3L / CARAVAN 2001-2007 6C 3.8L / GRAND CARAVAN  
2001-2007 4C 2.4L / GRAND CARAVAN 2001-2007 6C 3.3L  
/ GRAND CARAVAN 2001-2007 6C 3.8L /

CF9597A

**FRAM**

CFI-8220

**INTERFIL**

**WIX**

LARGO: 31.0 cm / ANCHO: 22.8 cm / ALTO: 2.5 cm

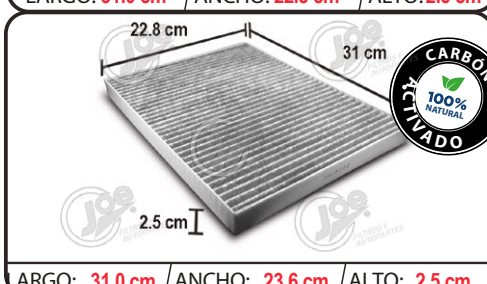

**DODGE**

**JAC8220CA**

APLICACIÓN

EQUIVALENCIA

CARAVAN 2001-2007 4C 2.4L / CARAVAN 2001-2007 6C  
3.3L / CARAVAN 2001-2007 6C 3.8L / GRAND CARAVAN  
2001-2007 4C 2.4L / GRAND CARAVAN 2001-2007 6C 3.3L  
/ GRAND CARAVAN 2001-2007 6C 3.8L /

CF9597A

**FRAM**

CFI-8220

**INTERFIL**

**WIX**

LARGO: 31.0 cm / ANCHO: 23.6 cm / ALTO: 2.5 cm



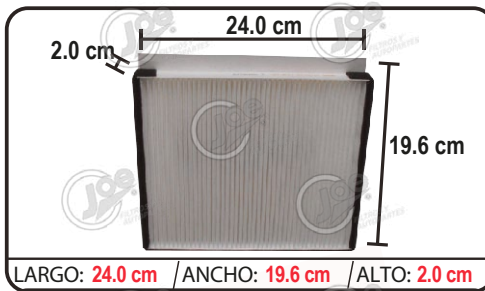

| DODGE                        |  | JAC9713      |          |
|------------------------------|--|--------------|----------|
| APLICACIÓN                   |  | EQUIVALENCIA |          |
| ATTITUDE 2005-2010 4C 1.6L / |  | CF10719      | FRAM     |
|                              |  | CFI-9713     | INTERFIL |
|                              |  | 24484        | WIX      |

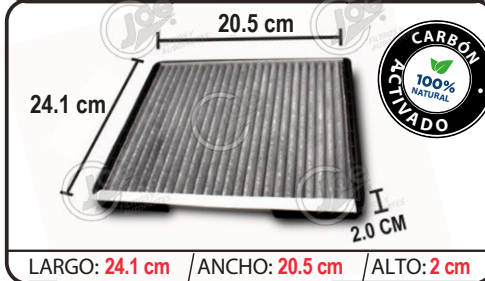

| DODGE                        |  | JAC9713CA    |          |
|------------------------------|--|--------------|----------|
| APLICACIÓN                   |  | EQUIVALENCIA |          |
| ATTITUDE 2005-2010 4C 1.6L / |  | CF10719      | FRAM     |
|                              |  | CFI-9713     | INTERFIL |
|                              |  |              | WIX      |

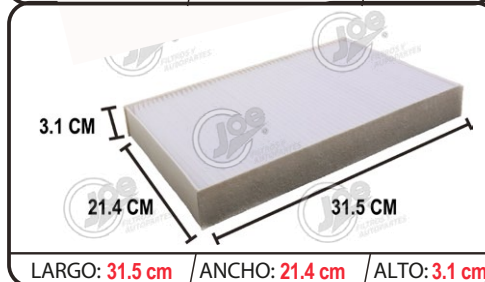

| DODGE  |  | JAC10364     |          |
|--|--|--------------|----------|
| APLICACIÓN   |  | EQUIVALENCIA |          |
| CHARGER 2006-2010 6C 2.7L / CHARGER 2006-2010 6C 3.5L /<br>CHARGER 2006-2010 6C 5.7L / CHARGER 2006-2010 6C 6.1L /<br>MAGNUM 2005-2008 6C 2.7L / MAGNUM 2005-2008 6C 3.5L /<br>MAGNUM 2005-2008 6C 5.7L / MAGNUM 2006-2008 6C 6.1L / |  | N/D          | FRAM     |
|  |  | CFI-10364    | INTERFIL |
|  |  | WP24909      | WIX      |

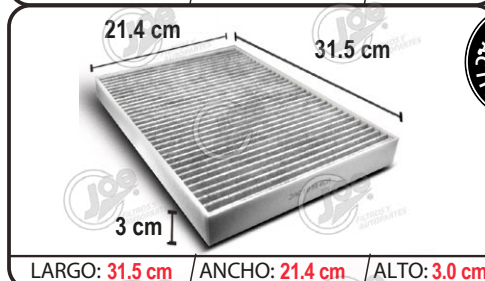

| DODGE  |  | JAC10364CA   |          |
|--|--|--------------|----------|
| APLICACIÓN   |  | EQUIVALENCIA |          |
| CHARGER 2006-2010 6C 2.7L / CHARGER 2006-2010 6C 3.5L /<br>CHARGER 2006-2010 6C 5.7L / CHARGER 2006-2010 6C 6.1L /<br>MAGNUM 2005-2008 6C 2.7L / MAGNUM 2005-2008 6C 3.5L /<br>MAGNUM 2005-2008 6C 5.7L / MAGNUM 2006-2008 6C 6.1L / |  | N/D          | FRAM     |
|  |  | CFI-10364CA  | INTERFIL |
|  |  | WP24909      | WIX      |



| DODGE                    |  | JAC10627     |          |
|--------------------------|--|--------------|----------|
| APLICACIÓN               |  | EQUIVALENCIA |          |
| I-10 2007-2014 4C 1.1L / |  | CF10627      | FRAM     |
|                          |  | CFI-10627    | INTERFIL |
|                          |  | WP9344       | WIX      |

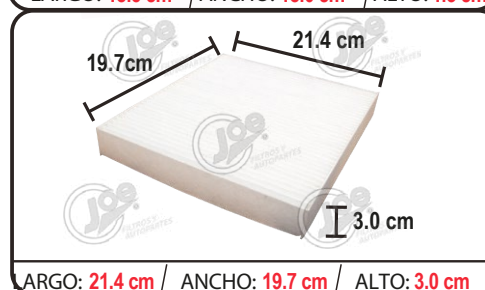

| DODGE   |  | JAC10743     |          |
|---|--|--------------|----------|
| APLICACIÓN  |  | EQUIVALENCIA |          |
| GRAND CARAVAN 2008-2019 6C 3.6L / GRAND<br>CARAVAN 2008-2010 6C 3.8L / GRAND CARAVAN<br>2008-2010 6C 4.0L / |  | CF10743      | FRAM     |
|   |  | CF10743      | INTERFIL |
|   |  | 24479        | WIX      |



| DODGE   |  | JAC10743CA   |                 |
|---|--|--------------|-----------------|
| APLICACIÓN  |  | EQUIVALENCIA |                 |
| GRAND CARAVAN 2008-2019 6C 3.6L / GRAND CARAVAN 2008-2010 6C 3.8L / GRAND CARAVAN 2008-2010 6C 4.0L / |  | CF10743      | <b>FRAM</b>     |
|   |  | CF10743      | <b>INTERFIL</b> |
|   |  | 24479        | <b>WIX</b>      |

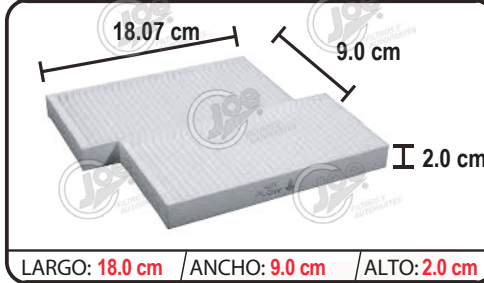

| DODGE   |  | JAC10747     |                 |
|---|--|--------------|-----------------|
| APLICACIÓN  |  | EQUIVALENCIA |                 |
| NITRO 2007-2011 6C 3.7L / NITRO 2007-2011 6C 4.0L / |  | CF10747      | <b>FRAM</b>     |
|   |  | CF10747      | <b>INTERFIL</b> |
|   |  | 49093        | <b>WIX</b>      |

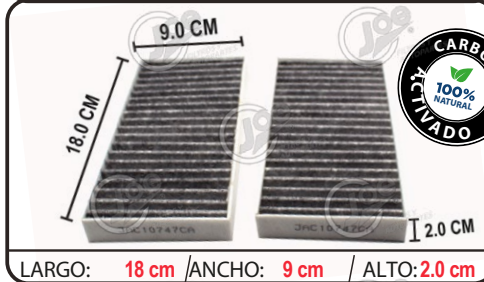

| DODGE   |  | JAC10747CA   |                 |
|---|--|--------------|-----------------|
| APLICACIÓN  |  | EQUIVALENCIA |                 |
| NITRO 2007-2011 6C 3.7L / NITRO 2007-2011 6C 4.0L / |  | CF10747      | <b>FRAM</b>     |
|   |  | CF10747      | <b>INTERFIL</b> |
|   |  | 49093        | <b>WIX</b>      |



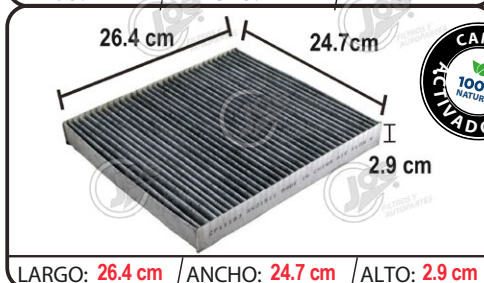

| DODGE   |  | JAC11183     |                 |
|---|--|--------------|-----------------|
| APLICACIÓN  |  | EQUIVALENCIA |                 |
| DURANGO 2011-2016 6C 3.6L / DURANGO 2011-2019 8C 5.7L / |  | CF11183      | <b>FRAM</b>     |
|   |  | CFI-11183    | <b>INTERFIL</b> |
|   |  | 24017        | <b>WIX</b>      |



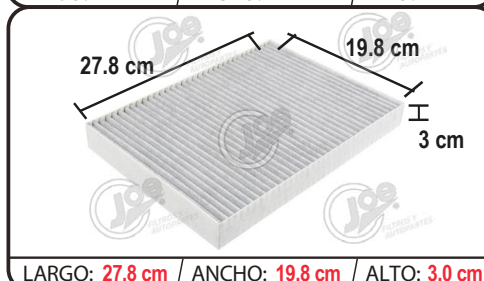



| DODGE   |  | JAC11183CA   |                 |
|---|--|--------------|-----------------|
| APLICACIÓN  |  | EQUIVALENCIA |                 |
| DURANGO 2011-2016 6C 3.6L / DURANGO 2011-2019 8C 5.7L / |  | CF11183      | <b>FRAM</b>     |
|   |  | CFI-11183    | <b>INTERFIL</b> |
|   |  | 24017        | <b>WIX</b>      |



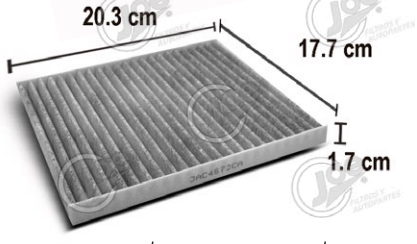

| DODGE  |  | JAC11668     |                 |
|--|--|--------------|-----------------|
| APLICACIÓN   |  | EQUIVALENCIA |                 |
| CHALLENGER 2011-2019 6C 3.6L / CHALLENGER 2011-2019 8C 6.2L / CHALLENGER 2011-2019 8C 6.4L / CHARGER 2011-2019 8C 5.7L / CHARGER 2011-2019 8C 6.4L / |  | CF11668      | <b>FRAM</b>     |
|  |  | CFI-11668    | <b>INTERFIL</b> |
|  |  | 24048        | <b>WIX</b>      |

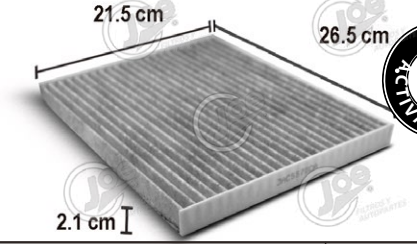
|  |   |  |  |                   |          |
|--|---|--|--|-------------------|----------|
|  <p>27.8 cm<br/>19.8 cm<br/>3.0 cm</p> <p>LARGO: 27.8 cm / ANCHO: 19.8 cm / ALTO: 3 cm</p> |  | <b>DODGE</b>   |  | <b>JAC11668CA</b> |          |
|  |   | APLICACIÓN   |  | EQUIVALENCIA      |          |
|  |   | CHALLENGER 2011-2019 6C 3.6L / CHALLENGER 2011-2019 8C 6.2L / CHALLENGER 2011-2019 8C 6.4L / CHARGER 2011-2019 8C 5.7L / CHARGER 2011-2019 8C 6.4L / |  | CF11668           | FRAM     |
|  |   |  |  | CFI-11668         | INTERFIL |
|  |   |  |  | 24048             | WIX      |

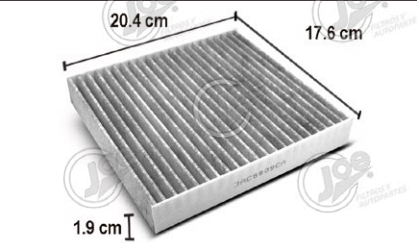

|  |   |   |  |                  |          |
|--|---|---|--|------------------|----------|
|  <p>20.3 cm<br/>17.7 cm<br/>1.7 cm</p> <p>LARGO: 20.3 cm / ANCHO: 17.7 cm / ALTO: 1.7 cm</p> |  | <b>FIAT</b>   |  | <b>JAC4672CA</b> |          |
|  |   | APLICACIÓN  |  | EQUIVALENCIA     |          |
|  |   | 500 2007-2010 4C 1.4L / NUOVA 500 2007-2010 4C 1.4L / PANDA 2003-2010 4C 1.2L / PANDA 2006-2010 4C 1.4L / |  | N/D              | FRAM     |
|  |   |   |  | CFI-4672         | INTERFIL |
|  |   |   |  | WP9210           | WIX      |

|   |   |                           |  |                  |          |
|---|---|---------------------------|--|------------------|----------|
|  <p>21.5 cm<br/>26.5 cm<br/>2.1 cm</p> <p>LARGO: 26.5 cm / ANCHO: 21.5 cm / ALTO: 2.1 cm</p> |  | <b>FIAT</b>               |  | <b>JAC5570CA</b> |          |
|   |   | APLICACIÓN                |  | EQUIVALENCIA     |          |
|   |   | PUNTO 2007-2008 4C 1.4L / |  | N/D              | FRAM     |
|   |   |                           |  | CFI-5570         | INTERFIL |
|   |   |                           |  | WP9250           | WIX      |

|  |  |   |  |                |          |
|--|--|---|--|----------------|----------|
|  <p>3.0 cm<br/>19.1 cm<br/>18.5 cm</p> <p>LARGO: 19.1 cm / ANCHO: 18.5 cm / ALTO: 3 cm</p> |  | <b>FIAT</b>   |  | <b>JAC6809</b> |          |
|  |  | APLICACIÓN  |  | EQUIVALENCIA   |          |
|  |  | 500 2012-2016 4C 1.4L / 500 2013-2015 ELECTRICO / UNO 2015-2016 4C 1.4L / |  | CF11924        | FRAM     |
|  |  |   |  | CFI-6809       | INTERFIL |
|  |  |   |  | 24053          | WIX      |

|  |   |   |  |                  |          |
|--|---|---|--|------------------|----------|
|  <p>20.4 cm<br/>17.6 cm<br/>1.9 cm</p> <p>LARGO: 20.4 cm / ANCHO: 17.6 cm / ALTO: 1.9 cm</p> |  | <b>FIAT</b>   |  | <b>JAC6809CA</b> |          |
|  |   | APLICACIÓN  |  | EQUIVALENCIA     |          |
|  |   | 500 2012-2016 4C 1.4L / 500 2013-2015 ELECTRICO / UNO 2015-2016 4C 1.4L / |  | CF11924          | FRAM     |
|  |   |   |  | CFI-6809         | INTERFIL |
|  |   |   |  | 24053            | WIX      |

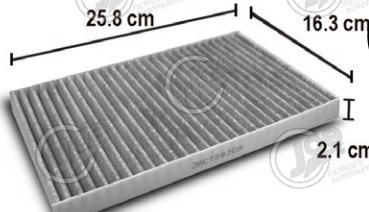
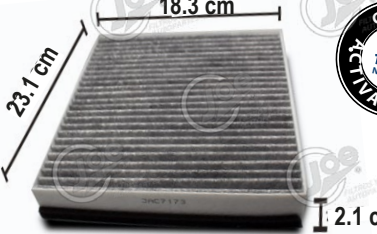
|  |  |  |  |                |          |
|--|--|--|--|----------------|----------|
|  <p>25.8 cm<br/>16.3 cm<br/>2.1 cm</p> <p>LARGO: 25.8 cm / ANCHO: 16.3 cm / ALTO: 2.1 cm</p> |  | <b>FIAT</b>  |  | <b>JAC7082</b> |          |
|  |  | APLICACIÓN   |  | EQUIVALENCIA   |          |
|  |  | PALIO ADVENTURE 2015-2016 4C 1.6L / STRADA 1999-2006 4C 1.2L / STRADA 2006-2010 4C 1.3L / STRADA 1999-2002 4C 1.7L / STRADA 1999-2006 4C 1.9L / STRADA ADVENTURE 2006-2007 4C 1.8L / |  | N/D            | FRAM     |
|  |  |  |  | CFI-7082       | INTERFIL |
|  |  |  |  | WP9280         | WIX      |

|   |  |   |         |      |          |          |                |     |
|---|--|---|---------|------|----------|----------|----------------|-----|
|  <p>LARGO: 25.8 cm / ANCHO: 16.3 cm / ALTO: 2.1 cm</p>   | <p><b>FIAT</b></p> <p>APLICACIÓN</p> <p>PALIO ADVENTURE 2015-2016 4C 1.6L / STRADA 1999-2006 4C 1.2L / STRADA 2006-2010 4C 1.3L / STRADA 1999-2002 4C 1.7L / STRADA 1999-2006 4C 1.9L / STRADA ADVENTURE 2006-2007 4C 1.8L /</p> | <p><b>JAC7082CA</b></p> <p>EQUIVALENCIA</p> <table border="1"> <tr><td>N/D</td><td>FRAM</td></tr> <tr><td>CFI-7082</td><td>INTERFIL</td></tr> <tr><td>WP9280</td><td>WIX</td></tr> </table>           | N/D     | FRAM | CFI-7082 | INTERFIL | WP9280         | WIX |
| N/D   | FRAM   |   |         |      |          |          |                |     |
| CFI-7082  | INTERFIL   |   |         |      |          |          |                |     |
| WP9280  | WIX  |   |         |      |          |          |                |     |
|  <p>LARGO: 23.1 cm / ANCHO: 18.3 cm / ALTO: 2.1 cm</p>   | <p><b>FIAT</b></p> <p>APLICACIÓN</p> <p>STILO 2007-2008 4C 1.4L /</p>  | <p><b>JAC7173CA</b></p> <p>EQUIVALENCIA</p> <table border="1"> <tr><td>N/D</td><td>FRAM</td></tr> <tr><td>CFI-7173</td><td>INTERFIL</td></tr> <tr><td>WP9117</td><td>WIX</td></tr> </table>           | N/D     | FRAM | CFI-7173 | INTERFIL | WP9117         | WIX |
| N/D   | FRAM   |   |         |      |          |          |                |     |
| CFI-7173  | INTERFIL   |   |         |      |          |          |                |     |
| WP9117  | WIX  |   |         |      |          |          |                |     |
|  <p>LARGO: 19.9 cm / ANCHO: 17.7 cm / ALTO: 3 cm</p>    | <p><b>FIAT</b></p> <p>APLICACIÓN</p> <p>FIAT DOBLO 2002-2010</p>   | <p><b>JAC7736</b></p> <p>EQUIVALENCIA</p> <table border="1"> <tr><td></td><td>FRAM</td></tr> <tr><td>CFI-7736</td><td>INTERFIL</td></tr> <tr><td></td><td>WIX</td></tr> </table>                      |         | FRAM | CFI-7736 | INTERFIL |                | WIX |
|   | FRAM   |   |         |      |          |          |                |     |
| CFI-7736  | INTERFIL   |   |         |      |          |          |                |     |
|   | WIX  |   |         |      |          |          |                |     |
|  <p>LARGO: 19.9 cm / ANCHO: 17.7 cm / ALTO: 3 cm</p>    | <p><b>FIAT</b></p> <p>APLICACIÓN</p> <p>FIAT DOBLO 2002-2010</p>   | <p><b>JAC7736CA</b></p> <p>EQUIVALENCIA</p> <table border="1"> <tr><td></td><td>FRAM</td></tr> <tr><td>CFI-7736</td><td>INTERFIL</td></tr> <tr><td></td><td>WIX</td></tr> </table>                    |         | FRAM | CFI-7736 | INTERFIL |                | WIX |
|   | FRAM   |   |         |      |          |          |                |     |
| CFI-7736  | INTERFIL   |   |         |      |          |          |                |     |
|   | WIX  |   |         |      |          |          |                |     |
|  <p>LARGO: 23.5 cm / ANCHO: 21.0 cm / ALTO: 3.4 cm</p> | <p><b>FORD</b></p> <p>APLICACIÓN</p> <p>FOCUS 2007 4C 2.0L / RANGER 2015-2017 4C 2.2L TURBO DIESEL / RANGER 2015-2016 4C 2.5L /</p>  | <p><b>JAC1354</b></p> <p>EQUIVALENCIA</p> <table border="1"> <tr><td>CF10375</td><td>FRAM</td></tr> <tr><td>CFI-1354</td><td>INTERFIL</td></tr> <tr><td>49354 / WP2094</td><td>WIX</td></tr> </table> | CF10375 | FRAM | CFI-1354 | INTERFIL | 49354 / WP2094 | WIX |
| CF10375   | FRAM   |   |         |      |          |          |                |     |
| CFI-1354  | INTERFIL   |   |         |      |          |          |                |     |
| 49354 / WP2094  | WIX  |   |         |      |          |          |                |     |
|  <p>LARGO: 23.5 cm / ANCHO: 20.9 cm / ALTO: 3.4 cm</p> | <p><b>FORD</b></p> <p>APLICACIÓN</p> <p>FOCUS 2007 4C 2.0L / RANGER 2015-2017 4C 2.2L TURBO DIESEL / RANGER 2015-2016 4C 2.5L /</p>  | <p><b>JAC1354CA</b></p> <p>EQUIVALENCIA</p> <table border="1"> <tr><td>CF10375</td><td>FRAM</td></tr> <tr><td>CFI-1354</td><td>INTERFIL</td></tr> <tr><td>WP2094</td><td>WIX</td></tr> </table>       | CF10375 | FRAM | CFI-1354 | INTERFIL | WP2094         | WIX |
| CF10375   | FRAM   |   |         |      |          |          |                |     |
| CFI-1354  | INTERFIL   |   |         |      |          |          |                |     |
| WP2094  | WIX  |   |         |      |          |          |                |     |

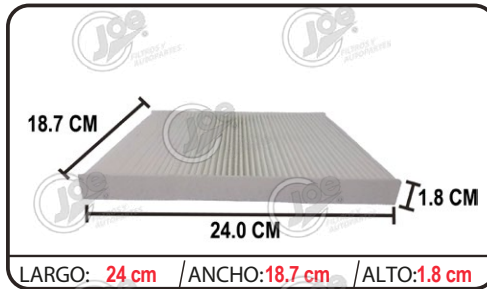

| FORD   |  | JAC1811      |          |
|--|--|--------------|----------|
| APLICACIÓN   |  | EQUIVALENCIA |          |
| FIESTA 2012-2015 4C 1.6L / FIESTA 2014-2015 4C 1.6 TURBO / |  | N/D          | FRAM     |
|  |  | CFI-1811     | INTERFIL |
|  |  | WP9360       | WIX      |

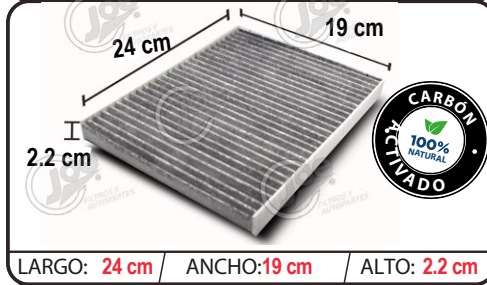

| FORD   |  | JAC1811CA    |          |
|--|--|--------------|----------|
| APLICACIÓN   |  | EQUIVALENCIA |          |
| FIESTA 2012-2015 4C 1.6L / FIESTA 2014-2015 4C 1.6 TURBO / |  | N/D          | FRAM     |
|  |  | CFI-1811     | INTERFIL |
|  |  | WP9360       | WIX      |

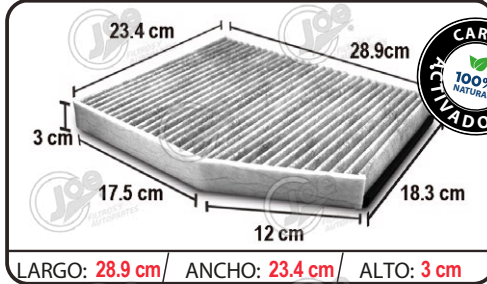

| FORD                                 |  | JAC1812CA    |          |
|--------------------------------------|--|--------------|----------|
| APLICACIÓN                           |  | EQUIVALENCIA |          |
| FORD TRANSIT 2012-2016 4C 2.2L TDI / |  | N/D          | FRAM     |
|                                      |  | CFI-1812     | INTERFIL |
|                                      |  | N/D          | WIX      |

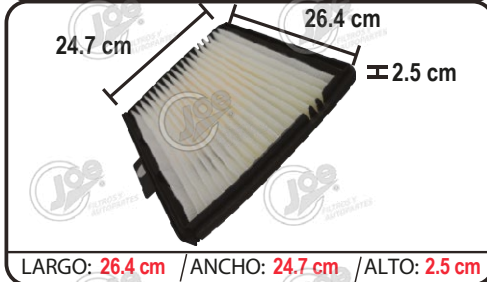

| FORD  |  | JAC19N6      |          |
|---|--|--------------|----------|
| APLICACIÓN  |  | EQUIVALENCIA |          |
| EXPEDITION 2002-2003 6C 4.0L / EXPEDITION 1997-2003 8C 4.6L / EXPEDITION 1997-2003 8C 5.4L / F-150 1999-2003 10C 6.8L / F-150 1997-2003 8C 4.2L / F-150 1997-2003 8C 4.6L / F-150 2003 8C 6.0L TURBO DIESEL / F-150 1997-2003 8C 7.3L TURBO DIESEL / F-150 1997 8C 7.5L / F-350 1997-2002 10C 6.8L / F-350 1997-2003 8C 4.2L / F-350 1999-2002 8C 7.3L TURBO DIESEL / F-450 SUPER DUTY 1999-2004 10C 6.8L / F-450 SUPER DUTY 2003 8C 3.6L TURBO DIESEL / F-450 SUPER DUTY 2001-2002 8C 5.4L / F-450 SUPER DUTY 1997-2003 8C 7.3L TURBO DIESEL / F-550 SUPER DUTY 1999-2004 10C 6.8L / F-550 SUPER DUTY 2001-2002 8C 5.4L / F-550 SUPER DUTY 2003 8C 6.0L TURBO DIESEL / F-550 SUPER DUTY 1999-2003 8C 7.3L TURBO DIESEL / |  | CF8631       | FRAM     |
|   |  | CFI-19N6     | INTERFIL |
|   |  | 24876        | WIX      |



| FORD  |  | JAC2S6H      |          |
|---|--|--------------|----------|
| APLICACIÓN  |  | EQUIVALENCIA |          |
| ECOSPORT 2005-2008 4C 2.0L / ECOSPORT AUTOMATICA 2008 4C 2.0L / FIESTA 2009 4C 1.6L / FIESTA SEDAN 2005-2008 4C 1.6L / FIESTA HATCHBACK 2003-2007 4C 1.6L / |  | CF9666       | FRAM     |
|   |  | CFI-2S6H     | INTERFIL |
|   |  | WP9110       | WIX      |

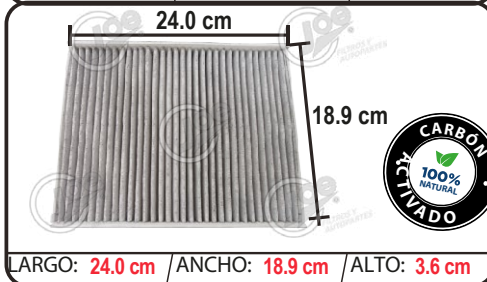

| FORD  |  | JAC2S6HCA    |          |
|---|--|--------------|----------|
| APLICACIÓN  |  | EQUIVALENCIA |          |
| ECOSPORT 2005-2008 4C 2.0L / ECOSPORT AUTOMATICA 2008 4C 2.0L / FIESTA 2009 4C 1.6L / FIESTA SEDAN 2005-2008 4C 1.6L / FIESTA HATCHBACK 2003-2007 4C 1.6L / |  | CF9666       | FRAM     |
|   |  | CFI-2S6HCA   | INTERFIL |
|   |  | WP9110       | WIX      |

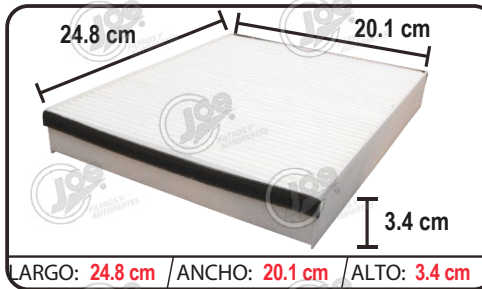

| FORD   |  | JAC6Z19      |          |
|--|--|--------------|----------|
| APLICACIÓN   |  | EQUIVALENCIA |          |
| ESCAPE 2012-2019 4C 1.6L / ESCAPE 2012-2019 4C 2.5L / FOCUS 2012-2016 4C 2.0L / FOCUS ST 2012-2016 4C 2.0L TURBO / TRANSIT CONNECT 2012-2015 4C 1.6L / TRANSIT CONNECT 2012-2015 4C 2.5L / |  | CF920        | FRAM     |
|  |  | CFI-6Z19     | INTERFIL |
|  |  | 24419        | WIX      |

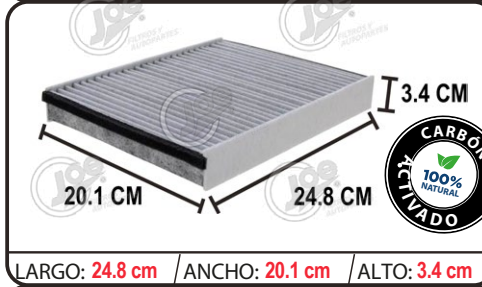

| FORD   |  | JAC6Z19CA    |          |
|--|--|--------------|----------|
| APLICACIÓN   |  | EQUIVALENCIA |          |
| ESCAPE 2012-2019 4C 1.6L / ESCAPE 2012-2019 4C 2.5L / FOCUS 2012-2016 4C 2.0L / FOCUS ST 2012-2016 4C 2.0L TURBO / TRANSIT CONNECT 2012-2015 4C 1.6L / TRANSIT CONNECT 2012-2015 4C 2.5L / |  | CF920        | FRAM     |
|  |  | CFI-6Z19     | INTERFIL |
|  |  | 24419        | WIX      |

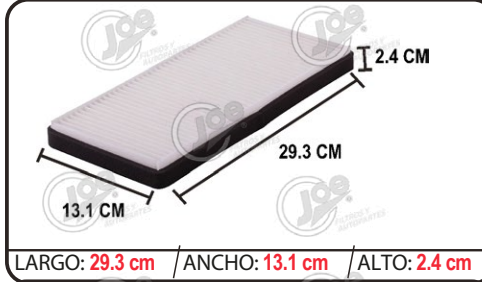

| FORD   |  | JACXF2Z      |          |
|--|--|--------------|----------|
| APLICACIÓN   |  | EQUIVALENCIA |          |
| FREESTAR 2007 6C 2.0L / FREESTAR 2004-2007 6C 3.9L / FREESTAR 2004-2007 6C 4.2L / FREESTYLE 2005-2007 6C3.0L / WINDSTAR 1999-2000 6C 3.0L / WINDSTAR 1999-2003 6C 3.8L / |  | CF8921       | FRAM     |
|  |  | CFI-XF2Z     | INTERFIL |
|  |  | 24807        | WIX      |

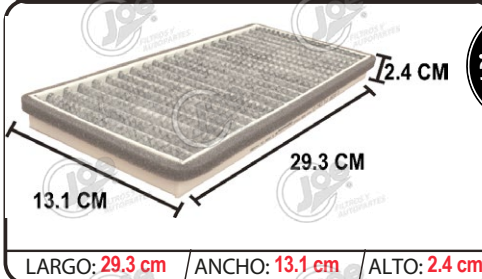

| FORD   |  | JACXF2ZCA    |          |
|--|--|--------------|----------|
| APLICACIÓN   |  | EQUIVALENCIA |          |
| FREESTAR 2007 6C 2.0L / FREESTAR 2004-2007 6C 3.9L / FREESTAR 2004-2007 6C 4.2L / FREESTYLE 2005-2007 6C3.0L / WINDSTAR 1999-2000 6C 3.0L / WINDSTAR 1999-2003 6C 3.8L / |  | CF8921       | FRAM     |
|  |  | CFI-XF2Z     | INTERFIL |
|  |  | 24807        | WIX      |



| FORD   |  | JAC8L8Z      |          |
|--|--|--------------|----------|
| APLICACIÓN   |  | EQUIVALENCIA |          |
| ESCAPE 2013 4C 2.0 TURBO / ESCAPE 2007-2008 4C 2.3L / ESCAPE 2009-2012 4C 2.5L / ESCAPE 2007-2012 4C 3.0L / ESCAPE HIBRIDO 2007 4C 2.3L / ESCAPE HIBRIDO 2008-2012 4C 2.5L / |  | CF10548      | FRAM     |
|  |  | CFI-8L8Z     | INTERFIL |
|  |  | 49466        | WIX      |



| FORD   |  | JAC8Z19      |          |
|--|--|--------------|----------|
| APLICACIÓN   |  | EQUIVALENCIA |          |
| ECOSPORT 2018 4C 1.5L / ECOSPORT 2016-2018 4C 2.0L / FIGO 2016-2018 4C 1.5L / FIESTA 2011-2019 4C 1.6L / |  | CF11670      | FRAM     |
|  |  | CFI-8Z19     | INTERFIL |
|  |  | 24619        | WIX      |



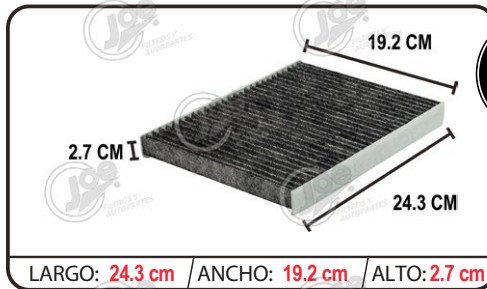

LARGO: 24.3 cm / ANCHO: 19.2 cm / ALTO: 2.7 cm



**FORD**

APLICACIÓN

ECOSPORT 2018 4C 1.5L / ECOSPORT 2016-2018 4C 2.0L / FIGO 2016-2018 4C 1.5L / FIESTA 2011-2019 4C 1.6L /

**JAC8Z19CA**

EQUIVALENCIA

|            |                 |
|------------|-----------------|
| CF11670    | <b>FRAM</b>     |
| CFI-8Z19CA | <b>INTERFIL</b> |
| 24619      | <b>WIX</b>      |



LARGO: 52.0 cm / ANCHO: 10.8 cm / ALTO: 3.0 cm



**FORD**

APLICACIÓN

MONDEO 2001-2007 4C 2.0L / MONDEO 2001-2007 6C 2.5L / MONDEO 2005-2007 6C 3.0L /

**JAC93BWCA**

EQUIVALENCIA

|            |                 |
|------------|-----------------|
| CF8046     | <b>FRAM</b>     |
| CFI-93BWCA | <b>INTERFIL</b> |
| 24771      | <b>WIX</b>      |



LARGO: 27.8 cm / ANCHO: 22.5 cm / ALTO: 2.0 cm

**FORD**

APLICACIÓN

ECOSPORT 2018 4C 1.5L / ECOSPORT 2016-2018 4C 2.0L / FIGO 2016-2018 4C 1.5L / FIESTA 2011-2019 4C 1.6L /

**JAC9Z19**

EQUIVALENCIA

|          |                 |
|----------|-----------------|
| CF11775  | <b>FRAM</b>     |
| CFI-9Z19 | <b>INTERFIL</b> |
| WP10084  | <b>WIX</b>      |

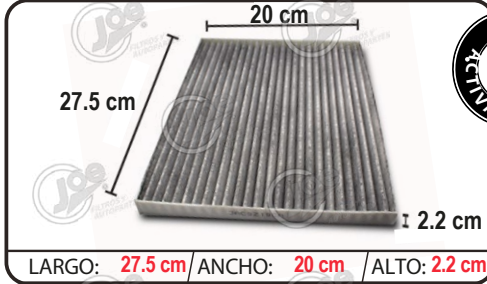

LARGO: 27.5 cm / ANCHO: 20 cm / ALTO: 2.2 cm



**FORD**

APLICACIÓN

ECOSPORT 2018 4C 1.5L / ECOSPORT 2016-2018 4C 2.0L / FIGO 2016-2018 4C 1.5L / FIESTA 2011-2019 4C 1.6L /

**JAC9Z19CA**

EQUIVALENCIA

|          |                 |
|----------|-----------------|
| CF11775  | <b>FRAM</b>     |
| CFI-9Z19 | <b>INTERFIL</b> |
| WP10084  | <b>WIX</b>      |

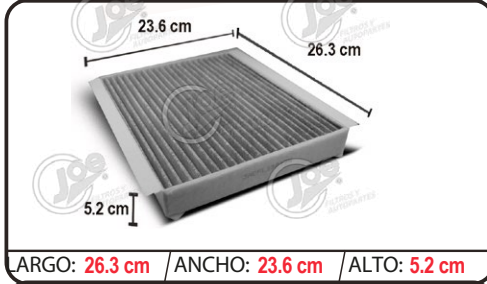

LARGO: 26.3 cm / ANCHO: 23.6 cm / ALTO: 5.2 cm

**FORD**

APLICACIÓN

F150 TURBOCARGADO 2018 V6 3.5L. / F150 2018 V8 5.0L / F150 2018 V6 2.7L / F150 2018 V6 3.3L / F250 SUPER DUTY V8 6.7L / F350 SUPER DUTY 2018 V8 6.2, 6.7L TAURUS 1996-2004 6C 3.0L / TAURUS 1996-1999 6C 3.4L /

**JACFL33Z19N**

EQUIVALENCIA

|     |                 |
|-----|-----------------|
| N/D | <b>FRAM</b>     |
| N/D | <b>INTERFIL</b> |
| N/D | <b>WIX</b>      |

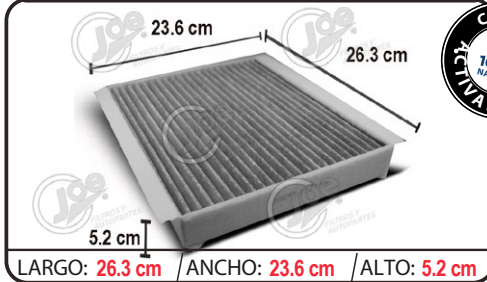

LARGO: 26.3 cm / ANCHO: 23.6 cm / ALTO: 5.2 cm



**FORD**

APLICACIÓN

F150 TURBOCARGADO 2018 V6 3.5L. / F150 2018 V8 5.0L / F150 2018 V6 2.7L / F150 2018 V6 3.3L / F250 SUPER DUTY V8 6.7L / F350 SUPER DUTY 2018 V8 6.2, 6.7L TAURUS 1996-2004 6C 3.0L / TAURUS 1996-1999 6C 3.4L /

**JACFL33Z19NCA**

EQUIVALENCIA

|     |                 |
|-----|-----------------|
| N/D | <b>FRAM</b>     |
| N/D | <b>INTERFIL</b> |
| N/D | <b>WIX</b>      |

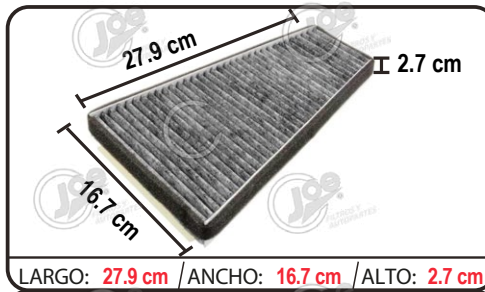

| FORD  |  | JACF6DZ      |          |
|---|--|--------------|----------|
| APLICACIÓN  |  | EQUIVALENCIA |          |
| TAURUS 1996-2004 6C 3.0L / TAURUS 1996-1999 6C 3.4L / |  | CF8109A      | FRAM     |
|   |  | CFI-F6DZ     | INTERFIL |
|   |  | 24773        | WIX      |

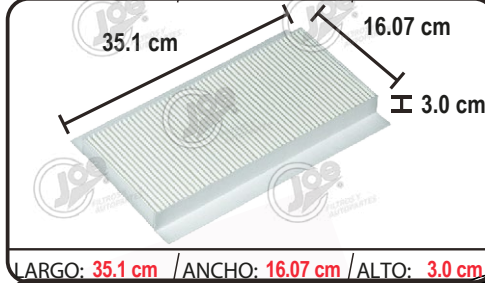

| FORD   |  | JACXS4H      |          |
|--|--|--------------|----------|
| APLICACIÓN   |  | EQUIVALENCIA |          |
| ESCORT 2000-2002 4C 2.0L / FOCUS 2000-2011 4C 2.0L / FOCUS SVT 2002-2004 4C 2.0L / FOCUS 2000-2003 4C 2.0L / TRANSIT CONNECT 2010-2013 4C 2.0L / |  | CF9118       | FRAM     |
|  |  | CFI-XS4H     | INTERFIL |
|  |  | 24808        | WIX      |

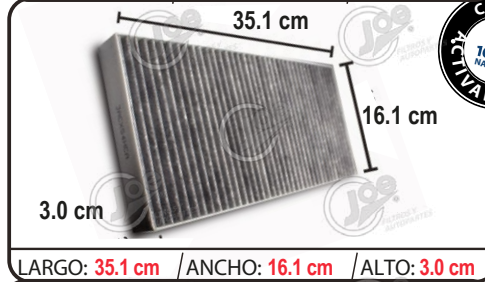

| FORD   |  | JACXS4HCA    |          |
|--|--|--------------|----------|
| APLICACIÓN   |  | EQUIVALENCIA |          |
| ESCORT 2000-2002 4C 2.0L / FOCUS 2000-2011 4C 2.0L / FOCUS SVT 2002-2004 4C 2.0L / FOCUS 2000-2003 4C 2.0L / TRANSIT CONNECT 2010-2013 4C 2.0L / |  | CF9118       | FRAM     |
|  |  | CFI-XS4HCA   | INTERFIL |
|  |  | 24808        | WIX      |



| FORD  |  | JACYL84      |          |
|---|--|--------------|----------|
| APLICACIÓN  |  | EQUIVALENCIA |          |
| ESCAPE 2013 4C 1.6L TURBO / ESCAPE 2001-2013 4C 2.0L / ESCAPE 2005-2006 4C 2.3L / ESCAPE 2001-2012 6C 3.0L / ESCAPE HIBRIDO 2005-2006 4C 2.3L / ESCAPE XLS 2001-2004 6C 2.3L / ESCAPE XLT 2001-2004 6C 2.3L / |  | CF10137      | FRAM     |
|   |  | CFI-YL84     | INTERFIL |
|   |  | 24816        | WIX      |

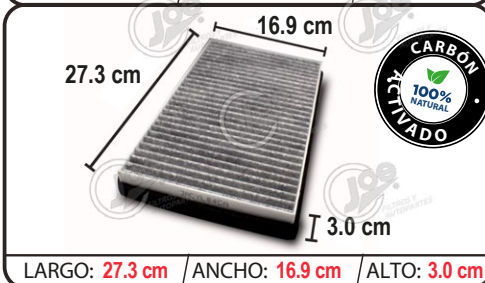

| FORD  |  | JACYL84CA    |          |
|---|--|--------------|----------|
| APLICACIÓN  |  | EQUIVALENCIA |          |
| ESCAPE 2013 4C 1.6L TURBO / ESCAPE 2001-2013 4C 2.0L / ESCAPE 2005-2006 4C 2.3L / ESCAPE 2001-2012 6C 3.0L / ESCAPE HIBRIDO 2005-2006 4C 2.3L / ESCAPE XLS 2001-2004 6C 2.3L / ESCAPE XLT 2001-2004 6C 2.3L / |  | CF10137      | FRAM     |
|   |  | CFI-YL84CA   | INTERFIL |
|   |  | 24816        | WIX      |

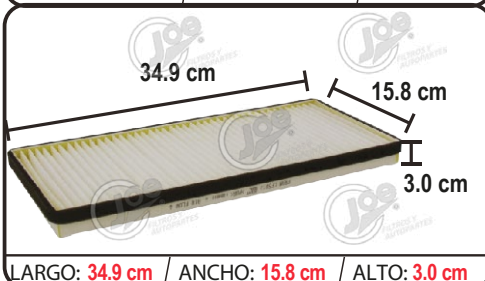

| FORD  |  | JAC96FW      |          |
|---|--|--------------|----------|
| APLICACIÓN  |  | EQUIVALENCIA |          |
| COURIER 2001-2007 4C 1.6L / COURIER L 2003-2006 4C 1.6L / COURIER XL 2003-2006 4C 1.6L / KA 2001-2007 4C 1.6L / 2001-2004 6C 2.3L / |  | N/D          | FRAM     |
|   |  | CFI-96FW     | INTERFIL |
|   |  | WP6820       | WIX      |



|   |  |   |          |      |            |          |         |     |
|---|--|---|----------|------|------------|----------|---------|-----|
|  <p>15.8 cm<br/>34.9 cm<br/>3 cm</p> <p>ARGO: 34.9 cm / ANCHO: 15.8 cm / ALTO: 3.0 cm</p>     | <p><b>FORD</b></p> <p>APLICACIÓN</p> <p>COURRIER 2001-2007 4C 1.6L / COURRIER L 2003-2006 4C 1.6L / COURRIER XL 2003-2006 4C 1.6L / KA 2001-2007 4C 1.6L / 2001-2004 6C 2.3L /</p>                             | <p><b>JAC96FWCA</b></p> <p>EQUIVALENCIA</p> <table border="1"> <tr><td>N/D</td><td>FRAM</td></tr> <tr><td>CFI-96FWCA</td><td>INTERFIL</td></tr> <tr><td>WP6820</td><td>WIX</td></tr> </table>     | N/D      | FRAM | CFI-96FWCA | INTERFIL | WP6820  | WIX |
| N/D   | FRAM   |   |          |      |            |          |         |     |
| CFI-96FWCA  | INTERFIL   |   |          |      |            |          |         |     |
| WP6820  | WIX  |   |          |      |            |          |         |     |
|  <p>20 cm<br/>25.8 cm<br/>3.2 cm</p> <p>ARGO: 25.8 cm / ANCHO: 20 cm / ALTO: 3.2 cm</p>       | <p><b>FORD</b></p> <p>APLICACIÓN</p> <p>MUSTANG 2015-2019 4C 2.3L / MUSTANG 2015-2019 6C 3.7L / MUSTANG 2015-2019 8C 5.0L /</p>  | <p><b>JAC10195CA</b></p> <p>EQUIVALENCIA</p> <table border="1"> <tr><td>N/D</td><td>FRAM</td></tr> <tr><td>CFI-10195</td><td>INTERFIL</td></tr> <tr><td>WP10195</td><td>WIX</td></tr> </table>    | N/D      | FRAM | CFI-10195  | INTERFIL | WP10195 | WIX |
| N/D   | FRAM   |   |          |      |            |          |         |     |
| CFI-10195   | INTERFIL   |   |          |      |            |          |         |     |
| WP10195   | WIX  |   |          |      |            |          |         |     |
|  <p>21.1 CM<br/>18.1 CM<br/>2.5 CM</p> <p>ARGO: 21.1 cm / ANCHO: 18.1 cm / ALTO: 2.5 cm</p>  | <p><b>FORD</b></p> <p>APLICACIÓN</p> <p>MUSTANG 2011-2015 6C 3.7L / MUSTANG 2005-2010 6C 4.0L / MUSTANG 2005-2010 8C 4.6L / MUSTANG 2011-2015 8C 5.0L / MUSTANG 2007-2014 8C 5.4L / MUSTANG 2013 8C 5.8L /</p> | <p><b>JAC10370</b></p> <p>EQUIVALENCIA</p> <table border="1"> <tr><td>CF10370</td><td>FRAM</td></tr> <tr><td>CF10370</td><td>INTERFIL</td></tr> <tr><td>24687</td><td>WIX</td></tr> </table>      | CF10370  | FRAM | CF10370    | INTERFIL | 24687   | WIX |
| CF10370   | FRAM   |   |          |      |            |          |         |     |
| CF10370   | INTERFIL   |   |          |      |            |          |         |     |
| 24687   | WIX  |   |          |      |            |          |         |     |
|  <p>20.6 cm<br/>17.9 cm<br/>2.5 cm</p> <p>ARGO: 20.6 cm / ANCHO: 17.9 cm / ALTO: 2.5 cm</p> | <p><b>FORD</b></p> <p>APLICACIÓN</p> <p>MUSTANG 2011-2015 6C 3.7L / MUSTANG 2005-2010 6C 4.0L / MUSTANG 2005-2010 8C 4.6L / MUSTANG 2011-2015 8C 5.0L / MUSTANG 2007-2014 8C 5.4L / MUSTANG 2013 8C 5.8L /</p> | <p><b>JAC10370CA</b></p> <p>EQUIVALENCIA</p> <table border="1"> <tr><td>CF10370</td><td>FRAM</td></tr> <tr><td>CF10370</td><td>INTERFIL</td></tr> <tr><td>24687</td><td>WIX</td></tr> </table>    | CF10370  | FRAM | CF10370    | INTERFIL | 24687   | WIX |
| CF10370   | FRAM   |   |          |      |            |          |         |     |
| CF10370   | INTERFIL   |   |          |      |            |          |         |     |
| 24687   | WIX  |   |          |      |            |          |         |     |
|  <p>22 cm<br/>22 cm<br/>3.3 cm</p> <p>ARGO: 22 cm / ANCHO: 22 cm / ALTO: 3.3 cm</p>         | <p><b>FORD</b></p> <p>APLICACIÓN</p> <p>FORD EDGE 3.5 L 6 CIL. 2007- 2015</p>  | <p><b>JAC10547CA</b></p> <p>EQUIVALENCIA</p> <table border="1"> <tr><td>CF-10547</td><td>FRAM</td></tr> <tr><td>CFI-10547</td><td>INTERFIL</td></tr> <tr><td>24065</td><td>WIX</td></tr> </table> | CF-10547 | FRAM | CFI-10547  | INTERFIL | 24065   | WIX |
| CF-10547  | FRAM   |   |          |      |            |          |         |     |
| CFI-10547   | INTERFIL   |   |          |      |            |          |         |     |
| 24065   | WIX  |   |          |      |            |          |         |     |
|  <p>3.3 CM<br/>21.0 CM<br/>26.5 CM</p> <p>ARGO: 26.5 cm / ANCHO: 21 cm / ALTO: 3.3 cm</p>   | <p><b>FORD</b></p> <p>APLICACIÓN</p> <p>FUSION 2010-2012 4C 2.5L / FUSION 2010-2012 6C 3.0L / FUSION 2010-2012 6C 3.8L /</p>   | <p><b>JAC11174</b></p> <p>EQUIVALENCIA</p> <table border="1"> <tr><td>CF11174</td><td>FRAM</td></tr> <tr><td>N/D</td><td>INTERFIL</td></tr> <tr><td>24367</td><td>WIX</td></tr> </table>          | CF11174  | FRAM | N/D        | INTERFIL | 24367   | WIX |
| CF11174   | FRAM   |   |          |      |            |          |         |     |
| N/D   | INTERFIL   |   |          |      |            |          |         |     |
| 24367   | WIX  |   |          |      |            |          |         |     |

|   |   |  |         |      |           |          |       |     |
|---|---|--|---------|------|-----------|----------|-------|-----|
|  <p>LARGO: 26.5 cm / ANCHO: 21 cm / ALTO: 3.3 cm</p>     | <p><b>FORD</b></p> <p>APLICACIÓN</p> <p>FUSION 2010-2012 4C 2.5L / FUSION 2010-2012 6C 3.0L / FUSION 2010-2012 6C 3.8L /</p>  | <p><b>JAC11174CA</b></p> <p>EQUIVALENCIA</p> <table border="1"> <tr><td>CF11174</td><td>FRAM</td></tr> <tr><td>N/D</td><td>INTERFIL</td></tr> <tr><td>24367</td><td>WIX</td></tr> </table>       | CF11174 | FRAM | N/D       | INTERFIL | 24367 | WIX |
| CF11174   | FRAM  |  |         |      |           |          |       |     |
| N/D   | INTERFIL  |  |         |      |           |          |       |     |
| 24367   | WIX   |  |         |      |           |          |       |     |
|  <p>LARGO: 22.6 cm / ANCHO: 18.9 cm / ALTO: 2.4 cm</p>   | <p><b>FORD</b></p> <p>APLICACIÓN</p> <p>EXPLORER 2011-2019 6C 3.5L /</p>  | <p><b>JAC11176</b></p> <p>EQUIVALENCIA</p> <table border="1"> <tr><td>CF11176</td><td>FRAM</td></tr> <tr><td>CFI-11176</td><td>INTERFIL</td></tr> <tr><td>24068</td><td>WIX</td></tr> </table>   | CF11176 | FRAM | CFI-11176 | INTERFIL | 24068 | WIX |
| CF11176   | FRAM  |  |         |      |           |          |       |     |
| CFI-11176   | INTERFIL  |  |         |      |           |          |       |     |
| 24068   | WIX   |  |         |      |           |          |       |     |
|  <p>LARGO: 22.4 cm / ANCHO: 18.9 cm / ALTO: 2.4 cm</p>  | <p><b>FORD</b></p> <p>APLICACIÓN</p> <p>EXPLORER 2011-2019 6C 3.5L /</p>  | <p><b>JAC11176CA</b></p> <p>EQUIVALENCIA</p> <table border="1"> <tr><td>CF11176</td><td>FRAM</td></tr> <tr><td>CFI-11176</td><td>INTERFIL</td></tr> <tr><td>24068</td><td>WIX</td></tr> </table> | CF11176 | FRAM | CFI-11176 | INTERFIL | 24068 | WIX |
| CF11176   | FRAM  |  |         |      |           |          |       |     |
| CFI-11176   | INTERFIL  |  |         |      |           |          |       |     |
| 24068   | WIX   |  |         |      |           |          |       |     |
|  <p>LARGO: 23.4 cm / ANCHO: 21.5 cm / ALTO: 3 cm</p>   | <p><b>FORD</b></p> <p>APLICACIÓN</p> <p>RANGER PICK UP DIESEL 2019-2020 2.2 Y 3.2L</p>  | <p><b>JAC11548CA</b></p> <p>EQUIVALENCIA</p> <table border="1"> <tr><td>N/D</td><td>FRAM</td></tr> <tr><td>N/D</td><td>INTERFIL</td></tr> <tr><td>N/D</td><td>WIX</td></tr> </table>             | N/D     | FRAM | N/D       | INTERFIL | N/D   | WIX |
| N/D   | FRAM  |  |         |      |           |          |       |     |
| N/D   | INTERFIL  |  |         |      |           |          |       |     |
| N/D   | WIX   |  |         |      |           |          |       |     |
|  <p>LARGO: 21.9 cm / ANCHO: 21.4 cm / ALTO: 2.5 cm</p> | <p><b>FREIGHTLINER</b></p> <p>APLICACIÓN</p> <p>MODELOS TODOS, M2 2003&gt;2023<br/>MANN CU2228 PUROLATOR C15915 FLEETGUARD<br/>AF2421SAKURA CA79210 BALDWIN PA5359<br/>DONALSON P614547</p> | <p><b>JAC10188CA</b></p> <p>EQUIVALENCIA</p> <table border="1"> <tr><td>PA10188</td><td>FRAM</td></tr> <tr><td>N/D</td><td>INTERFIL</td></tr> <tr><td>49082</td><td>WIX</td></tr> </table>       | PA10188 | FRAM | N/D       | INTERFIL | 49082 | WIX |
| PA10188   | FRAM  |  |         |      |           |          |       |     |
| N/D   | INTERFIL  |  |         |      |           |          |       |     |
| 49082   | WIX   |  |         |      |           |          |       |     |
|  <p>LARGO: 24.2 cm / ANCHO: 20.2 cm / ALTO: 3 cm</p>   | <p><b>GMC</b></p> <p>APLICACIÓN</p> <p>ACADIA 2017 4C 2.5L / ACADIA 2017-2019 6C 3.6L /</p>   | <p><b>JAC1350</b></p> <p>EQUIVALENCIA</p> <table border="1"> <tr><td>CF11966</td><td>FRAM</td></tr> <tr><td>CFI-1350</td><td>INTERFIL</td></tr> <tr><td>24211</td><td>WIX</td></tr> </table>     | CF11966 | FRAM | CFI-1350  | INTERFIL | 24211 | WIX |
| CF11966   | FRAM  |  |         |      |           |          |       |     |
| CFI-1350  | INTERFIL  |  |         |      |           |          |       |     |
| 24211   | WIX   |  |         |      |           |          |       |     |

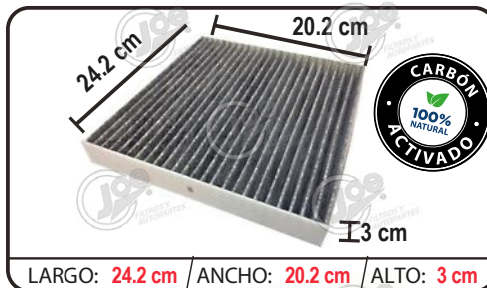

| GMC  |  | JAC1350CA    |          |
|--|--|--------------|----------|
| APLICACIÓN                                       |  | EQUIVALENCIA |          |
| ACADIA 2017 4C 2.5L / ACADIA 2017-2019 6C 3.6L / |  | CF11966      | FRAM     |
|  |  | CFI-1350     | INTERFIL |
|  |  | 24211        | WIX      |

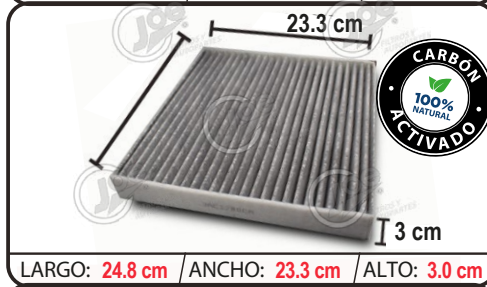

| GMC   |  | JAC2280CA    |          |
|---|--|--------------|----------|
| APLICACIÓN  |  | EQUIVALENCIA |          |
| DENALI 2014-2015 8C 6.2L / SIERRA DENALI 2014-2019 8C 6.2L / SIERRA REGULAR 2014-2019 8C 5.3L / YUKON 2014-2019 8C 6.2L / |  | N/D          | FRAM     |
|   |  | CFI-2280     | INTERFIL |
|   |  | WP10129      | WIX      |

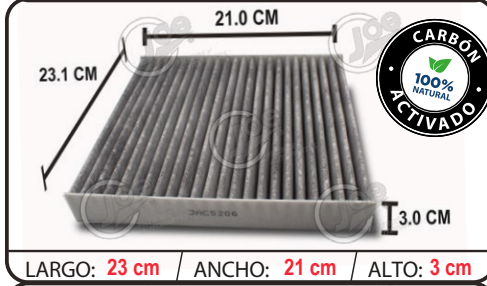

| GMC  |  | JAC5206CA    |          |
|--|--|--------------|----------|
| APLICACIÓN   |  | EQUIVALENCIA |          |
| COLORADO 2015-2019 2.5 LTS. 4 CIL. / 3.6 LTS. V6<br>SIERRA 2014, 4.3 LTS. V8 / 5.3 LTS. V8 |  | N/D          | FRAM     |
|  |  | N/D          | INTERFIL |
|  |  | N/D          | WIX      |

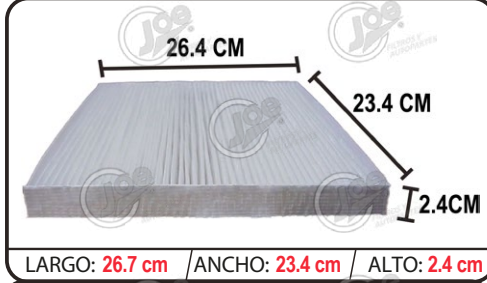

| GMC   |  | JAC8898      |          |
|---|--|--------------|----------|
| APLICACIÓN  |  | EQUIVALENCIA |          |
| SIERRA 1500 PICK UP 2003-2004 6C 4.3L / SIERRA 1500 PICK UP 2003-2004 6C 4.8L / SIERRA 1500 PICK UP 2003-2004 6C 5.3L / SIERRA 2500 PICK UP 2003-2004 8C 5.3L / SIERRA 3500 PICK UP 2003-2004 8C 6.0L / SIERRA 3500 PICK UP 2003-2004 8C 6.6 TURBO DIESEL / SIERRA 3500 PICK UP 2003-2004 8C 8.1L / YUKON 2003-2004 8C 4.8L / YUKON 2003-2004 8C 5.3L / |  | CF10360      | FRAM     |
|   |  | CFI-8898     | INTERFIL |
|   |  | 24814        | WIX      |

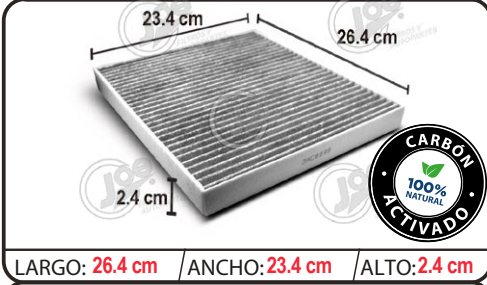

| GMC   |  | JAC8898CA    |          |
|---|--|--------------|----------|
| APLICACIÓN  |  | EQUIVALENCIA |          |
| SIERRA 1500 PICK UP 2003-2004 6C 4.3L / SIERRA 1500 PICK UP 2003-2004 6C 4.8L / SIERRA 1500 PICK UP 2003-2004 6C 5.3L / SIERRA 2500 PICK UP 2003-2004 8C 5.3L / SIERRA 3500 PICK UP 2003-2004 8C 6.0L / SIERRA 3500 PICK UP 2003-2004 8C 6.6 TURBO DIESEL / SIERRA 3500 PICK UP 2003-2004 8C 8.1L / YUKON 2003-2004 8C 4.8L / YUKON 2003-2004 8C 5.3L / |  | CF10360      | FRAM     |
|   |  | CFI-8898     | INTERFIL |
|   |  | 24814        | WIX      |

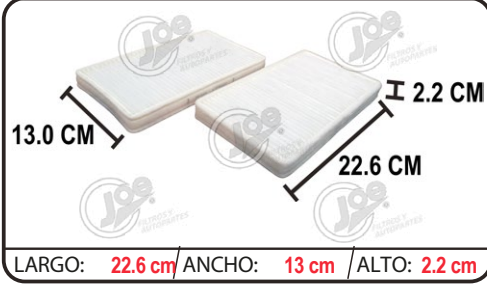

| GMC   |  | JAC9910      |          |
|---|--|--------------|----------|
| APLICACIÓN  |  | EQUIVALENCIA |          |
| SIERRA 1500 PICK UP 2000-2002 6C 4.3L / SIERRA 1500 PICK UP 2000-2002 8C 4.8L / SIERRA 1500 PICK UP 2000-2002 8C 5.3L / SIERRA 1500 PICK UP 2000-2002 8C 6.0L / SIERRA 2500 HD PICK UP 2001-2002 8C 6.1L / SIERRA 2500 PICK UP 8C 5.3L / SIERRA 2500 PICK UP 2001-2002 8C 6.0L / SIERRA 3500 PICK UP 2001-2002 8C 5.7L / DENALI PICK UP 2002 8C 5.7L / YUKON 2001-2002 8C 5.7L / SIERRA YUKON 2001-2002 8C 6.0L / |  | CF8791       | FRAM     |
|   |  | CFI-9910     | INTERFIL |
|   |  | 24805        | WIX      |

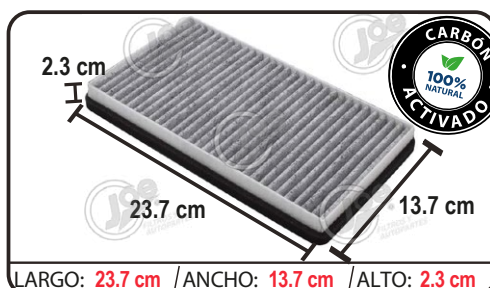

| GMC   |  | JAC9910CA    |                 |
|---|--|--------------|-----------------|
| APLICACIÓN  |  | EQUIVALENCIA |                 |
| SIERRA 1500 PICK UP 2000-2002 6C 4.3L / SIERRA 1500 PICK UP 2000-2002 8C 4.8L / SIERRA 1500 PICK UP 2000-2002 8C 5.3L / SIERRA 1500 PICK UP 2000-2002 8C 6.0L / SIERRA 2500 HD PICK UP 2001-2002 8C 6.1L / SIERRA 2500 PICK UP 8C 5.3L / SIERRA 2500 PICK UP 2001-2002 8C 6.0L / SIERRA 3500 PICK UP 2001-2002 8C 5.7L / DENALI PICK UP 2002 8C 5.7L / YUKON 2001-2002 8C 5.7L / SIERRA YUKON 2001-2002 8C 6.0L / |  | CF8791       | <b>FRAM</b>     |
|   |  | CFI-9910     | <b>INTERFIL</b> |
|   |  | 24805        | <b>WIX</b>      |

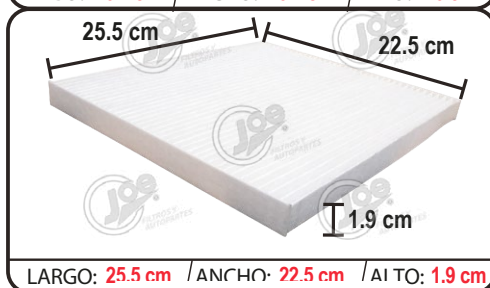

| GMC                         |  | JAC10742     |                 |
|-----------------------------|--|--------------|-----------------|
| APLICACIÓN                  |  | EQUIVALENCIA |                 |
| TERRAIN 2010-2019 6C 3.6L / |  | CF10742      | <b>FRAM</b>     |
|                             |  | CFI-10742    | <b>INTERFIL</b> |
|                             |  | 49368        | <b>WIX</b>      |

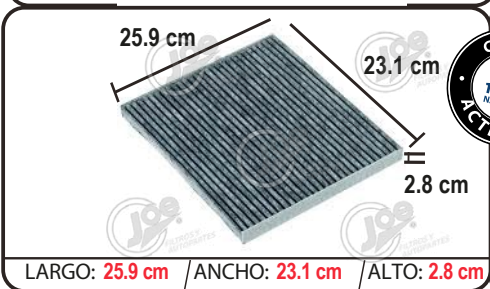

| GMC                         |  | JAC10742CA   |                 |
|-----------------------------|--|--------------|-----------------|
| APLICACIÓN                  |  | EQUIVALENCIA |                 |
| TERRAIN 2010-2019 6C 3.6L / |  | CF10742      | <b>FRAM</b>     |
|                             |  | CFI-10742    | <b>INTERFIL</b> |
|                             |  | 49368        | <b>WIX</b>      |

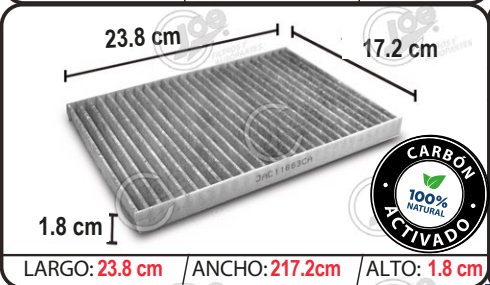

| GMC                        |  | JAC11663CA   |                 |
|----------------------------|--|--------------|-----------------|
| APLICACIÓN                 |  | EQUIVALENCIA |                 |
| ACADIA 2007-2016 6C 3.6L / |  | CF11663      | <b>FRAM</b>     |
|                            |  | CFI-11663    | <b>INTERFIL</b> |
|                            |  | WP10074      | <b>WIX</b>      |

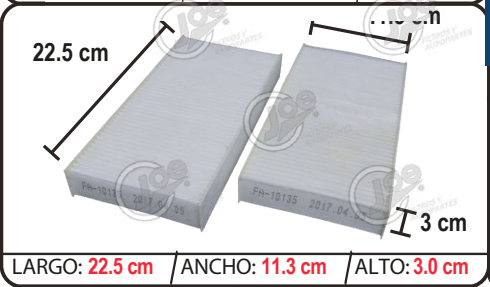

| HONDA  |  | JAC2S5A      |                 |
|--|--|--------------|-----------------|
| APLICACIÓN   |  | EQUIVALENCIA |                 |
| CIVIC 1996-2000 4C 1.6L / CIVIC 2001-2005 4C 1.7L / CIVIC 2002-2005 4C 2.0L / CIVIC EXR 1999-2000 4C 1.6L / CIVIC SIR 1999-2000 4C 1.6L / CR-V 2007 4C 2.0L / CR-V 2002-2006 4C 2.4L / ELEMENT 2003-2011 4C 2.4L / |  | CF10135      | <b>FRAM</b>     |
|  |  | CFI-2S5A     | <b>INTERFIL</b> |
|  |  | 24817        | <b>WIX</b>      |

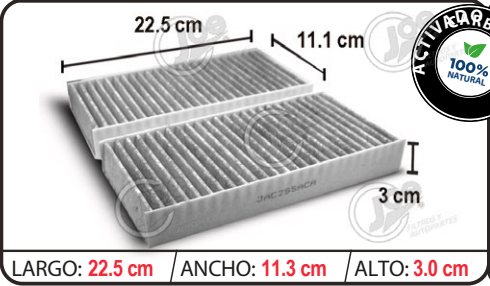

| HONDA  |  | JAC2S5ACA    |                 |
|--|--|--------------|-----------------|
| APLICACIÓN   |  | EQUIVALENCIA |                 |
| CIVIC 1996-2000 4C 1.6L / CIVIC 2001-2005 4C 1.7L / CIVIC 2002-2005 4C 2.0L / CIVIC EXR 1999-2000 4C 1.6L / CIVIC SIR 1999-2000 4C 1.6L / CR-V 2007 4C 2.0L / CR-V 2002-2006 4C 2.4L / ELEMENT 2003-2011 4C 2.4L / |  | CF10135      | <b>FRAM</b>     |
|  |  | CFI-2S5ACA   | <b>INTERFIL</b> |
|  |  | 24817        | <b>WIX</b>      |

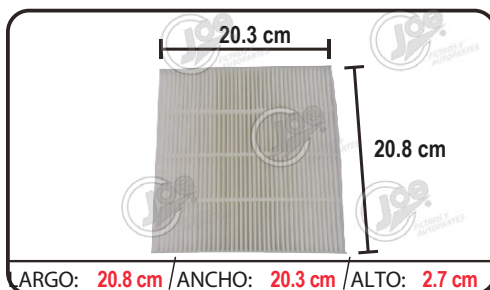

| HONDA   |  | JAC2915      |          |
|---|--|--------------|----------|
| APLICACIÓN  |  | EQUIVALENCIA |          |
| BR-V 2018-2020 4C 1.5L / CITY 2014-2020 4C 1.5L / CR-V 2017-2020 4C 1.5L TURBO / FIT 2015-2020 4C 1.5L / HR-V 2015-2020 4C 1.8L / ODYSSEY 2018-2020 6C 3.5L / |  | N/D          | FRAM     |
|   |  | CFI-2915     | INTERFIL |
|   |  | WP49101      | WIX      |



| HONDA   |  | JAC2915CA    |          |
|---|--|--------------|----------|
| APLICACIÓN  |  | EQUIVALENCIA |          |
| BR-V 2018-2020 4C 1.5L / CITY 2014-2020 4C 1.5L / CR-V 2017-2020 4C 1.5L TURBO / FIT 2015-2020 4C 1.5L / HR-V 2015-2020 4C 1.8L / ODYSSEY 2018-2020 6C 3.5L / |  | N/D          | FRAM     |
|   |  | CFI-2915     | INTERFIL |
|   |  | WP49101      | WIX      |

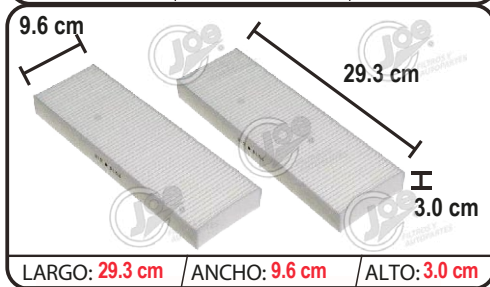

| HONDA   |  | JAC8029      |          |
|---|--|--------------|----------|
| APLICACIÓN  |  | EQUIVALENCIA |          |
| ACCORD 1998-2002 4C 3.2L / ACCORD 1998-2002 6C 3.0L / ACCORD EXR 2001 4C 2.2L / |  | CF10135      | FRAM     |
|   |  | CFI-8029     | INTERFIL |
|   |  | 24752        | WIX      |

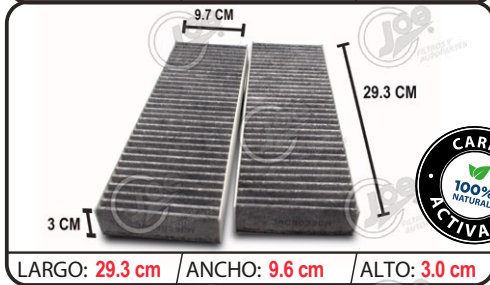

| HONDA   |  | JAC8029CA    |          |
|---|--|--------------|----------|
| APLICACIÓN  |  | EQUIVALENCIA |          |
| ACCORD 1998-2002 4C 3.2L / ACCORD 1998-2002 6C 3.0L / ACCORD EXR 2001 4C 2.2L / |  | CF10135      | FRAM     |
|   |  | CFI-8029     | INTERFIL |
|   |  | 24752        | WIX      |

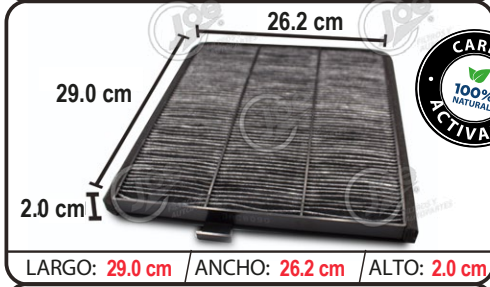

| HONDA   |  | JAC8090CA    |      |
|---|--|--------------|------|
| APLICACIÓN  |  | EQUIVALENCIA |      |
| ODYSSEY 1999-2004 6C 3.5L / PILOT 1999-2003 6C 3.5L / |  | CF8813       | FRAM |
|   |  | CFI-8090     | MANN |
|   |  | 24897        | WIX  |

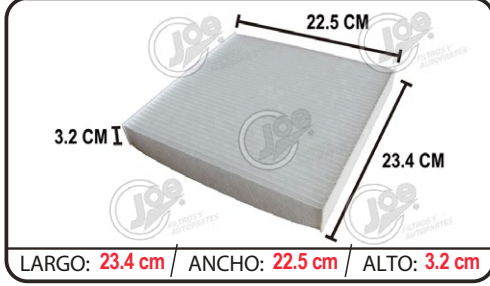

| HONDA   |  | JAC8092      |          |
|---|--|--------------|----------|
| APLICACIÓN  |  | EQUIVALENCIA |          |
| ACCORD 2018-2019 4C 1.5L TURBO / ACCORD 2018-2019 4C 2.0L TURBO / HACCORD 2003-2019 4C 2.4L / ACCORD 2003-2007 6C 3.0L / ACCORD 2008-2018 6C 3.5L / ACCORD COUPE 2006-2008 4C 2.4L / ACCORD CROSSTOUR 2010-2012 6C 3.5L / ACCORD EX 2006 6C 3.5L / ACCORD HIBRIDO 2014 4C 2.0L / CIVIC 2016-2019 4C 1.5L TURBO / CIVIC 2006-2015 4C 1.8L / CIVIC 2006-2019 4C 2.0L / CIVIC 2012-2015 4C 2.4L / CIVIC HIBRIDO 2006-2011 4C 1.3L / CIVIC HIBRIDO 2012-2015 4C 1.5L / CIVIC SI 2006-2011 4C 2.0L / CIVIC SI 2012-2013 4C 2.2L / CROSSTOUR 2012-2015 4C 2.4L / CR-V 2007-2019 4C 2.4L / ODYSSEY 2005-2017 6C 3.5L / PILOT 2009-2017 6C 3.5L / RIDGELINE 2006-2014 6C 3.5L / |  | CF10134      | FRAM     |
|   |  | CFI-8092CA   | INTERFIL |
|   |  | 24815        | WIX      |

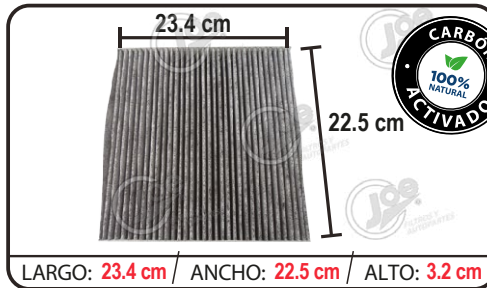

| HONDA  |  | JAC8092CA    |          |
|--|--|--------------|----------|
| APLICACIÓN   |  | EQUIVALENCIA |          |
| ACCORD 2018-2019 4C 1.5L TURBO / ACCORD 2018-2019 4C 2.0L TURBO /<br>HACCORD 2003-2019 4C 2.4L / ACCORD 2003-2007 6C 3.0L / ACCORD<br>2008-2018 6C 3.5L / ACCORD COUPE 2006-2008 4C 2.4L / ACCORD<br>CROSSTOUR 2010-2012 6C 3.5L / ACCORD EX 2006 6C 3.5L / ACCORD<br>HIBRIDO 2014 4C 2.0L / CIVIC 2016-2019 4C 1.5L TURBO / CIVIC 2006-2015<br>4C 1.8L / CIVIC 2006-2019 4C 2.0L / CIVIC 2012-2015 4C 2.4L / CIVIC HIBRIDO<br>2006-2011 4C 1.3L / CIVIC HIBRIDO 2012-2015 4C 1.5L / CIVIC SI 2006-2011<br>4C 2.0L / CIVIC SI 2012-2013 4C 2.2L / CROSSTOUR 2012-2015 4C 2.4L / CR-V<br>2007-2019 4C 2.4L / ODYSSEY 2005-2017 6C 3.5L / PILOT 2009-2017 6C 3.5L /<br>RIDGELINE 2006-2014 6C 3.5L / |  | CF10134      | FRAM     |
|  |  | CFI-8092CA   | INTERFIL |
|  |  | 24815        | WIX      |

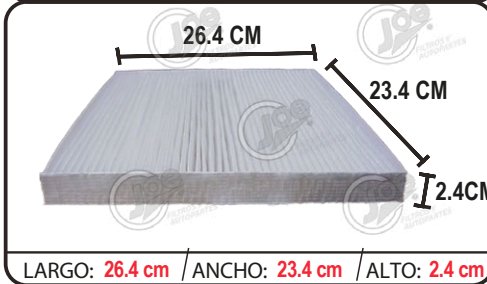

| HUMMER  |  | JAC8898      |          |
|---|--|--------------|----------|
| APLICACIÓN  |  | EQUIVALENCIA |          |
| H2 2003-2007 8C 6.0L / H2 2008-2010 8C 6.2L / H2<br>SUT 2008-2009 8C 6.2L / |  | CF10360      | FRAM     |
|   |  | CFI-8898     | INTERFIL |
|   |  | 24814        | WIX      |

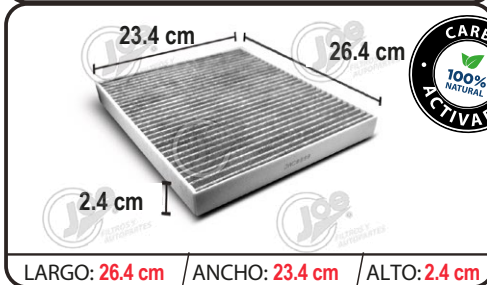

| HUMMER  |  | JAC8898CA    |          |
|---|--|--------------|----------|
| APLICACIÓN  |  | EQUIVALENCIA |          |
| H2 2003-2007 8C 6.0L / H2 2008-2010 8C 6.2L / H2<br>SUT 2008-2009 8C 6.2L / |  | CF10360      | FRAM     |
|   |  | CFI-8898     | INTERFIL |
|   |  | 24814        | WIX      |

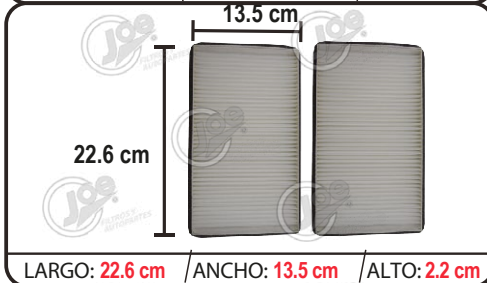

| HUMMER            |  | JAC9910      |          |
|-------------------|--|--------------|----------|
| APLICACIÓN        |  | EQUIVALENCIA |          |
| H2 2002 8C 6.0L / |  | CF8791       | FRAM     |
|                   |  | CFI-9910     | INTERFIL |
|                   |  | 24805        | WIX      |



| HUMMER            |  | JAC9910CA    |          |
|-------------------|--|--------------|----------|
| APLICACIÓN        |  | EQUIVALENCIA |          |
| H2 2002 8C 6.0L / |  | CF8791       | FRAM     |
|                   |  | CFI-9910     | INTERFIL |
|                   |  | 24805        | WIX      |

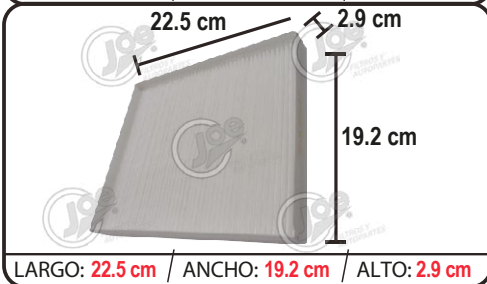

| HYUNDAI   |  | JAC1332      |          |
|---|--|--------------|----------|
| APLICACIÓN  |  | EQUIVALENCIA |          |
| CADENZA 2017 4C 3.3L / SONATA 2015-2019 4C 1.6L<br>/ SONATA 2015-2017 4C 2.0L / HYUNDAY SONATA<br>2017-2019 4C 2.0L TURBO / SONATA 2015-2018 4C<br>2.4L / |  | N/D          | FRAM     |
|   |  | CFI-1332     | INTERFIL |
|   |  | WP10155      | WIX      |





| HYUNDAI  |  | JAC1332CA    |                 |
|--|--|--------------|-----------------|
| APLICACIÓN   |  | EQUIVALENCIA |                 |
| CADENZA 2017 4C 3.3L / SONATA 2015-2019 4C 1.6L / SONATA 2015-2017 4C 2.0L / HYUNDAI SONATA 2017-2019 4C 2.0L TURBO / SONATA 2015-2018 4C 2.4L / |  | N/D          | <b>FRAM</b>     |
|  |  | CFI-1332     | <b>INTERFIL</b> |
|  |  | WP10155      | <b>WIX</b>      |

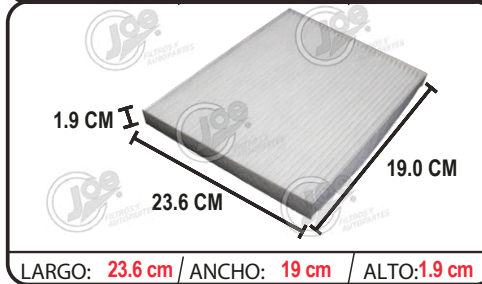

| HYUNDAI                    |  | JAC3321      |                 |
|----------------------------|--|--------------|-----------------|
| APLICACIÓN                 |  | EQUIVALENCIA |                 |
| TUCSON 2016-2018 4C 2.0L / |  | N/D          | <b>FRAM</b>     |
|                            |  | CFI-3321     | <b>INTERFIL</b> |
|                            |  | N/D          | <b>WIX</b>      |

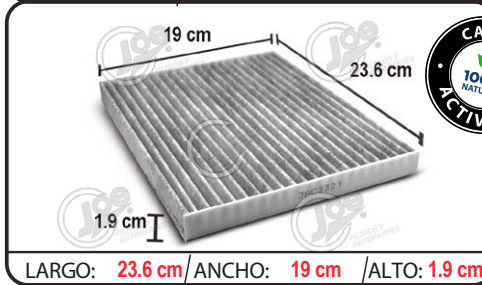

| HYUNDAI                    |  | JAC3321CA    |                 |
|----------------------------|--|--------------|-----------------|
| APLICACIÓN                 |  | EQUIVALENCIA |                 |
| TUCSON 2016-2018 4C 2.0L / |  | N/D          | <b>FRAM</b>     |
|                            |  | CFI-3321     | <b>INTERFIL</b> |
|                            |  | N/D          | <b>WIX</b>      |

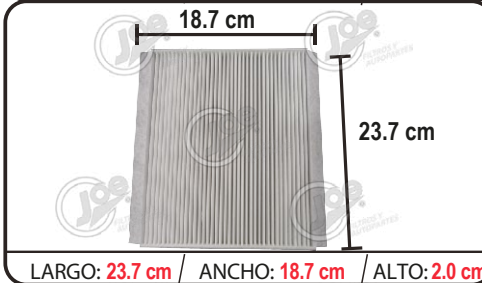

| HYUNDAI  |  | JAC7133      |                 |
|--|--|--------------|-----------------|
| APLICACIÓN   |  | EQUIVALENCIA |                 |
| ACCENT 2008-2011 4C 1.6L / CRETA 2017-2019 4C 1.6L / ELANTRA 2007-2017 4C 2.0L / |  | N/D          | <b>FRAM</b>     |
|  |  | CFI-7133     | <b>INTERFIL</b> |
|  |  | 49377        | <b>WIX</b>      |

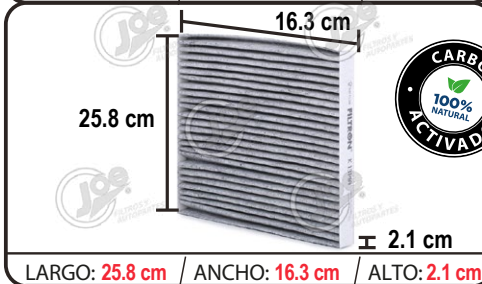

| HYUNDAI  |  | JAC7133CA    |                 |
|--|--|--------------|-----------------|
| APLICACIÓN   |  | EQUIVALENCIA |                 |
| ACCENT 2008-2011 4C 1.6L / CRETA 2017-2019 4C 1.6L / ELANTRA 2007-2017 4C 2.0L / |  | N/D          | <b>FRAM</b>     |
|  |  | CFI-7133     | <b>INTERFIL</b> |
|  |  | 49377        | <b>WIX</b>      |



| HYUNDAI   |  | JAC9713      |                 |
|---|--|--------------|-----------------|
| APLICACIÓN  |  | EQUIVALENCIA |                 |
| ACCENT 2005-2008 1.4 LTS. 4 CIL. / ATTITUDE 2005-2010 1.6 LTS. 4 CIL. / |  | CF10719      | <b>FRAM</b>     |
|   |  | CU2331       | <b>INTERFIL</b> |
|   |  | 24484        | <b>WIX</b>      |

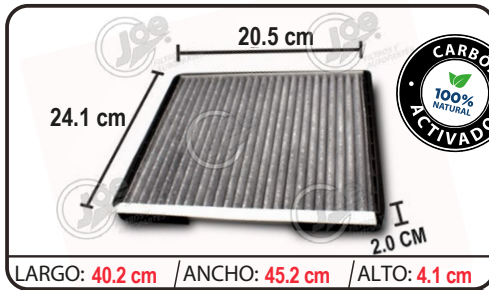

| HYUNDAI   |  | JAC9713CA    |          |
|---|--|--------------|----------|
| APLICACIÓN  |  | EQUIVALENCIA |          |
| ACCENT 2005-2008 1.4 LTS. 4 CIL. /<br>ATTITUDE 2005-2010 1.6 LTS. 4 CIL./ |  | CF10719      | FRAM     |
|   |  | CU2331       | INTERFIL |
|   |  | 24484        | WIX      |

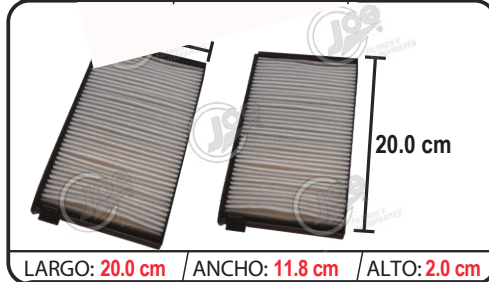

| HYUNDAI                        |  | JAC9761      |          |
|--------------------------------|--|--------------|----------|
| APLICACIÓN                     |  | EQUIVALENCIA |          |
| GRAND I-10 2015-2018 4C 1.2L / |  | N/D          | FRAM     |
|                                |  | CFI-9761     | INTERFIL |
|                                |  | WP2044       | WIX      |

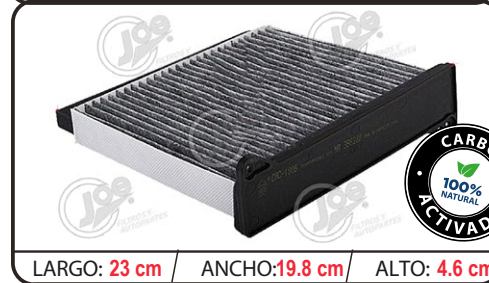

| HYUNDAI  |  | JAC10275CA   |          |
|--|--|--------------|----------|
| APLICACIÓN   |  | EQUIVALENCIA |          |
| SONATA, SANTA FE, AZERA / KIA SEDONA, CADENZA,<br>OPTIMA. MOD. 2010-2018 |  | N/D          | FRAM     |
|  |  | 97133- C1000 | INTERFIL |
|  |  | WP10275      | WIX      |

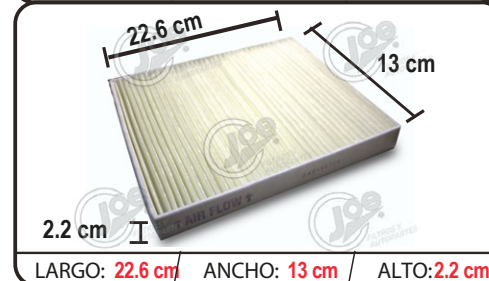

| HYUNDAI  |  | JAC10329     |          |
|--|--|--------------|----------|
| APLICACIÓN   |  | EQUIVALENCIA |          |
| ELANTRA 2001-2006 4C 2.0L / ENTOURAGE 2007-2010<br>6C 3.8L / TIBURON 2003-2008 4C 2.0L / TIBURON 2003-<br>2008 6C 2.7 L/ |  | CF10329      | FRAM     |
|  |  | CFI-9910     | INTERFIL |
|  |  | 24689        | WIX      |



| HYUNDAI  |  | JAC10329CA   |          |
|--|--|--------------|----------|
| APLICACIÓN   |  | EQUIVALENCIA |          |
| ELANTRA 2001-2006 4C 2.0L / ENTOURAGE 2007-2010<br>6C 3.8L / TIBURON 2003-2008 4C 2.0L / TIBURON 2003-<br>2008 6C 2.7 L/ |  | CF10329      | FRAM     |
|  |  | CFI-9910     | INTERFIL |
|  |  | 24689        | WIX      |

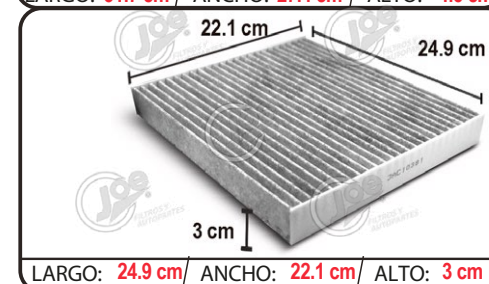

| HYUNDAI  |  | JAC10381     |          |
|--|--|--------------|----------|
| APLICACIÓN   |  | EQUIVALENCIA |          |
| HYUNDAI AZERA 2007-2008 6C 3.3L / AZERA 2006-2008<br>6C 3.8L / SANTA FE 2007-2009 6C 2.7L / SANTA FE<br>2007-2009 6C 3.3L / SONATA 2006-2010 4C 2.4L /<br>SONATA 2006-2010 6C 2.3L / |  | CF10381      | FRAM     |
|  |  | CFI-9910     | INTERFIL |
|  |  | 24517        | WIX      |





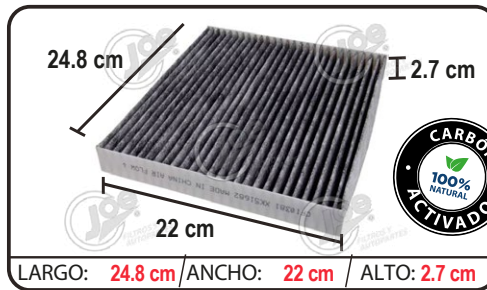

| HYUNDAI   |  | JAC10381CA   |          |
|---|--|--------------|----------|
| APLICACIÓN  |  | EQUIVALENCIA |          |
| HYUNDAI AZERA 2007-2008 6C 3.3L / AZERA 2006-2008 6C 3.8L / SANTA FE 2007-2009 6C 2.7L / SANTA FE 2007-2009 6C 3.3L / SONATA 2006-2010 4C 2.4L / SONATA 2006-2010 6C 2.3L / |  | CF10381      | FRAM     |
|   |  | CFI-9910     | INTERFIL |
|   |  | 24517        | WIX      |



| HYUNDAI                        |  | JAC10627     |          |
|--------------------------------|--|--------------|----------|
| APLICACIÓN                     |  | EQUIVALENCIA |          |
| GRAND i-10 2015-2018 4C 1.2L / |  | CF10627      | FRAM     |
|                                |  | CFI-10627    | INTERFIL |
|                                |  |              | WIX      |

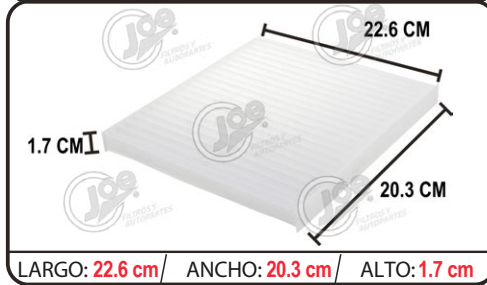

| HYUNDAI  |  | JAC10709     |          |
|--|--|--------------|----------|
| APLICACIÓN   |  | EQUIVALENCIA |          |
| ACCENT MOD. 2012-2017 4 CIL. 1.6 LTS. / GENESIS COUPE MOD. 2010-2014 4 CIL. 2.0 LTS / TUCSON MOD. 2005-2015 4 CIL. 2.0 LTS. / VELOSTER MOD. 2012-2017 4 CIL. 1.6 LTS |  | CF10709      | FRAM     |
|  |  | N/D          | INTERFIL |
|  |  | 24684        | WIX      |

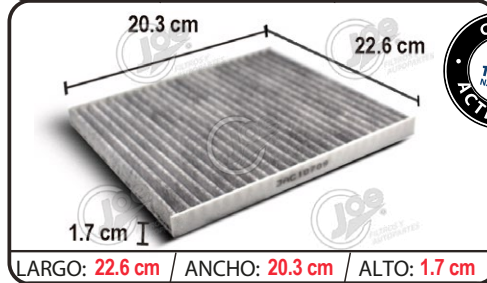

| HYUNDAI  |  | JAC10709CA   |          |
|--|--|--------------|----------|
| APLICACIÓN   |  | EQUIVALENCIA |          |
| ACCENT MOD. 2012-2017 4 CIL. 1.6 LTS. / GENESIS COUPE MOD. 2010-2014 4 CIL. 2.0 LTS / TUCSON MOD. 2005-2015 4 CIL. 2.0 LTS. / VELOSTER MOD. 2012-2017 4 CIL. 1.6 LTS |  | CF10709      | FRAM     |
|  |  | N/D          | INTERFIL |
|  |  | 24684        | WIX      |

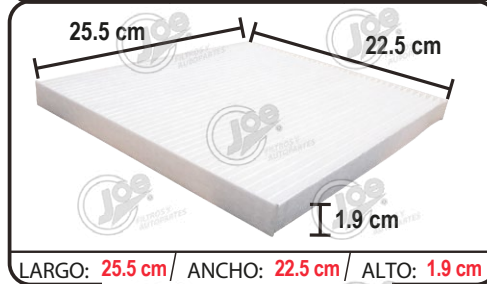

| HYUNDAI                            |  | JAC10742     |          |
|------------------------------------|--|--------------|----------|
| APLICACIÓN                         |  | EQUIVALENCIA |          |
| SANTE FE 2017-2018 4C 2.0L TURBO / |  | CF10742      | FRAM     |
|                                    |  | CFI-10742    | INTERFIL |
|                                    |  | 49368        | WIX      |

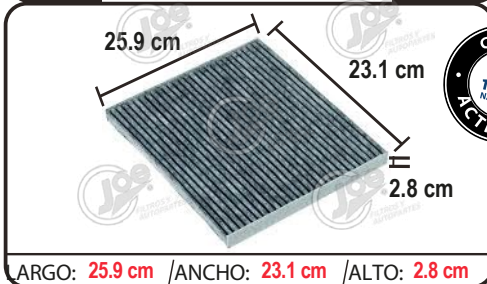

| HYUNDAI                            |  | JAC10742CA   |          |
|------------------------------------|--|--------------|----------|
| APLICACIÓN                         |  | EQUIVALENCIA |          |
| SANTE FE 2017-2018 4C 2.0L TURBO / |  | CF10742      | FRAM     |
|                                    |  | CFI-10742    | INTERFIL |
|                                    |  | 49368        | WIX      |



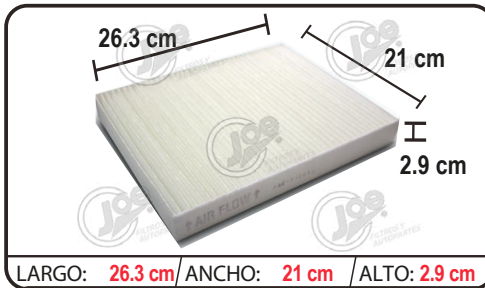

LARGO: 26.3 cm / ANCHO: 21 cm / ALTO: 2.9 cm

| HYUNDAI   |  | JAC11664     |                 |
|---|--|--------------|-----------------|
| APLICACIÓN  |  | EQUIVALENCIA |                 |
| SANTA FE 2010-2011 4C 2.4L / SANTA FE 2009 6C 2.7L / SANTA FE 2009-2011 6C 3.3L / |  | CF11664      | <b>FRAM</b>     |
|   |  | N/D          | <b>INTERFIL</b> |
|   |  | 24080        | <b>WIX</b>      |

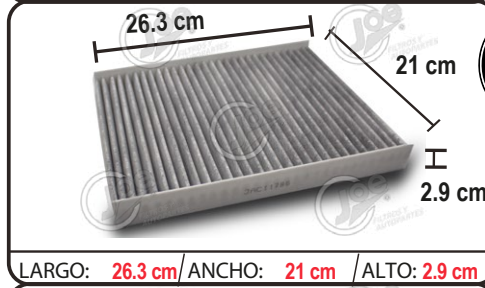

LARGO: 26.3 cm / ANCHO: 21 cm / ALTO: 2.9 cm

| HYUNDAI   |  | JAC11664CA   |                 |
|---|--|--------------|-----------------|
| APLICACIÓN  |  | EQUIVALENCIA |                 |
| SANTA FE 2010-2011 4C 2.4L / SANTA FE 2009 6C 2.7L / SANTA FE 2009-2011 6C 3.3L / |  | CF11664      | <b>FRAM</b>     |
|   |  | N/D          | <b>INTERFIL</b> |
|   |  | 24080        | <b>WIX</b>      |

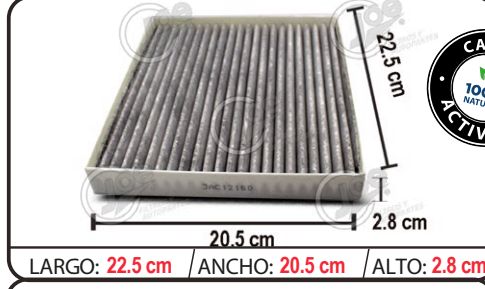

LARGO: 22.5 cm / ANCHO: 20.5 cm / ALTO: 2.8 cm

| HYUNDAI                       |  | JAC12160CA   |                 |
|-------------------------------|--|--------------|-----------------|
| APLICACIÓN                    |  | EQUIVALENCIA |                 |
| TUCSON TL 2016-2018 4C 2.0L / |  | N/D          | <b>FRAM</b>     |
|                               |  | N/D          | <b>INTERFIL</b> |
|                               |  | N/D          | <b>WIX</b>      |

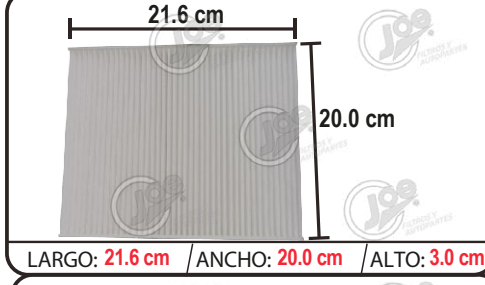

LARGO: 21.6 cm / ANCHO: 20.0 cm / ALTO: 3.0 cm

| INFINITI  |  | JAC999M      |                 |
|---|--|--------------|-----------------|
| APLICACIÓN  |  | EQUIVALENCIA |                 |
| FX35 2003-2008 6C 3.5L / FX45 2003-2008 6C 4.5L / G35 2003-2008 6C 3.5L / |  | CF10140      | <b>FRAM</b>     |
|   |  | CFI-999M     | <b>INTERFIL</b> |
|   |  | 24857        | <b>WIX</b>      |

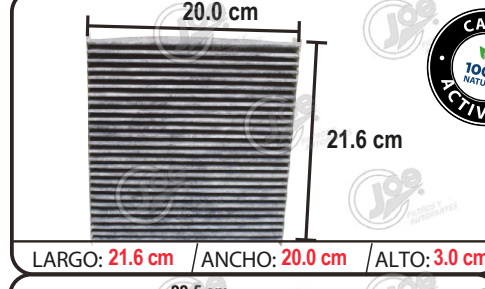

LARGO: 21.6 cm / ANCHO: 20.0 cm / ALTO: 3.0 cm

| INFINITI  |  | JAC999MCA    |                 |
|---|--|--------------|-----------------|
| APLICACIÓN  |  | EQUIVALENCIA |                 |
| FX35 2003-2008 6C 3.5L / FX45 2003-2008 6C 4.5L / G35 2003-2008 6C 3.5L / |  | CF10140      | <b>FRAM</b>     |
|   |  | CFI-999MCA   | <b>INTERFIL</b> |
|   |  | 24857        | <b>WIX</b>      |

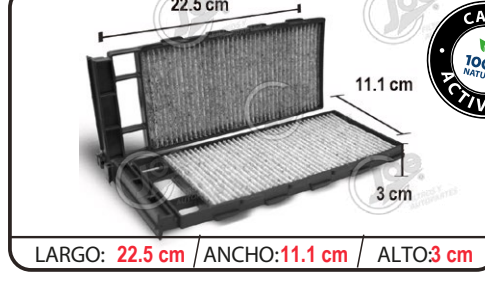

LARGO: 22.5 cm / ANCHO: 11.1 cm / ALTO: 3 cm

| INFINITI  |  | JAC2725CA    |                 |
|---|--|--------------|-----------------|
| APLICACIÓN                                      |  | EQUIVALENCIA |                 |
| G20 1999-2002 4C 2.0L / QX4 1998-2003 6C 3.3L / |  | CF10555      | <b>FRAM</b>     |
|   |  | CFI-2725     | <b>INTERFIL</b> |
|   |  | 24863        | <b>WIX</b>      |





| INFINITI                |  | JAC10388     |          |
|-------------------------|--|--------------|----------|
| APLICACIÓN              |  | EQUIVALENCIA |          |
| QX6 2004-2013 8C 5.6L / |  | CF10388      | FRAM     |
|                         |  | CFI-10388    | INTERFIL |
|                         |  | 24854        | WIX      |

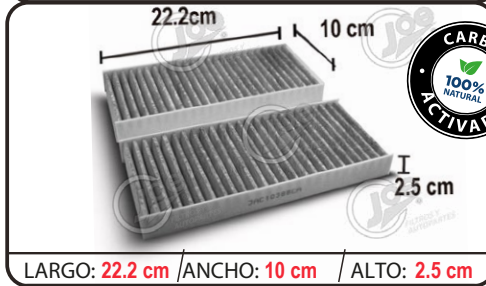

| INFINITI                |  | JAC10388CA   |          |
|-------------------------|--|--------------|----------|
| APLICACIÓN              |  | EQUIVALENCIA |          |
| QX6 2004-2013 8C 5.6L / |  | CF10388      | FRAM     |
|                         |  | CFI-10388    | INTERFIL |
|                         |  | 24854        | WIX      |



| JAGUAR   |  | JAC9465CA    |          |
|--|--|--------------|----------|
| APLICACIÓN                                       |  | EQUIVALENCIA |          |
| S-TYPE 2000 6C 3.0L / S-TYPE 2000-2002 6C 4.0L / |  | CF9465       | FRAM     |
|  |  | CFI-9465     | INTERFIL |
|  |  | 24884        | WIX      |

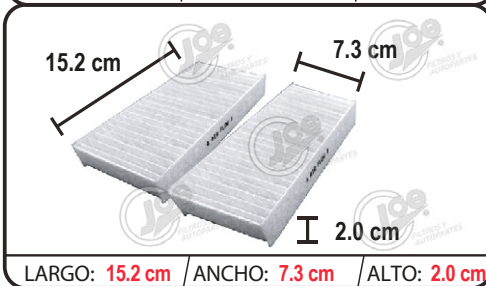

| JEEP   |  | JAC2430      |          |
|--|--|--------------|----------|
| APLICACIÓN   |  | EQUIVALENCIA |          |
| WRANGLER 2012-2019 6C 3.6L / WRANGLER 2011-6C 3.8L / |  | CF11777      | FRAM     |
|  |  | CFI-2430     | INTERFIL |
|  |  | 24302        | WIX      |



| JEEP   |  | JAC2430CA    |          |
|--|--|--------------|----------|
| APLICACIÓN   |  | EQUIVALENCIA |          |
| WRANGLER 2012-2019 6C 3.6L / WRANGLER 2011-6C 3.8L / |  | CF11777      | FRAM     |
|  |  | CFI-2430     | INTERFIL |
|  |  | 24302        | WIX      |

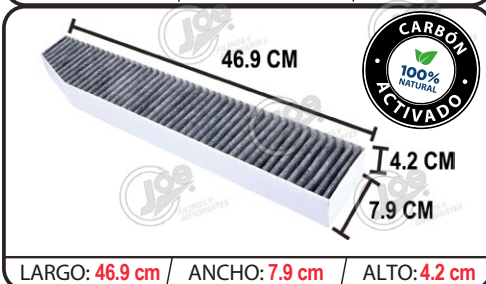

| JEEP  |  | JAC5013CA    |          |
|---|--|--------------|----------|
| APLICACIÓN  |  | EQUIVALENCIA |          |
| GRAND CHEROKEE 2005-2010 6C 3.7L / GRAND CHEROKEE 1999-2004 6C 4.0L / GRAND CHEROKEE 1999-2008 8C 4.7L / GRAND CHEROKEE 1993-1998 8C 5.2L / GRAND CHEROKEE 2005-2010 8C 5.7L / GRAND CHEROKEE 2006-2010 8C 6.1L / |  | CF10363      | FRAM     |
|   |  | CFI-5013     | INTERFIL |
|   |  | 24903        | WIX      |

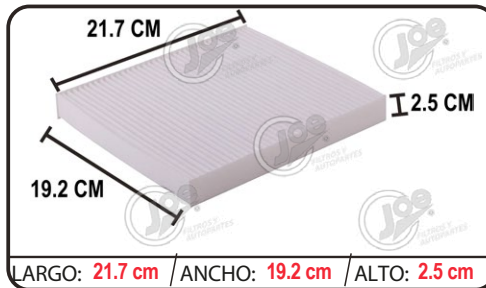

| JEEP  |  | JAC5058      |          |
|---|--|--------------|----------|
| APLICACIÓN  |  | EQUIVALENCIA |          |
| COMPASS 2007-2015 4C 2.5L / COMPASS 2007-2019 4C 2.4L / PATRIOT 2007-2015 4C 2.0L / PATRIOT 2007-2015 4C 2.4L / |  | CF10729      | FRAM     |
|   |  | CFI-5058     | INTERFIL |
|   |  | 24313        | WIX      |

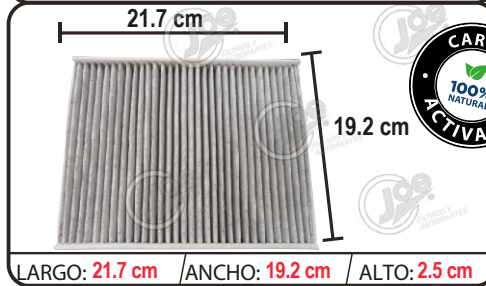

| JEEP  |  | JAC5058CA    |          |
|---|--|--------------|----------|
| APLICACIÓN  |  | EQUIVALENCIA |          |
| COMPASS 2007-2015 4C 2.5L / COMPASS 2007-2019 4C 2.4L / PATRIOT 2007-2015 4C 2.0L / PATRIOT 2007-2015 4C 2.4L / |  | CF10729      | FRAM     |
|   |  | CFI-5058CA   | INTERFIL |
|   |  | 24313        | WIX      |

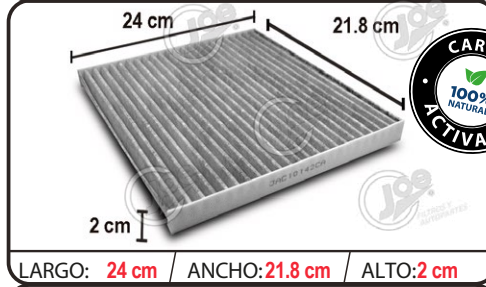

| JEEP  |  | JAC10142CA   |          |
|---|--|--------------|----------|
| APLICACIÓN  |  | EQUIVALENCIA |          |
| CHEROKEE 2015-2019 4C 2.4L / CHEROKEE 2015-2019 6C 3.2L / |  | N/D          | FRAM     |
|   |  | CFI-10142    | INTERFIL |
|   |  | WP10142      | WIX      |

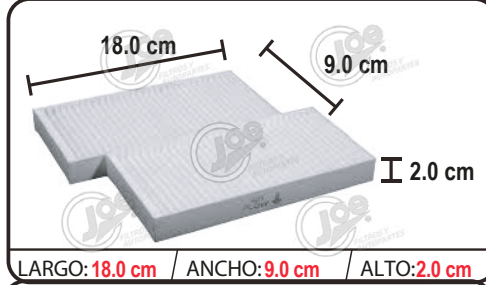

| JEEP                        |  | JAC10747     |          |
|-----------------------------|--|--------------|----------|
| APLICACIÓN                  |  | EQUIVALENCIA |          |
| LIBERTY 2008-2012 6C 3.7L / |  | CF10747      | FRAM     |
|                             |  | CFI-10747    | INTERFIL |
|                             |  | 49093        | WIX      |

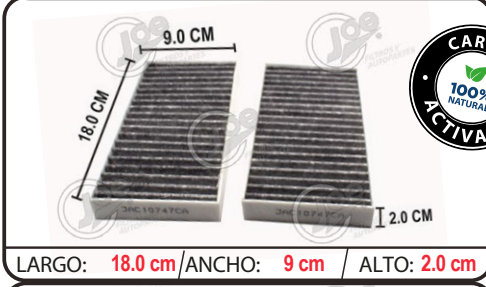

| JEEP                        |  | JAC10747CA   |          |
|-----------------------------|--|--------------|----------|
| APLICACIÓN                  |  | EQUIVALENCIA |          |
| LIBERTY 2008-2012 6C 3.7L / |  | CF10747      | FRAM     |
|                             |  | CFI-10747    | INTERFIL |
|                             |  | 49093        | WIX      |



| JEEP  |  | JAC11183     |          |
|---|--|--------------|----------|
| APLICACIÓN  |  | EQUIVALENCIA |          |
| GRAND CHEROKKE 2014-2015 6C 3.0L / GRAND CHEROKKE 2011-2019 6C 3.6L / GRAND CHEROKKE 2011-2019 8C 5.7L / GRAND CHEROKEE 2012-2017 8C 6.4L / |  | CF11183      | FRAM     |
|   |  | CFI-11183    | INTERFIL |
|   |  | 24017        | WIX      |



|  |   |  |         |             |           |                 |         |            |
|--|---|--|---------|-------------|-----------|-----------------|---------|------------|
|  <p>26.4 cm 24.7 cm 2.9 cm</p> <p>LARGO: 26.4 cm / ANCHO: 24.7 cm / ALTO: 2.9 cm</p>  | <p><b>JEEP</b></p> <p><b>APLICACIÓN</b></p> <p>GRAND CHEROKKE 2014-2015 6C 3.0L / GRAND CHEROKKE 2011-2019 6C 3.6L / GRAND CHEROKKE 2011-2019 8C 5.7L / GRAND CHEROKEE 2012-2017 8C 6.4L /</p>                            | <p><b>JAC11183CA</b></p> <p><b>EQUIVALENCIA</b></p> <table border="1"> <tr><td>CF11183</td><td><b>FRAM</b></td></tr> <tr><td>CFI-11183</td><td><b>INTERFIL</b></td></tr> <tr><td>24017</td><td><b>WIX</b></td></tr> </table> | CF11183 | <b>FRAM</b> | CFI-11183 | <b>INTERFIL</b> | 24017   | <b>WIX</b> |
| CF11183  | <b>FRAM</b>   |  |         |             |           |                 |         |            |
| CFI-11183  | <b>INTERFIL</b>   |  |         |             |           |                 |         |            |
| 24017  | <b>WIX</b>  |  |         |             |           |                 |         |            |
|  <p>22.5 CM 19.2 CM 2.9 CM</p> <p>LARGO: 22.5 cm / ANCHO: 19.27 cm / ALTO: 2.9 cm</p> | <p><b>KIA</b></p> <p><b>APLICACIÓN</b></p> <p>KIA CANDENZA 3.3 L. 2017-2020</p>   | <p><b>JAC1332</b></p> <p><b>EQUIVALENCIA</b></p> <table border="1"> <tr><td>N/D</td><td><b>FRAM</b></td></tr> <tr><td>CFI-1332</td><td><b>INTERFIL</b></td></tr> <tr><td>WP10155</td><td><b>WIX</b></td></tr> </table>       | N/D     | <b>FRAM</b> | CFI-1332  | <b>INTERFIL</b> | WP10155 | <b>WIX</b> |
| N/D  | <b>FRAM</b>   |  |         |             |           |                 |         |            |
| CFI-1332   | <b>INTERFIL</b>   |  |         |             |           |                 |         |            |
| WP10155  | <b>WIX</b>  |  |         |             |           |                 |         |            |
|  <p>31.7 CM 27.4 CM 4.5 CM</p> <p>LARGO: 31.7 cm / ANCHO: 27.4 cm / ALTO: 4.5 cm</p> | <p><b>KIA</b></p> <p><b>APLICACIÓN</b></p> <p>KIA CANDENZA 3.3 L. 2017-2020</p>   | <p><b>JAC1332CA</b></p> <p><b>EQUIVALENCIA</b></p> <table border="1"> <tr><td>N/D</td><td><b>FRAM</b></td></tr> <tr><td>CFI-1332</td><td><b>INTERFIL</b></td></tr> <tr><td>WP10155</td><td><b>WIX</b></td></tr> </table>     | N/D     | <b>FRAM</b> | CFI-1332  | <b>INTERFIL</b> | WP10155 | <b>WIX</b> |
| N/D  | <b>FRAM</b>   |  |         |             |           |                 |         |            |
| CFI-1332   | <b>INTERFIL</b>   |  |         |             |           |                 |         |            |
| WP10155  | <b>WIX</b>  |  |         |             |           |                 |         |            |
|  <p>24.8 cm 23.3 cm 3 cm</p> <p>LARGO: 24.8 cm / ANCHO: 23.3 cm / ALTO: 3.0 cm</p>  | <p><b>KIA</b></p> <p><b>APLICACIÓN</b></p> <p>OPTIMA 2016-2019 4C 2.4L /</p>  | <p><b>JAC2280CA</b></p> <p><b>EQUIVALENCIA</b></p> <table border="1"> <tr><td>N/D</td><td><b>FRAM</b></td></tr> <tr><td>CFI-2280</td><td><b>INTERFIL</b></td></tr> <tr><td>WP10129</td><td><b>WIX</b></td></tr> </table>     | N/D     | <b>FRAM</b> | CFI-2280  | <b>INTERFIL</b> | WP10129 | <b>WIX</b> |
| N/D  | <b>FRAM</b>   |  |         |             |           |                 |         |            |
| CFI-2280   | <b>INTERFIL</b>   |  |         |             |           |                 |         |            |
| WP10129  | <b>WIX</b>  |  |         |             |           |                 |         |            |
|  <p>19.6 cm 24 cm 2.0 cm</p> <p>LARGO: 24 cm / ANCHO: 19.6 cm / ALTO: 2.0 cm</p>    | <p><b>KIA</b></p> <p><b>APLICACIÓN</b></p> <p>FORTE 1.8 L 2014-2016 / FORTE 2.0 L 2014-2018<br/>MANN CU2331, MAHLE LK447, LA464,<br/>SKY SKI7133, UNIFIL FC-10728, NIKKO CFI17133MF<br/>OEM 087790-2H000, 97133-2H001</p> | <p><b>JAC7133</b></p> <p><b>EQUIVALENCIA</b></p> <table border="1"> <tr><td>CF11434</td><td><b>FRAM</b></td></tr> <tr><td>CFI7133</td><td><b>INTERFIL</b></td></tr> <tr><td>WP2046</td><td><b>WIX</b></td></tr> </table>     | CF11434 | <b>FRAM</b> | CFI7133   | <b>INTERFIL</b> | WP2046  | <b>WIX</b> |
| CF11434  | <b>FRAM</b>   |  |         |             |           |                 |         |            |
| CFI7133  | <b>INTERFIL</b>   |  |         |             |           |                 |         |            |
| WP2046   | <b>WIX</b>  |  |         |             |           |                 |         |            |
|  <p>19.6 cm 24 cm 2.0 cm</p> <p>LARGO: 24 cm / ANCHO: 19.6 cm / ALTO: 2.0 cm</p>    | <p><b>KIA</b></p> <p><b>APLICACIÓN</b></p> <p>FORTE 1.8 L 2014-2016 / FORTE 2.0 L 2014-2018<br/>MANN CU2331, MAHLE LK447, LA464,<br/>SKY SKI7133, UNIFIL FC-10728, NIKKO CFI17133MF<br/>OEM 087790-2H000, 97133-2H001</p> | <p><b>JAC7133CA</b></p> <p><b>EQUIVALENCIA</b></p> <table border="1"> <tr><td>CF11434</td><td><b>FRAM</b></td></tr> <tr><td>CFI7133</td><td><b>INTERFIL</b></td></tr> <tr><td>WP2046</td><td><b>WIX</b></td></tr> </table>   | CF11434 | <b>FRAM</b> | CFI7133   | <b>INTERFIL</b> | WP2046  | <b>WIX</b> |
| CF11434  | <b>FRAM</b>   |  |         |             |           |                 |         |            |
| CFI7133  | <b>INTERFIL</b>   |  |         |             |           |                 |         |            |
| WP2046   | <b>WIX</b>  |  |         |             |           |                 |         |            |

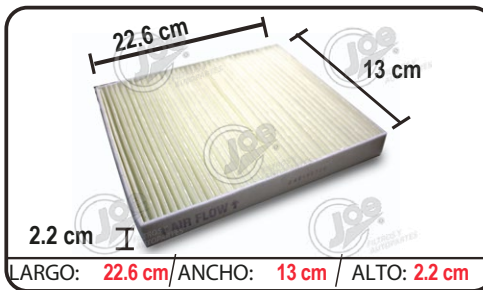

| KIA                        |  | JAC10329     |          |
|----------------------------|--|--------------|----------|
| APLICACIÓN                 |  | EQUIVALENCIA |          |
| SEDONA 2006-2010 6C 3.8L / |  | CF10329      | FRAM     |
|                            |  | N/D          | INTERFIL |
|                            |  | 24689        | WIX      |

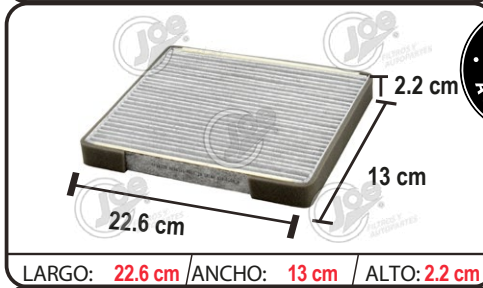

| KIA                        |  | JAC10329CA   |          |
|----------------------------|--|--------------|----------|
| APLICACIÓN                 |  | EQUIVALENCIA |          |
| SEDONA 2006-2010 6C 3.8L / |  | CF10329      | FRAM     |
|                            |  | N/D          | INTERFIL |
|                            |  | 24689        | WIX      |

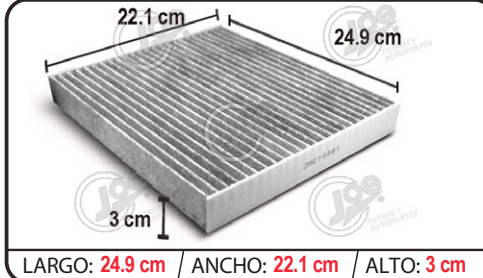

| KIA   |  | JAC10381     |          |
|---|--|--------------|----------|
| APLICACIÓN  |  | EQUIVALENCIA |          |
| MAGENTIS 2006-2010 4C 2.4L / MAGENTIS 2006-2010 6C 2.7L / OPTIMA 2006-2010 4C 2.4L / OPTIMA 2006-2010 6C 2.7L / |  | CF10381      | FRAM     |
|   |  | N/D          | INTERFIL |
|   |  | 24517        | WIX      |

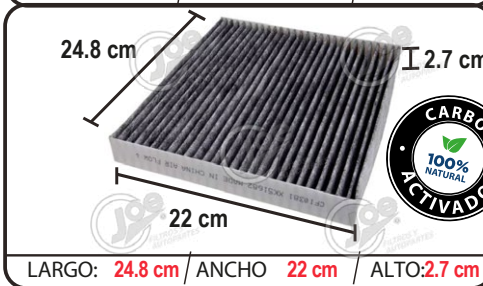

| KIA   |  | JAC10381CA   |          |
|---|--|--------------|----------|
| APLICACIÓN  |  | EQUIVALENCIA |          |
| MAGENTIS 2006-2010 4C 2.4L / MAGENTIS 2006-2010 6C 2.7L / OPTIMA 2006-2010 4C 2.4L / OPTIMA 2006-2010 6C 2.7L / |  | CF10381      | FRAM     |
|   |  | N/D          | INTERFIL |
|   |  | 24517        | WIX      |

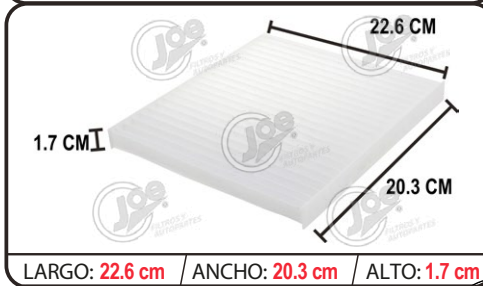

| KIA  |  | JAC10709     |          |
|--|--|--------------|----------|
| APLICACIÓN   |  | EQUIVALENCIA |          |
| FORTE 2010-2013 4C 2.0L / FORTE 2010-2013 4C 2.4L / FORTE 5 2012-2013 4C 2.0L / FORTE KOUP 2010-2013 4C 2.0L / FORTE KOUP 2010-2013 4C 2.4L / RIO 2006-2017 4C 1.6L / RIO 5 2006-2011 4C 1.6L / RONDO 2007-2012 4C 2.4L / RONDO 2007-2012 6C 2.7L / SPORTAGE 2005-2016 4C 2.0L / SPORTAGE 2011-2016 4C 2.4L / SPORTAGE 2005-2010 6C 2.7L / |  | CF10709      | FRAM     |
|  |  | N/D          | INTERFIL |
|  |  | 24684        | WIX      |

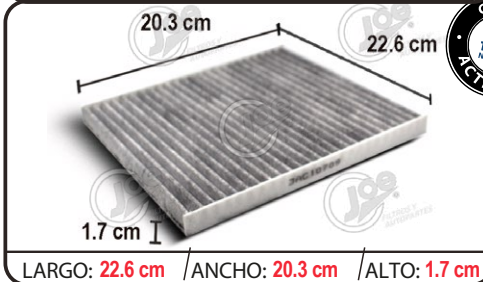

| KIA  |  | JAC10709CA   |          |
|--|--|--------------|----------|
| APLICACIÓN   |  | EQUIVALENCIA |          |
| FORTE 2010-2013 4C 2.0L / FORTE 2010-2013 4C 2.4L / FORTE 5 2012-2013 4C 2.0L / FORTE KOUP 2010-2013 4C 2.0L / FORTE KOUP 2010-2013 4C 2.4L / RIO 2006-2017 4C 1.6L / RIO 5 2006-2011 4C 1.6L / RONDO 2007-2012 4C 2.4L / RONDO 2007-2012 6C 2.7L / SPORTAGE 2005-2016 4C 2.0L / SPORTAGE 2011-2016 4C 2.4L / SPORTAGE 2005-2010 6C 2.7L / |  | CF10709      | FRAM     |
|  |  | N/D          | INTERFIL |
|  |  | 24684        | WIX      |

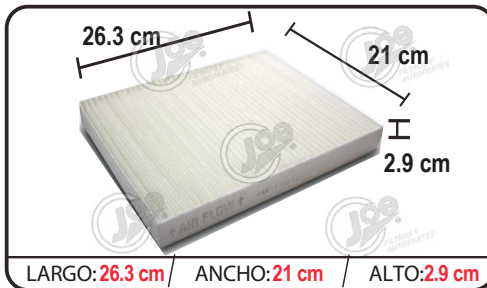

| KIA   |  | JAC11664     |                 |
|---|--|--------------|-----------------|
| APLICACIÓN  |  | EQUIVALENCIA |                 |
| SORENTO 2011-2015 4C 2.4L / SORENTO 2014-2015 6C 3.3L / SORENTO 2011-2013 6C 3.5L / |  | CF11664      | <b>FRAM</b>     |
|   |  | N/D          | <b>INTERFIL</b> |
|   |  | 24080        | <b>WIX</b>      |



| KIA   |  | JAC11664CA   |                 |
|---|--|--------------|-----------------|
| APLICACIÓN  |  | EQUIVALENCIA |                 |
| SORENTO 2011-2015 4C 2.4L / SORENTO 2014-2015 6C 3.3L / SORENTO 2011-2013 6C 3.5L / |  | CF11664      | <b>FRAM</b>     |
|   |  | N/D          | <b>INTERFIL</b> |
|   |  | 24080        | <b>WIX</b>      |

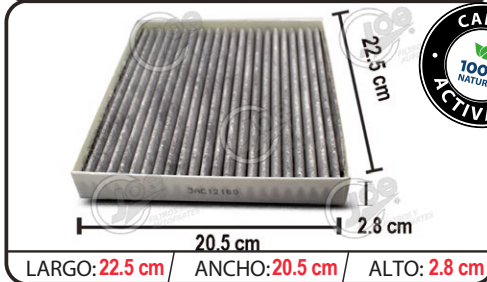

| KIA   |  | JAC12160CA   |                 |
|---|--|--------------|-----------------|
| APLICACIÓN  |  | EQUIVALENCIA |                 |
| KIA SELTOS SOUL, SPORTAGE, 4 CIL 1.6, 2.0, 2.4 L. 2017-2022 |  | N/D          | <b>FRAM</b>     |
|   |  | N/D          | <b>INTERFIL</b> |
|   |  | N/D          | <b>WIX</b>      |

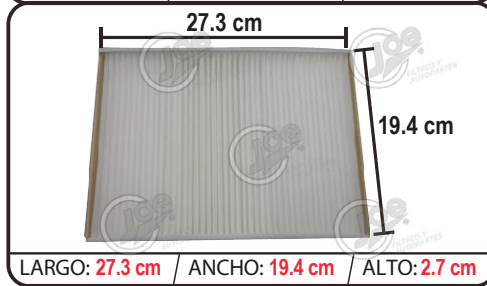

| LAND ROVER  |  | JAC1805      |                 |
|---|--|--------------|-----------------|
| APLICACIÓN  |  | EQUIVALENCIA |                 |
| FREELANDER 2007-2010 6C 2.2L / LR2 2013-2015 4C 2.0L / LR2 2008-2012 6C 3.2L / RANGE ROVER EVOQUE 2012-2015 4C 2.0L TURBO / |  | CF10442      | <b>FRAM</b>     |
|   |  | CFI-1805     | <b>INTERFIL</b> |
|   |  | 49355        | <b>WIX</b>      |



| LAND ROVER  |  | JAC1805CA    |                 |
|---|--|--------------|-----------------|
| APLICACIÓN  |  | EQUIVALENCIA |                 |
| FREELANDER 2007-2010 6C 2.2L / LR2 2013-2015 4C 2.0L / LR2 2008-2012 6C 3.2L / RANGE ROVER EVOQUE 2012-2015 4C 2.0L TURBO / |  | CF10442      | <b>FRAM</b>     |
|   |  | CFI-1805CA   | <b>INTERFIL</b> |
|   |  | 49355        | <b>WIX</b>      |

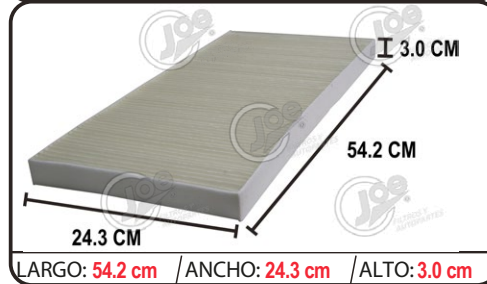

| LAND ROVER  |  | JAC9044      |                 |
|---|--|--------------|-----------------|
| APLICACIÓN  |  | EQUIVALENCIA |                 |
| RANGE ROVER 2006-2009 8C 4.2L / RANGE ROVER 2003-2009 8C 4.4L / RANGE ROVER 2002-2005 8C 4.5L / RANGE ROVER 2010-2011 8C 5.0L / |  | CF10830      | <b>FRAM</b>     |
|   |  | CFI-9044     | <b>INTERFIL</b> |
|   |  | 24827        | <b>WIX</b>      |

|  |   |  |  |  |
|--|---|--|--|--|
|  <p>54.2 cm<br/>25.5 cm</p> <p><b>CARBÓN ACTIVADO</b><br/>100% NATURAL</p> | <b>LAND ROVER</b>   |  | <b>JAC9044CA</b>   |  |
|  | <b>APLICACIÓN</b><br>RANGE ROVER 2006-2009 8C 4.2L / RANGE ROVER 2003-2009 8C 4.4L / RANGE ROVER 2002- 2005 8C 4.5L / RANGE ROVER 2010-2011 8C 5.0L / |  | <b>EQUIVALENCIA</b><br>CF10830 <b>FRAM</b><br>CFI-9044CA <b>INTERFIL</b><br>24827 <b>WIX</b> |  |
| LARGO: 54.2 cm / ANCHO: 25.5 cm / ALTO: 3.0 cm   |   |  |  |  |

|  |   |  |  |  |
|--|---|--|--|--|
|  <p>21.5 cm<br/>21.4 cm<br/>1.7 cm</p> | <b>LEXUS</b>  |  | <b>JAC4701</b>   |  |
|  | <b>APLICACIÓN</b><br>GX470 2006-2009 8C 4.7L / RX350 2007-2009 6C 3.5 / RX400H HIBRIDO 2006-2009 6C 3.5L / S330 2004-2006 6C 3.3L / |  | <b>EQUIVALENCIA</b><br>CF9846A <b>FRAM</b><br>CFI-4701 <b>INTERFIL</b><br>24875 <b>WIX</b> |  |
| LARGO: 21.5 cm / ANCHO: 21.4 cm / ALTO: 1.7 cm   |   |  |  |  |

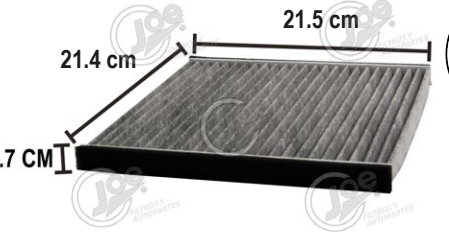
|  |   |  |  |  |
|--|---|--|--|--|
|  <p>21.5 cm<br/>21.4 cm<br/>1.7 cm</p> <p><b>CARBÓN ACTIVADO</b><br/>100% NATURAL</p> | <b>LEXUS</b>  |  | <b>JAC4701CA</b>   |  |
|  | <b>APLICACIÓN</b><br>GX470 2006-2009 8C 4.7L / RX350 2007-2009 6C 3.5 / RX400H HIBRIDO 2006-2009 6C 3.5L / S330 2004-2006 6C 3.3L / |  | <b>EQUIVALENCIA</b><br>CF9846A <b>FRAM</b><br>CFI-4701 <b>INTERFIL</b><br>24875 <b>WIX</b> |  |
| LARGO: 21.5 cm / ANCHO: 21.4 cm / ALTO: 1.7 cm   |   |  |  |  |

|  |   |  |  |  |
|--|---|--|--|--|
|  <p>21.3 cm<br/>22.2 cm<br/>2 cm</p> | <b>LEXUS</b>  |  | <b>JAC8713</b>   |  |
|  | <b>APLICACIÓN</b><br>ES330 2004-2006 6C 3.3L / GX470 2006-2009 8C 4.7L / RX350 2007-2009 6C 3.5L / RX400H HIBRIDO 2006-2008 6C 3.3L / |  | <b>EQUIVALENCIA</b><br>CF10132 <b>FRAM</b><br>CFI-8713 <b>INTERFIL</b><br>24883 <b>WIX</b> |  |
| LARGO: 22.2 cm / ANCHO: 21.3 cm / ALTO: 2 cm   |   |  |  |  |

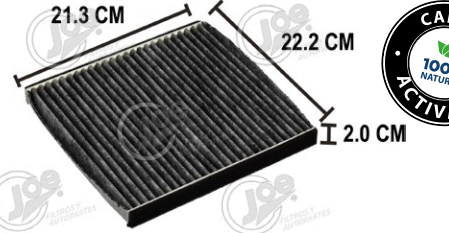
|   |   |  |  |  |
|---|---|--|--|--|
|  <p>21.3 cm<br/>22.2 cm<br/>2.0 cm</p> <p><b>CARBÓN ACTIVADO</b><br/>100% NATURAL</p> | <b>LEXUS</b>  |  | <b>JAC8713CA</b>   |  |
|   | <b>APLICACIÓN</b><br>ES330 2004-2006 6C 3.3L / GX470 2006-2009 8C 4.7L / RX350 2007-2009 6C 3.5L / RX400H HIBRIDO 2006-2008 6C 3.3L / |  | <b>EQUIVALENCIA</b><br>CF10132 <b>FRAM</b><br>CFI-8713 <b>INTERFIL</b><br>24883 <b>WIX</b> |  |
| LARGO: 22.2 cm / ANCHO: 21.3 cm / ALTO: 2 cm  |   |  |  |  |

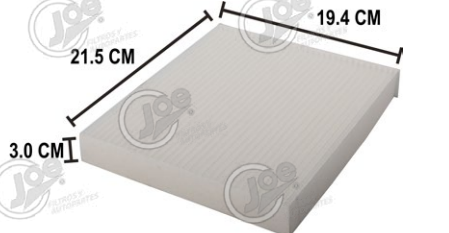
|  |   |  |  |  |
|--|---|--|--|--|
|  <p>21.5 cm<br/>19.4 cm<br/>3.0 cm</p> | <b>LEXUS</b>  |  | <b>JAC8719</b>   |  |
|  | <b>APLICACIÓN</b><br>ES350 2007-2014 6C 3.5L / GS350 2007-2011 6C 3.5L / GX460 2010-2014 8C 4.6L / LX570 2008-2013 8C 4.6L / RX350 2010-2015 6C 3.5L / RX450H HIBRIDO 2010-2015 6C 3.5L / |  | <b>EQUIVALENCIA</b><br>CF10285 <b>FRAM</b><br>CFI-8719CA <b>INTERFIL</b><br>24488 / 24483 <b>WIX</b> |  |
| LARGO: 21.5 cm / ANCHO: 19.4 cm / ALTO: 3.0 cm   |   |  |  |  |





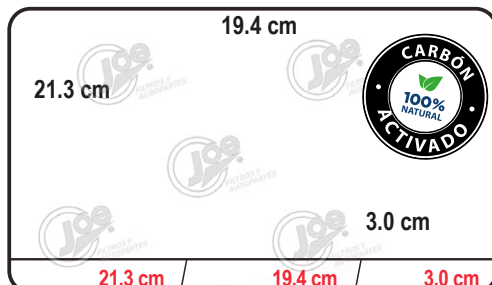

| LEXUS  |  | JAC8719CA     |                 |
|--|--|---------------|-----------------|
| APLICACIÓN   |  | EQUIVALENCIA  |                 |
| ES350 2007-2014 6C 3.5L / GS350 2007-2011 6C 3.5L / GX460 2010-2014 8C 4.6L / LX570 2008-2013 8C 4.6L / RX350 2010-2015 6C 3.5L / RX450H HIBRIDO 2010-2015 6C 3.5L / |  | CF10285       | <b>FRAM</b>     |
|  |  | CFI-8719CA    | <b>INTERFIL</b> |
|  |  | 24488 / 24483 | <b>WIX</b>      |



| LEXUS  |  | JAC10157     |                 |
|--|--|--------------|-----------------|
| APLICACIÓN   |  | EQUIVALENCIA |                 |
| ES330 2002-2003 6C 3.0L / ES330 2004-2006 6C 3.3L / GX470 2003-2006 8C 4.7L / RX330 2004- 2006 6C 3.3L / |  | CF10157      | <b>FRAM</b>     |
|  |  | N/D          | <b>INTERFIL</b> |
|  |  | 24905        | <b>WIX</b>      |

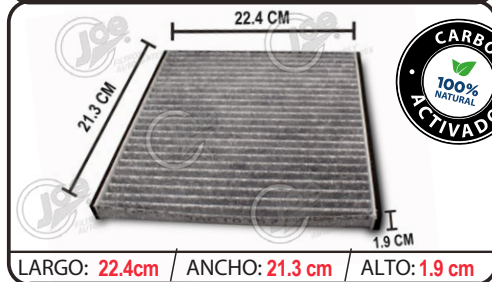

| LEXUS  |  | JAC10157CA   |                 |
|--|--|--------------|-----------------|
| APLICACIÓN   |  | EQUIVALENCIA |                 |
| ES330 2002-2003 6C 3.0L / ES330 2004-2006 6C 3.3L / GX470 2003-2006 8C 4.7L / RX330 2004- 2006 6C 3.3L / |  | CF10157      | <b>FRAM</b>     |
|  |  | N/D          | <b>INTERFIL</b> |
|  |  | 24905        | <b>WIX</b>      |

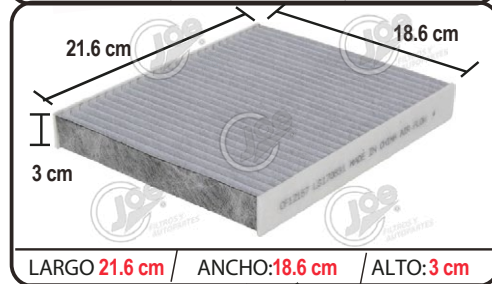

| LEXUS   |  | JAC12157     |                 |
|---|--|--------------|-----------------|
| APLICACIÓN  |  | EQUIVALENCIA |                 |
| ES250 (2021-2022), ES300H (2019-2021), ES350 (2019-2021), RX350 (2016-2021), RX350L (2018-2021), RX450H (2016-2021), RX450HL (2018-2021), UX200 (2019-2021), UX250H (2019-2021) |  | CF12157      | <b>FRAM</b>     |
|   |  |              | <b>INTERFIL</b> |
|   |  | WP10322      | <b>WIX</b>      |

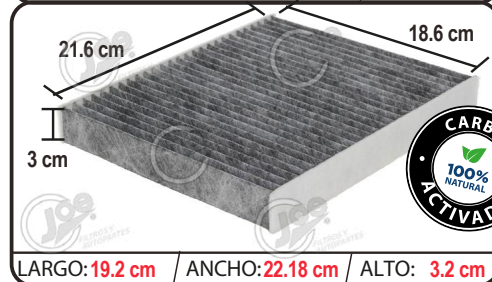

| LEXUS                             |  | JAC12157CA   |                 |
|-----------------------------------|--|--------------|-----------------|
| APLICACIÓN                        |  | EQUIVALENCIA |                 |
| RX350 - 450 6 CIL, 3.5L 2016-2022 |  | CF12157      | <b>FRAM</b>     |
|                                   |  | CFI-12157CA  | <b>INTERFIL</b> |
|                                   |  | WP10322      | <b>WIX</b>      |

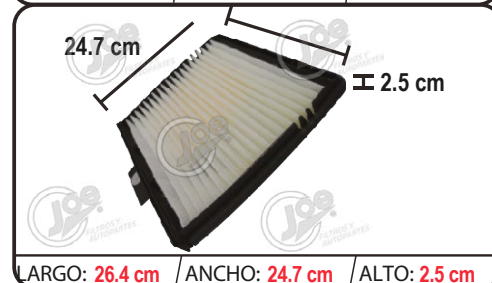

| LINCOLN  |  | JAC19N6      |                 |
|--|--|--------------|-----------------|
| APLICACIÓN   |  | EQUIVALENCIA |                 |
| BLACKWOOD 2002-2005 8C 5.4L / NAVIGATOR 2003 8C 4.6L / NAVIGATOR 1998-2002 8C 5.4L / |  | CF8631       | <b>FRAM</b>     |
|  |  | CFI-19N6     | <b>INTERFIL</b> |
|  |  | 24876        | <b>WIX</b>      |

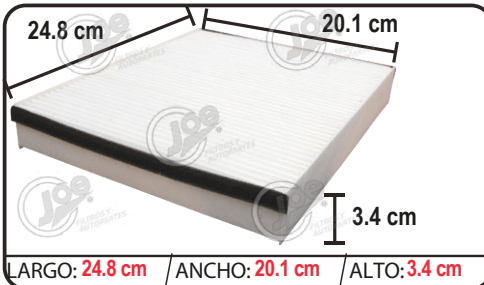

| LINCOLN                 |  | JAC6Z19      |          |
|-------------------------|--|--------------|----------|
| APLICACIÓN              |  | EQUIVALENCIA |          |
| MKC 2015-2019 4C 2.0L / |  | CF920        | FRAM     |
|                         |  | N/D          | INTERFIL |
|                         |  | 24419        | WIX      |

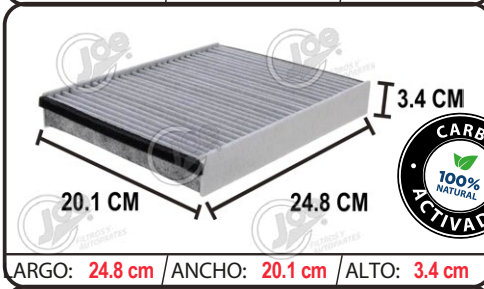

| LINCOLN                 |  | JAC6Z19CA    |          |
|-------------------------|--|--------------|----------|
| APLICACIÓN              |  | EQUIVALENCIA |          |
| MKC 2015-2019 4C 2.0L / |  | CF920        | FRAM     |
|                         |  | N/D          | INTERFIL |
|                         |  | 24419        | WIX      |

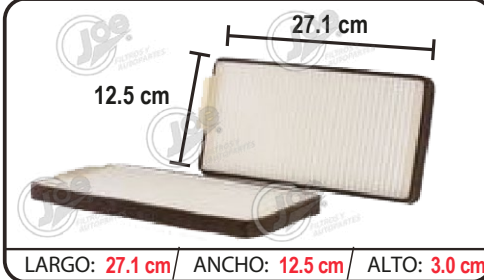

| LINCOLN                         |  | JAC8045      |          |
|---------------------------------|--|--------------|----------|
| APLICACIÓN                      |  | EQUIVALENCIA |          |
| CONTINENTAL 1995-1997 8C 4.6L / |  | CF8045A      | FRAM     |
|                                 |  | CFI-10547    | INTERFIL |
|                                 |  | 24772        | WIX      |

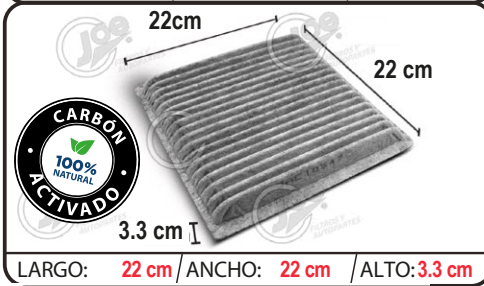

| LINCOLN   |  | JAC10547CA   |          |
|---|--|--------------|----------|
| APLICACIÓN                                      |  | EQUIVALENCIA |          |
| MKX 2007-2010 6C 3.5L / MKX 2011-2015 6C 3.7L / |  | CF10547      | FRAM     |
|   |  | N/D          | INTERFIL |
|   |  | 24065        | WIX      |

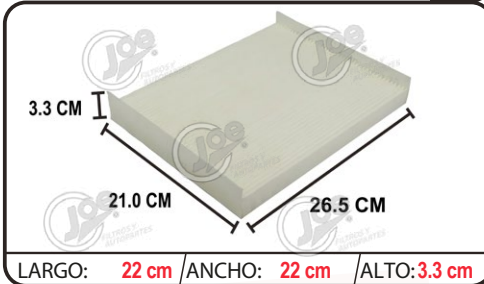

| LINCOLN  |  | JAC11174     |          |
|--|--|--------------|----------|
| APLICACIÓN   |  | EQUIVALENCIA |          |
| MKZ 2011-2012 4C 2.5L / MKZ 2010-2012 6C 3.5L / MKZ 2013 6C 3.7L / |  | CF11174      | FRAM     |
|  |  | N/D          | INTERFIL |
|  |  | 24367        | WIX      |

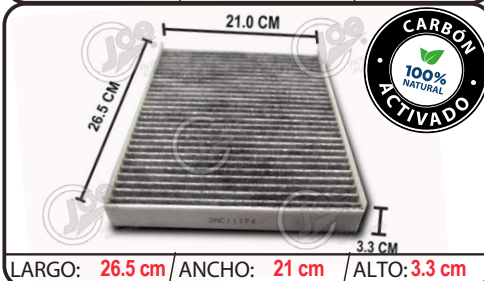

| LINCOLN  |  | JAC11174CA   |          |
|--|--|--------------|----------|
| APLICACIÓN   |  | EQUIVALENCIA |          |
| MKZ 2011-2012 4C 2.5L / MKZ 2010-2012 6C 3.5L / MKZ 2013 6C 3.7L / |  | CF11174      | FRAM     |
|  |  | N/D          | INTERFIL |
|  |  | 24367        | WIX      |

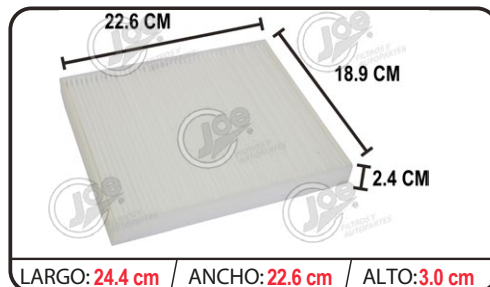

| LINCOLN   |  | JAC11176     |                 |
|---|--|--------------|-----------------|
| APLICACIÓN                                      |  | EQUIVALENCIA |                 |
| MKX 2007-2010 6C 3.5L / MKX 2011-2015 6C 3.7L / |  | CF11176      | <b>FRAM</b>     |
|   |  | N/D          | <b>INTERFIL</b> |
|   |  | 24068        | <b>WIX</b>      |

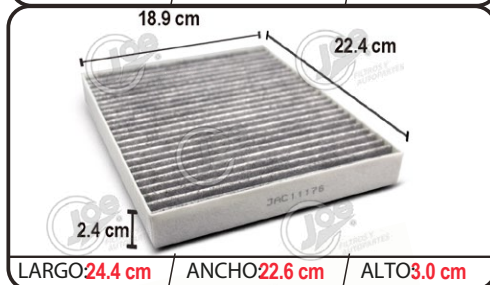

| LINCOLN   |  | JAC11176CA   |                 |
|---|--|--------------|-----------------|
| APLICACIÓN                                      |  | EQUIVALENCIA |                 |
| MKX 2007-2010 6C 3.5L / MKX 2011-2015 6C 3.7L / |  | CF11176      | <b>FRAM</b>     |
|   |  | CFI-11176    | <b>INTERFIL</b> |
|   |  | 24068        | <b>WIX</b>      |

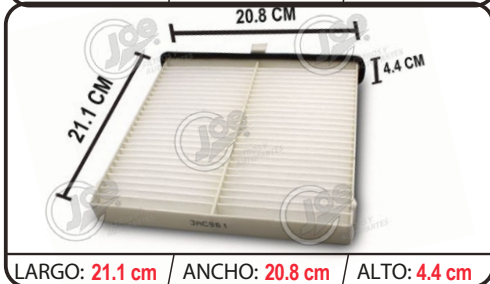

| MAZDA                                 |  | JAC961       |                 |
|---------------------------------------|--|--------------|-----------------|
| APLICACIÓN                            |  | EQUIVALENCIA |                 |
| CX-3 2.0 LTS. 4 CIL. MOD. 2011-2017 / |  | N/D          | <b>FRAM</b>     |
|                                       |  | N/D          | <b>INTERFIL</b> |
|                                       |  | N/D          | <b>WIX</b>      |



| MAZDA  |  | JAC2410      |                 |
|--|--|--------------|-----------------|
| APLICACIÓN   |  | EQUIVALENCIA |                 |
| CX-5 2013-2018 4C 2.0L / 3 2013-2018 4C 2.0L / 3 2013-2018 4C 2.5L / 5 2013-2017 4C 2.5L / |  | CF11811      | <b>FRAM</b>     |
|  |  | CFI-2410     | <b>INTERFIL</b> |
|  |  | 24103        | <b>WIX</b>      |

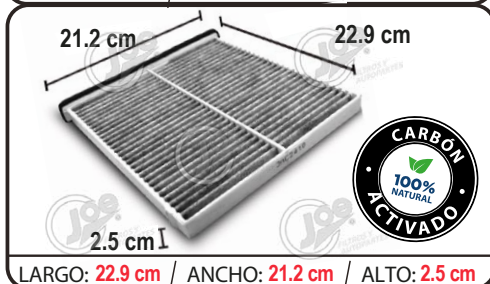

| MAZDA  |  | JAC2410CA    |                 |
|--|--|--------------|-----------------|
| APLICACIÓN   |  | EQUIVALENCIA |                 |
| CX-5 2013-2018 4C 2.0L / 3 2013-2018 4C 2.0L / 3 2013-2018 4C 2.5L / 5 2013-2017 4C 2.5L / |  | CF11811      | <b>FRAM</b>     |
|  |  | CFI-2410     | <b>INTERFIL</b> |
|  |  | 24103        | <b>WIX</b>      |

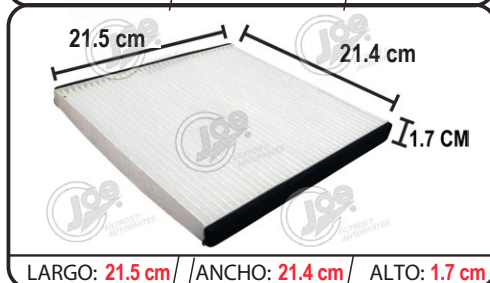

| MAZDA                   |  | JAC4701      |                 |
|-------------------------|--|--------------|-----------------|
| APLICACIÓN              |  | EQUIVALENCIA |                 |
| MPV 2000-2003 6C 2.5L / |  | CF9846A      | <b>FRAM</b>     |
|                         |  | CFI-4701     | <b>INTERFIL</b> |
|                         |  | 24875        | <b>WIX</b>      |

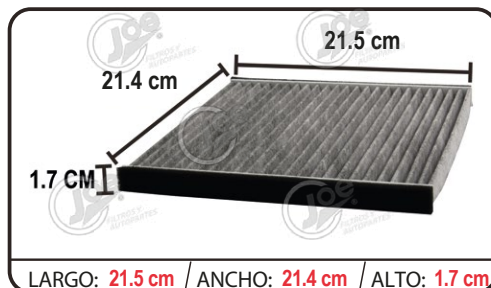

| MAZDA                   | JAC4701CA                |
|-------------------------|--------------------------|
| APLICACIÓN              | EQUIVALENCIA             |
| MPV 2000-2003 6C 2.5L / | CF9846A <b>FRAM</b>      |
|                         | CFI-4701 <b>INTERFIL</b> |
|                         | <b>WIX</b>               |

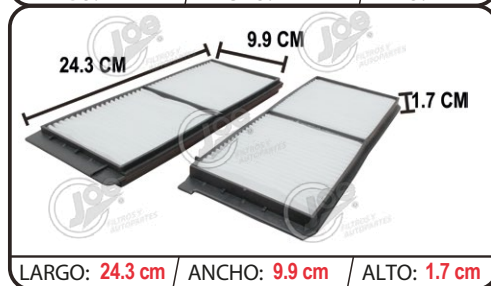

| MAZDA                 | JAC6516                  |
|-----------------------|--------------------------|
| APLICACIÓN            | EQUIVALENCIA             |
| 2 2011-2017 4C 1.5L / | N/D <b>FRAM</b>          |
|                       | CFI-6516 <b>INTERFIL</b> |
|                       | <b>WIX</b>               |

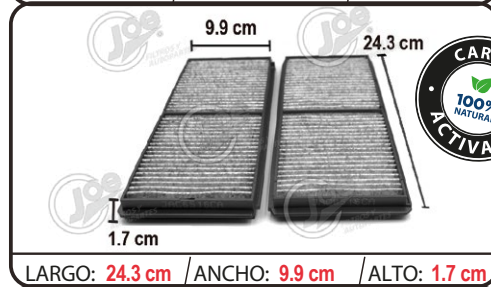

| MAZDA                 | JAC6516CA                |
|-----------------------|--------------------------|
| APLICACIÓN            | EQUIVALENCIA             |
| 2 2011-2017 4C 1.5L / | N/D <b>FRAM</b>          |
|                       | CFI-6516 <b>INTERFIL</b> |
|                       | 24036 <b>WIX</b>         |

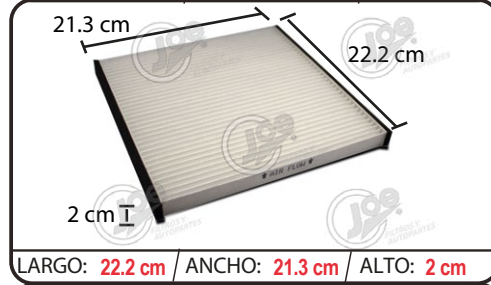

| MAZDA                   | JAC8713                  |
|-------------------------|--------------------------|
| APLICACIÓN              | EQUIVALENCIA             |
| MPV 2000-2003 6C 2.5L / | CF10132 <b>FRAM</b>      |
|                         | CFI-8713 <b>INTERFIL</b> |
|                         | 24883 <b>WIX</b>         |



| MAZDA                   | JAC8713CA                |
|-------------------------|--------------------------|
| APLICACIÓN              | EQUIVALENCIA             |
| MPV 2000-2003 6C 2.5L / | CF10132 <b>FRAM</b>      |
|                         | CFI-8713 <b>INTERFIL</b> |
|                         | 24883 <b>WIX</b>         |

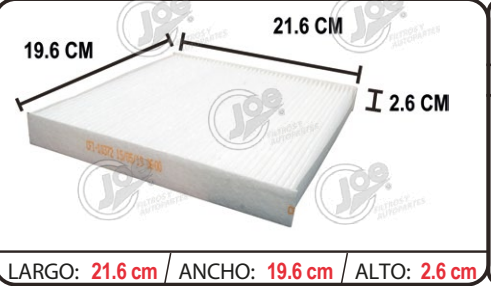

| MAZDA   | JAC10372                  |
|---|---------------------------|
| APLICACIÓN  | EQUIVALENCIA              |
| 6 2003-2008 4C 2.3L / 6 2007 4C 2.3L TURBO / 62003-2008 6C 3.0L / | CF10372 <b>FRAM</b>       |
|   | CFI-10372 <b>INTERFIL</b> |
|   | 24907 <b>WIX</b>          |

|  |   |   |         |             |             |                 |         |            |
|--|---|---|---------|-------------|-------------|-----------------|---------|------------|
|  <p>22 cm<br/>22 cm<br/>3.3 cm</p> <p>LARGO: 22 cm / ANCHO: 22 cm / ALTO: 3.3 cm</p>          | <p><b>MAZDA</b></p> <p>APLICACIÓN</p> <p>CX-9 2007-2017 6C 3.7L /</p>                     | <p><b>JAC10547CA</b></p> <p>EQUIVALENCIA</p> <table border="1"> <tr><td>CF10547</td><td><b>FRAM</b></td></tr> <tr><td>CFI-10547</td><td><b>INTERFIL</b></td></tr> <tr><td>24065</td><td><b>WIX</b></td></tr> </table>     | CF10547 | <b>FRAM</b> | CFI-10547   | <b>INTERFIL</b> | 24065   | <b>WIX</b> |
| CF10547  | <b>FRAM</b>   |   |         |             |             |                 |         |            |
| CFI-10547  | <b>INTERFIL</b>   |   |         |             |             |                 |         |            |
| 24065  | <b>WIX</b>  |   |         |             |             |                 |         |            |
|  <p>22.6 cm<br/>24.4 cm</p> <p>LARGO: 24.4 cm / ANCHO: 22.6 cm / ALTO: 3 cm</p>               | <p><b>MAZDA</b></p> <p>APLICACIÓN</p> <p>CX-9 2007 6C 3.5L / CX-9 2008-2017 6C 3.7L /</p> | <p><b>JAC11176</b></p> <p>EQUIVALENCIA</p> <table border="1"> <tr><td>CF11176</td><td><b>FRAM</b></td></tr> <tr><td></td><td><b>INTERFIL</b></td></tr> <tr><td>24068</td><td><b>WIX</b></td></tr> </table>                | CF11176 | <b>FRAM</b> |             | <b>INTERFIL</b> | 24068   | <b>WIX</b> |
| CF11176  | <b>FRAM</b>   |   |         |             |             |                 |         |            |
|  | <b>INTERFIL</b>   |   |         |             |             |                 |         |            |
| 24068  | <b>WIX</b>  |   |         |             |             |                 |         |            |
|  <p>18.9 cm<br/>22.4 cm<br/>2.4 cm</p> <p>LARGO: 24.4 cm / ANCHO: 22.6 cm / ALTO: 3.0 cm</p> | <p><b>MAZDA</b></p> <p>APLICACIÓN</p> <p>CX-9 2007 6C 3.5L / CX-9 2008-2017 6C 3.7L /</p> | <p><b>JAC11176CA</b></p> <p>EQUIVALENCIA</p> <table border="1"> <tr><td>CF11176</td><td><b>FRAM</b></td></tr> <tr><td>CFI-11176</td><td><b>INTERFIL</b></td></tr> <tr><td></td><td><b>WIX</b></td></tr> </table>          | CF11176 | <b>FRAM</b> | CFI-11176   | <b>INTERFIL</b> |         | <b>WIX</b> |
| CF11176  | <b>FRAM</b>   |   |         |             |             |                 |         |            |
| CFI-11176  | <b>INTERFIL</b>   |   |         |             |             |                 |         |            |
|  | <b>WIX</b>  |   |         |             |             |                 |         |            |
|  <p>21.5 cm<br/>23.4 cm<br/>3 cm</p> <p>LARGO: 23.4 cm / ANCHO: 21.5 cm / ALTO: 3 cm</p>    | <p><b>MAZDA</b></p> <p>APLICACIÓN</p> <p>MAZDA 3 HATCHBACK 6, CX-5 Y SERIE B</p>          | <p><b>JAC11548CA</b></p> <p>EQUIVALENCIA</p> <table border="1"> <tr><td>N/D</td><td><b>FRAM</b></td></tr> <tr><td>N/D</td><td><b>INTERFIL</b></td></tr> <tr><td>N/D</td><td><b>WIX</b></td></tr> </table>                 | N/D     | <b>FRAM</b> | N/D         | <b>INTERFIL</b> | N/D     | <b>WIX</b> |
| N/D  | <b>FRAM</b>   |   |         |             |             |                 |         |            |
| N/D  | <b>INTERFIL</b>   |   |         |             |             |                 |         |            |
| N/D  | <b>WIX</b>  |   |         |             |             |                 |         |            |
|  <p>21.6 cm<br/>18.6 cm<br/>3 cm</p> <p>LARGO 21.6 cm / ANCHO:18.6 cm / ALTO: 3 cm</p>      | <p><b>MAZDA</b></p> <p>APLICACIÓN</p> <p>CX-9 (2016-2021)</p>                             | <p><b>JAC12157</b></p> <p>EQUIVALENCIA</p> <table border="1"> <tr><td>CF12157</td><td><b>FRAM</b></td></tr> <tr><td></td><td><b>INTERFIL</b></td></tr> <tr><td>WP10322</td><td><b>WIX</b></td></tr> </table>              | CF12157 | <b>FRAM</b> |             | <b>INTERFIL</b> | WP10322 | <b>WIX</b> |
| CF12157  | <b>FRAM</b>   |   |         |             |             |                 |         |            |
|  | <b>INTERFIL</b>   |   |         |             |             |                 |         |            |
| WP10322  | <b>WIX</b>  |   |         |             |             |                 |         |            |
|  <p>21.6 cm<br/>18.6 cm<br/>3 cm</p> <p>LARGO 21.6 cm / ANCHO:18.6 cm / ALTO: 3 cm</p>      | <p><b>MAZDA</b></p> <p>APLICACIÓN</p> <p>CX-9 4 CIL. 2.5L 2016 – 2022</p>                 | <p><b>JAC12157CA</b></p> <p>EQUIVALENCIA</p> <table border="1"> <tr><td>CF12157</td><td><b>FRAM</b></td></tr> <tr><td>CFI-12157CA</td><td><b>INTERFIL</b></td></tr> <tr><td>WP10322</td><td><b>WIX</b></td></tr> </table> | CF12157 | <b>FRAM</b> | CFI-12157CA | <b>INTERFIL</b> | WP10322 | <b>WIX</b> |
| CF12157  | <b>FRAM</b>   |   |         |             |             |                 |         |            |
| CFI-12157CA  | <b>INTERFIL</b>   |   |         |             |             |                 |         |            |
| WP10322  | <b>WIX</b>  |   |         |             |             |                 |         |            |



| MAZDA   | JAC8L8Z                  |
|---|--------------------------|
| APLICACIÓN  | EQUIVALENCIA             |
| TRIBUTE 2009-2012 4C 2.5L / TRIBUTE 2008-2011 6C 3.0L / TRIBUTE HIBRIDO 2008-2010 4C 2.5L / | CF10548 <b>FRAM</b>      |
|   | CFI-8L8Z <b>INTERFIL</b> |
|   | 49466 <b>WIX</b>         |



| MAZDA   | JACBP4K                  |
|---|--------------------------|
| APLICACIÓN  | EQUIVALENCIA             |
| 3 2004-2009 4C 2.0L / 3 2004-2009 4C 2.3L / 5 2006-2010 4C 2.3L / 5 2011-2015 4C 2.5L / | CF10218 <b>FRAM</b>      |
|   | CFI-BP4K <b>INTERFIL</b> |
|   | 24482 <b>WIX</b>         |

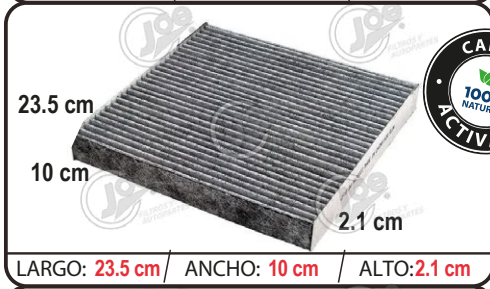

| MAZDA   | JACBP4KCA                |
|---|--------------------------|
| APLICACIÓN  | EQUIVALENCIA             |
| 3 2004-2009 4C 2.0L / 3 2004-2009 4C 2.3L / 5 2006-2010 4C 2.3L / 5 2011-2015 4C 2.5L / | CF10218 <b>FRAM</b>      |
|   | CFI-BP4K <b>INTERFIL</b> |
|   | 24482 <b>WIX</b>         |



| MAZDA                         | JACGJ6A                  |
|-------------------------------|--------------------------|
| APLICACIÓN                    | EQUIVALENCIA             |
| CX-7 2006-2012 4C2.3L TURBO / | CF11671 <b>FRAM</b>      |
|                               | CFI-GJ6A <b>INTERFIL</b> |
|                               | 24579 <b>WIX</b>         |

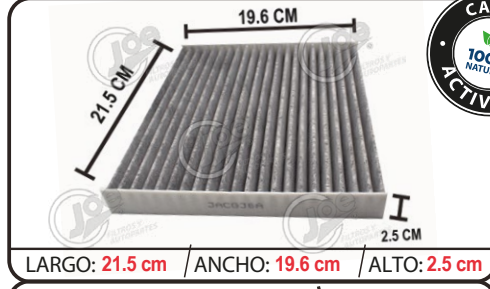

| MAZDA                         | JACGJ6ACA                |
|-------------------------------|--------------------------|
| APLICACIÓN                    | EQUIVALENCIA             |
| CX-7 2006-2012 4C2.3L TURBO / | CF11671 <b>FRAM</b>      |
|                               | CFI-GJ6A <b>INTERFIL</b> |
|                               | <b>WIX</b>               |



| MAZDA   | JACYL84                  |
|---|--------------------------|
| APLICACIÓN  | EQUIVALENCIA             |
| TRIBUTE 2001-2004 4C 2.0L / TRIBUTE 2005-2006 4C 2.3L / TRIBUTE 2001-2006 6C 3.0L / | CF10137 <b>FRAM</b>      |
|   | CFI-YL84 <b>INTERFIL</b> |
|   | 24816 <b>WIX</b>         |



|  |   |  |         |      |            |          |       |     |
|--|---|--|---------|------|------------|----------|-------|-----|
|  <p>27.3 cm<br/>16.9 cm<br/>3.0 cm</p> <p><b>CARBÓN ACTIVADO</b><br/>100% NATURAL</p> <p>LARGO: 27.3 cm / ANCHO: 16.9 cm / ALTO: 3.0 cm</p>                   | <p><b>MAZDA</b></p> <p>APLICACIÓN</p> <p>TRIBUTE 2001-2004 4C 2.0L / TRIBUTE 2005-2006 4C 2.3L / TRIBUTE 2001-2006 6C 3.0L /</p>  | <p><b>JACYL84CA</b></p> <p>EQUIVALENCIA</p> <table border="1"> <tr><td>CF10137</td><td>FRAM</td></tr> <tr><td>CFI-YL84CA</td><td>INTERFIL</td></tr> <tr><td>24816</td><td>WIX</td></tr> </table> | CF10137 | FRAM | CFI-YL84CA | INTERFIL | 24816 | WIX |
| CF10137  | FRAM  |  |         |      |            |          |       |     |
| CFI-YL84CA   | INTERFIL  |  |         |      |            |          |       |     |
| 24816  | WIX   |  |         |      |            |          |       |     |
|  <p>20.4 cm<br/>22.7 cm<br/>4 cm</p> <p><b>CARBÓN ACTIVADO</b><br/>100% NATURAL</p> <p>LARGO: 22.7 cm / ANCHO: 20.4 cm / ALTO: 4.0 cm</p>                     | <p><b>MERCEDES BENZ</b></p> <p>APLICACIÓN</p> <p>ML 320 1998-2003 6C 3.2L / ML 350 6C 3.5L / ML 350 2003-2005 6C 3.7L / ML 430 1998-2002 6C 4.3L /</p>  | <p><b>JAC1638CA</b></p> <p>EQUIVALENCIA</p> <table border="1"> <tr><td>CF8717A</td><td>FRAM</td></tr> <tr><td>CFI-1638CA</td><td>INTERFIL</td></tr> <tr><td>24867</td><td>WIX</td></tr> </table> | CF8717A | FRAM | CFI-1638CA | INTERFIL | 24867 | WIX |
| CF8717A  | FRAM  |  |         |      |            |          |       |     |
| CFI-1638CA   | INTERFIL  |  |         |      |            |          |       |     |
| 24867  | WIX   |  |         |      |            |          |       |     |
|  <p>25.5 cm<br/>35.5 cm<br/>3 cm</p> <p><b>CARBÓN ACTIVADO</b><br/>100% NATURAL</p> <p>LARGO: 35.5 cm / ANCHO: 25.5 cm / ALTO: 3 cm</p>                      | <p><b>MERCEDES BENZ</b></p> <p>APLICACIÓN</p> <p>A 160 2000-2004 4C 1.6L / A 190 2000 4C 1.9L /</p>   | <p><b>JAC1688CA</b></p> <p>EQUIVALENCIA</p> <table border="1"> <tr><td>N/D</td><td>FRAM</td></tr> <tr><td>CFI-1688CA</td><td>INTERFIL</td></tr> <tr><td>N/D</td><td>WIX</td></tr> </table>       | N/D     | FRAM | CFI-1688CA | INTERFIL | N/D   | WIX |
| N/D  | FRAM  |  |         |      |            |          |       |     |
| CFI-1688CA   | INTERFIL  |  |         |      |            |          |       |     |
| N/D  | WIX   |  |         |      |            |          |       |     |
|  <p>26.5 cm<br/>21.48 cm<br/>5.3 cm</p> <p><b>CARBÓN ACTIVADO</b><br/>100% NATURAL</p> <p>LARGO: 26.5 cm / ANCHO: 21.48 cm / ALTO: 5.3 cm</p>               | <p><b>MERCEDES BENZ</b></p> <p>APLICACIÓN</p> <p>C 200 KOMPRESSOR 2000 4C 1.8L / C 220 1994-1996 4C 2.2L / C 230 1997-2000 4C 2.3L / C 230 KOMPRESSOR 4C 1.8L / C 240 2001-2002 6C 2.6L / C 280 1994-2002 6C 2.8L / CLK 320 1998-2002 6C 3.2L / CABRIOLET 2002-2003 6C 3.2L / CLK 55 AMG 2001-2002 8C 5.5L / E 280 1996-2003 6C 2.8L / E 320 1999-2003 6C 3.2L / E 430 2000-2002 8C 4.2L / E 55 AMG 2001-2002 8C 5.5L / SLK 320 1998-2004 4C 2.3L / SLK 320 2001-2004 6C 3.2L /</p> | <p><b>JAC2028</b></p> <p>EQUIVALENCIA</p> <table border="1"> <tr><td>CF5842</td><td>FRAM</td></tr> <tr><td>CFI-2028</td><td>INTERFIL</td></tr> <tr><td>22767</td><td>WIX</td></tr> </table>      | CF5842  | FRAM | CFI-2028   | INTERFIL | 22767 | WIX |
| CF5842   | FRAM  |  |         |      |            |          |       |     |
| CFI-2028   | INTERFIL  |  |         |      |            |          |       |     |
| 22767  | WIX   |  |         |      |            |          |       |     |
|  <p>25.5 cm<br/>20.5 cm<br/>5.4 cm</p> <p><b>CARBÓN ACTIVADO</b><br/>100% NATURAL</p> <p>LARGO: 25.5 cm / ANCHO: 20.5 cm / ALTO: 5.4 cm</p>                 | <p><b>MERCEDES BENZ</b></p> <p>APLICACIÓN</p> <p>C 200 KOMPRESSOR 2000 4C 1.8L / C 220 1994-1996 4C 2.2L / C 230 1997-2000 4C 2.3L / C 230 KOMPRESSOR 4C 1.8L / C 240 2001-2002 6C 2.6L / C 280 1994-2002 6C 2.8L / CLK 320 1998-2002 6C 3.2L / CABRIOLET 2002-2003 6C 3.2L / CLK 55 AMG 2001-2002 8C 5.5L / E 280 1996-2003 6C 2.8L / E 320 1999-2003 6C 3.2L / E 430 2000-2002 8C 4.2L / E 55 AMG 2001-2002 8C 5.5L / SLK 320 1998-2004 4C 2.3L / SLK 320 2001-2004 6C 3.2L /</p> | <p><b>JAC2028CA</b></p> <p>EQUIVALENCIA</p> <table border="1"> <tr><td>CF5842</td><td>FRAM</td></tr> <tr><td>CFI-2028</td><td>INTERFIL</td></tr> <tr><td>22767</td><td>WIX</td></tr> </table>    | CF5842  | FRAM | CFI-2028   | INTERFIL | 22767 | WIX |
| CF5842   | FRAM  |  |         |      |            |          |       |     |
| CFI-2028   | INTERFIL  |  |         |      |            |          |       |     |
| 22767  | WIX   |  |         |      |            |          |       |     |
|  <p>18.8 cm<br/>33 cm<br/>27 cm<br/>19.3 cm<br/>2.6 cm</p> <p><b>CARBÓN ACTIVADO</b><br/>100% NATURAL</p> <p>LARGO: 33 cm / ANCHO: 27 cm / ALTO: 2.6 cm</p> | <p><b>MERCEDES BENZ</b></p> <p>APLICACIÓN</p> <p>C 200 KOMPRESSOR 2006-2007 4C 1.8L / C 280 2006-2007 6C 2.5L / MERCEDEZ BENZ C 280 2006-2007 6C 3.0L / C 300 KOMPRESSOR 2006-2007 4C 1.8L /</p>  | <p><b>JAC2038CA</b></p> <p>EQUIVALENCIA</p> <table border="1"> <tr><td>CF9905</td><td>FRAM</td></tr> <tr><td>CFI-2038</td><td>INTERFIL</td></tr> <tr><td>24118</td><td>WIX</td></tr> </table>    | CF9905  | FRAM | CFI-2038   | INTERFIL | 24118 | WIX |
| CF9905   | FRAM  |  |         |      |            |          |       |     |
| CFI-2038   | INTERFIL  |  |         |      |            |          |       |     |
| 24118  | WIX   |  |         |      |            |          |       |     |

|   |  |   |         |             |              |                 |         |            |
|---|--|---|---------|-------------|--------------|-----------------|---------|------------|
|  <p>25.9 cm<br/>27 cm<br/>8.4 cm</p> <p><b>CARBÓN ACTIVADO</b><br/>100% NATURAL</p> <p>LARGO: 27.0 cm / ANCHO: 25.9 cm / ALTO: 8.4 cm</p>     | <p><b>MERCEDES BENZ</b></p> <p><b>APLICACIÓN</b></p> <p>C 250 2012-2015 4C 1.8L TURBO / C 250 2010-2012 6C 2.5L / C 300 2008-2010 6C 2.5L / C 300 2008-2015 6C 3.5L / CLS 400 2015 6C 3.0L TURBO / CLS 550 2012-2015 8C 4.6L / CLS 63 2012-2015 8C 5.5L TURBO / CLS 63 2011 8C 6.3L / E 350 2010 6C 3.5L /</p> | <p><b>JAC2128CA</b></p> <p><b>EQUIVALENCIA</b></p> <table border="1"> <tr><td>N/D</td><td><b>FRAM</b></td></tr> <tr><td>CFI-2128CA</td><td><b>INTERFIL</b></td></tr> <tr><td>49357</td><td><b>WIX</b></td></tr> </table>        | N/D     | <b>FRAM</b> | CFI-2128CA   | <b>INTERFIL</b> | 49357   | <b>WIX</b> |
| N/D   | <b>FRAM</b>  |   |         |             |              |                 |         |            |
| CFI-2128CA  | <b>INTERFIL</b>  |   |         |             |              |                 |         |            |
| 49357   | <b>WIX</b>   |   |         |             |              |                 |         |            |
|  <p>35.4 cm<br/>23.0 cm<br/>3.6 cm</p> <p>LARGO: 35.4 cm / ANCHO: 23.0 cm / ALTO: 3.6 cm</p>  | <p><b>MERCEDES BENZ</b></p> <p><b>APLICACIÓN</b></p> <p>SPRINTER 2010-2014 6C 3.0L TURBO DIESEL / SPRINTER 315 CDI 2008-2009 5C 2.7L / SPRINTER 415 CDI 2008-2009 5C 2.7L / TURBO DIESEL / SPRINTER 515 CDI 2008-2009 5C 2.7L TURBO DIESEL / SPRINTER OM 647 2006-2007 5C 2.7L TURBO DIESEL /</p>              | <p><b>JAC9068</b></p> <p><b>EQUIVALENCIA</b></p> <table border="1"> <tr><td>PA10436</td><td><b>FRAM</b></td></tr> <tr><td>CFI-9068</td><td><b>INTERFIL</b></td></tr> <tr><td>49366</td><td><b>WIX</b></td></tr> </table>        | PA10436 | <b>FRAM</b> | CFI-9068     | <b>INTERFIL</b> | 49366   | <b>WIX</b> |
| PA10436   | <b>FRAM</b>  |   |         |             |              |                 |         |            |
| CFI-9068  | <b>INTERFIL</b>  |   |         |             |              |                 |         |            |
| 49366   | <b>WIX</b>   |   |         |             |              |                 |         |            |
|  <p>35.4 cm<br/>3.6 cm<br/>23 cm</p> <p><b>CARBÓN ACTIVADO</b><br/>100% NATURAL</p> <p>LARGO: 35.4 cm / ANCHO: 23.0 cm / ALTO: 3.6 cm</p>    | <p><b>MERCEDES BENZ</b></p> <p><b>APLICACIÓN</b></p> <p>SPRINTER 2010-2014 6C 3.0L TURBO DIESEL / SPRINTER 315 CDI 2008-2009 5C 2.7L / SPRINTER 415 CDI 2008-2009 5C 2.7L / TURBO DIESEL / SPRINTER 515 CDI 2008-2009 5C 2.7L TURBO DIESEL / SPRINTER OM 647 2006-2007 5C 2.7L TURBO DIESEL /</p>              | <p><b>JAC9068CA</b></p> <p><b>EQUIVALENCIA</b></p> <table border="1"> <tr><td>PA10436</td><td><b>FRAM</b></td></tr> <tr><td>CFI-9068CA</td><td><b>INTERFIL</b></td></tr> <tr><td>49366</td><td><b>WIX</b></td></tr> </table>    | PA10436 | <b>FRAM</b> | CFI-9068CA   | <b>INTERFIL</b> | 49366   | <b>WIX</b> |
| PA10436   | <b>FRAM</b>  |   |         |             |              |                 |         |            |
| CFI-9068CA  | <b>INTERFIL</b>  |   |         |             |              |                 |         |            |
| 49366   | <b>WIX</b>   |   |         |             |              |                 |         |            |
|  <p>24.6 cm<br/>18.8 cm<br/>3.2 cm</p> <p>LARGO: 24.6 cm / ANCHO: 18.8 cm / ALTO: 3.2 cm</p>  | <p><b>MERCEDES BENZ</b></p> <p><b>APLICACIÓN</b></p> <p>GL350 2014-2016 6C 3.0L / GL450 2015-2016 6C 3.0L / GL63 AMG 8C 5.5L / ML350 2014-2015 6C 3.5L /</p>   | <p><b>JAC10124</b></p> <p><b>EQUIVALENCIA</b></p> <table border="1"> <tr><td>N/D</td><td><b>FRAM</b></td></tr> <tr><td>CFI-10124</td><td><b>INTERFIL</b></td></tr> <tr><td>WP10124</td><td><b>WIX</b></td></tr> </table>        | N/D     | <b>FRAM</b> | CFI-10124    | <b>INTERFIL</b> | WP10124 | <b>WIX</b> |
| N/D   | <b>FRAM</b>  |   |         |             |              |                 |         |            |
| CFI-10124   | <b>INTERFIL</b>  |   |         |             |              |                 |         |            |
| WP10124   | <b>WIX</b>   |   |         |             |              |                 |         |            |
|  <p>20.6 cm<br/>28.3 cm<br/>3.5 cm</p> <p>LARGO: 28.3 cm / ANCHO: 20.6 cm / ALTO: 3.5 cm</p>  | <p><b>MERCEDES BENZ</b></p> <p><b>APLICACIÓN</b></p> <p>MERCEDES BENZ AM, GT, ML, GL, CLASE C, E, G, GLE, GLS, MOD, 2006-2022</p>  | <p><b>JAC11719</b></p> <p><b>EQUIVALENCIA</b></p> <table border="1"> <tr><td>CF11719</td><td><b>FRAM</b></td></tr> <tr><td>MANN CU25002</td><td><b>INTERFIL</b></td></tr> <tr><td>10124</td><td><b>WIX</b></td></tr> </table>   | CF11719 | <b>FRAM</b> | MANN CU25002 | <b>INTERFIL</b> | 10124   | <b>WIX</b> |
| CF11719   | <b>FRAM</b>  |   |         |             |              |                 |         |            |
| MANN CU25002  | <b>INTERFIL</b>  |   |         |             |              |                 |         |            |
| 10124   | <b>WIX</b>   |   |         |             |              |                 |         |            |
|  <p>20.6 cm<br/>28.3 cm<br/>3.5 cm</p> <p><b>CARBÓN ACTIVADO</b><br/>100% NATURAL</p> <p>LARGO: 28.3 cm / ANCHO: 20.6 cm / ALTO: 3.5 cm</p> | <p><b>MERCEDES BENZ</b></p> <p><b>APLICACIÓN</b></p> <p>MERCEDES BENZ AM, GT, ML, GL, CLASE C, E, G, GLE, GLS, MOD, 2006-2022</p>  | <p><b>JAC11719CA</b></p> <p><b>EQUIVALENCIA</b></p> <table border="1"> <tr><td>CF11719</td><td><b>FRAM</b></td></tr> <tr><td>MANN CU25002</td><td><b>INTERFIL</b></td></tr> <tr><td>10124</td><td><b>WIX</b></td></tr> </table> | CF11719 | <b>FRAM</b> | MANN CU25002 | <b>INTERFIL</b> | 10124   | <b>WIX</b> |
| CF11719   | <b>FRAM</b>  |   |         |             |              |                 |         |            |
| MANN CU25002  | <b>INTERFIL</b>  |   |         |             |              |                 |         |            |
| 10124   | <b>WIX</b>   |   |         |             |              |                 |         |            |



|   |  |  |         |             |            |                 |       |            |
|---|--|--|---------|-------------|------------|-----------------|-------|------------|
|  <p>21.5 cm<br/>30 cm<br/>3.5 cm</p> <p><b>CARBÓN ACTIVADO</b><br/>100% NATURAL</p> <p>LARGO: 30 cm / ANCHO: 21.5 cm / ALTO: 3.5 cm</p>    | <p><b>MERCEDES BENZ</b></p> <p>APLICACIÓN</p> <p>SPRINTER 1500 2020 2.0L / SPRINTER 2500 2020 3.0L / SPRINTER 3500 2020 3.0L</p> | <p><b>JAC30012CA</b></p> <p>EQUIVALENCIA</p> <table border="1"> <tr><td>N/D</td><td><b>FRAM</b></td></tr> <tr><td>N/D</td><td><b>INTERFIL</b></td></tr> <tr><td>N/D</td><td><b>WIX</b></td></tr> </table>            | N/D     | <b>FRAM</b> | N/D        | <b>INTERFIL</b> | N/D   | <b>WIX</b> |
| N/D   | <b>FRAM</b>  |  |         |             |            |                 |       |            |
| N/D   | <b>INTERFIL</b>  |  |         |             |            |                 |       |            |
| N/D   | <b>WIX</b>   |  |         |             |            |                 |       |            |
|  <p>3.3 cm<br/>21.0 cm<br/>26.5 cm</p> <p>LARGO: 26.5 cm / ANCHO: 21 cm / ALTO: 3.3 cm</p>   | <p><b>MERCURY</b></p> <p>APLICACIÓN</p> <p>MILAN 2010-2011 4C 2.5L / MILAN 2010-2011 6C 3.0L /</p>                               | <p><b>JAC11174</b></p> <p>EQUIVALENCIA</p> <table border="1"> <tr><td>CF11174</td><td><b>FRAM</b></td></tr> <tr><td>N/D</td><td><b>INTERFIL</b></td></tr> <tr><td>24367</td><td><b>WIX</b></td></tr> </table>        | CF11174 | <b>FRAM</b> | N/D        | <b>INTERFIL</b> | 24367 | <b>WIX</b> |
| CF11174   | <b>FRAM</b>  |  |         |             |            |                 |       |            |
| N/D   | <b>INTERFIL</b>  |  |         |             |            |                 |       |            |
| 24367   | <b>WIX</b>   |  |         |             |            |                 |       |            |
|  <p>21.0 cm<br/>26.5 cm<br/>3.3 cm</p> <p><b>CARBÓN ACTIVADO</b><br/>100% NATURAL</p> <p>LARGO: 26.5 cm / ANCHO: 21 cm / ALTO: 3.3 cm</p> | <p><b>MERCURY</b></p> <p>APLICACIÓN</p> <p>MILAN 2010-2011 4C 2.5L / MILAN 2010-2011 6C 3.0L /</p>                               | <p><b>JAC11174CA</b></p> <p>EQUIVALENCIA</p> <table border="1"> <tr><td>CF11174</td><td><b>FRAM</b></td></tr> <tr><td>N/D</td><td><b>INTERFIL</b></td></tr> <tr><td>24367</td><td><b>WIX</b></td></tr> </table>      | CF11174 | <b>FRAM</b> | N/D        | <b>INTERFIL</b> | 24367 | <b>WIX</b> |
| CF11174   | <b>FRAM</b>  |  |         |             |            |                 |       |            |
| N/D   | <b>INTERFIL</b>  |  |         |             |            |                 |       |            |
| 24367   | <b>WIX</b>   |  |         |             |            |                 |       |            |
|  <p>18.6 cm<br/>31.7 cm</p> <p>LARGO: 31.7 cm / ANCHO: 18.6 cm / ALTO: 1.9 cm</p>  | <p><b>MERCURY</b></p> <p>APLICACIÓN</p> <p>MARINER 2007-2011 4C 2.3L / MARINER 2007-2011 6C 3.0L / MARINER HIBRIDO 4C 2.3L /</p> | <p><b>JAC8L8Z</b></p> <p>EQUIVALENCIA</p> <table border="1"> <tr><td>CF10548</td><td><b>FRAM</b></td></tr> <tr><td>CFI-8L8Z</td><td><b>INTERFIL</b></td></tr> <tr><td>49466</td><td><b>WIX</b></td></tr> </table>    | CF10548 | <b>FRAM</b> | CFI-8L8Z   | <b>INTERFIL</b> | 49466 | <b>WIX</b> |
| CF10548   | <b>FRAM</b>  |  |         |             |            |                 |       |            |
| CFI-8L8Z  | <b>INTERFIL</b>  |  |         |             |            |                 |       |            |
| 49466   | <b>WIX</b>   |  |         |             |            |                 |       |            |
|  <p>52.0 cm<br/>1.80 cm</p> <p><b>CARBÓN ACTIVADO</b><br/>100% NATURAL</p>  | <p><b>MERCURY</b></p> <p>APLICACIÓN</p> <p>MYSTIQUE 1995-2000 4C 2.0L / MYSTIQUE 1995-2000 6C 2.5L /</p>                         | <p><b>JAC93BWCA</b></p> <p>EQUIVALENCIA</p> <table border="1"> <tr><td>CF8046</td><td><b>FRAM</b></td></tr> <tr><td>CFI-93BWCA</td><td><b>INTERFIL</b></td></tr> <tr><td>24771</td><td><b>WIX</b></td></tr> </table> | CF8046  | <b>FRAM</b> | CFI-93BWCA | <b>INTERFIL</b> | 24771 | <b>WIX</b> |
| CF8046  | <b>FRAM</b>  |  |         |             |            |                 |       |            |
| CFI-93BWCA  | <b>INTERFIL</b>  |  |         |             |            |                 |       |            |
| 24771   | <b>WIX</b>   |  |         |             |            |                 |       |            |
|  <p>26.5 cm<br/>17.8 cm</p> <p>LARGO: 26.5 cm / ANCHO: 17.8 cm / ALTO: 2.4 cm</p>  | <p><b>MERCURY</b></p> <p>APLICACIÓN</p> <p>SABLE 1996-2005 6C 3.0L /</p>   | <p><b>JACF6DZ</b></p> <p>EQUIVALENCIA</p> <table border="1"> <tr><td>CF8109A</td><td><b>FRAM</b></td></tr> <tr><td>CF8109A</td><td><b>INTERFIL</b></td></tr> <tr><td>24773</td><td><b>WIX</b></td></tr> </table>     | CF8109A | <b>FRAM</b> | CF8109A    | <b>INTERFIL</b> | 24773 | <b>WIX</b> |
| CF8109A   | <b>FRAM</b>  |  |         |             |            |                 |       |            |
| CF8109A   | <b>INTERFIL</b>  |  |         |             |            |                 |       |            |
| 24773   | <b>WIX</b>   |  |         |             |            |                 |       |            |



LARGO: 26.5 cm / ANCHO: 16.1 cm / ALTO: 3.0 cm

| MERCURY   |  | JACYL84      |                 |
|---|--|--------------|-----------------|
| APLICACIÓN  |  | EQUIVALENCIA |                 |
| MARINER 2005-2011 4C 2.5L / MARINER 2005-2011 6C 3.0L / MARINER HIBRIDO 2005-2008 4C 2.3L / |  | CF10137      | <b>FRAM</b>     |
|   |  | CFI-YL84     | <b>INTERFIL</b> |
|   |  | 24816        | <b>WIX</b>      |

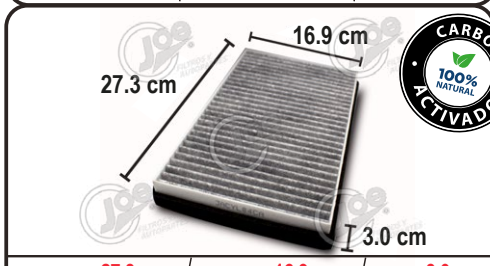

LARGO: 27.3 cm / ANCHO: 16.9 cm / ALTO: 3.0 cm

| MERCURY   |  | JACYL84CA    |                 |
|---|--|--------------|-----------------|
| APLICACIÓN  |  | EQUIVALENCIA |                 |
| MARINER 2005-2011 4C 2.5L / MARINER 2005-2011 6C 3.0L / MARINER HIBRIDO 2005-2008 4C 2.3L / |  | CF10137      | <b>FRAM</b>     |
|   |  | CFI-YL84CA   | <b>INTERFIL</b> |
|   |  | 24816        | <b>WIX</b>      |

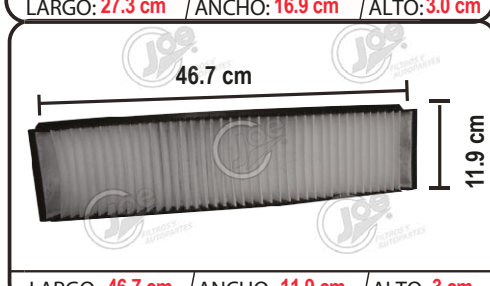

LARGO: 46.7 cm / ANCHO: 11.9 cm / ALTO: 3 cm

| MINI COOPER   |  | JAC6710      |                 |
|---|--|--------------|-----------------|
| APLICACIÓN  |  | EQUIVALENCIA |                 |
| MINI COOPER 2002-2006 4C 1.6L / MINI COOPER COUNTRYMAN 2007-2008 4C 1.6L / MINI COOPER COUNTRYMAN 2011-2016 4C 1.6L / MINI COOPER PACEMAN 2011-2016 4C 1.6L / MINI COOPER CLUBMAN 2008-2016 4C 1.6L / MINI COOPER S SUPERCHARGED 2005-2007 4C 1.6L / MINI COOPER SUPERCHARGED 2005-2008 4C 1.6L / |  | CF9594A      | <b>FRAM</b>     |
|   |  | CFI-6710     | <b>INTERFIL</b> |
|   |  | 24758        | <b>WIX</b>      |



LARGO: 46.7 cm / ANCHO: 11.9 cm / ALTO: 3 cm

| MINI COOPER   |  | JAC6710CA    |                 |
|---|--|--------------|-----------------|
| APLICACIÓN  |  | EQUIVALENCIA |                 |
| MINI COOPER 2002-2006 4C 1.6L / MINI COOPER COUNTRYMAN 2007-2008 4C 1.6L / MINI COOPER COUNTRYMAN 2011-2016 4C 1.6L / MINI COOPER CLUBMAN 2008-2016 4C 1.6L / MINI COOPER S SUPERCHARGED 2005-2007 4C 1.6L / MINI COOPER SUPERCHARGED 2005-2008 4C 1.6L / |  | CF9594A      | <b>FRAM</b>     |
|   |  | CFI-6710     | <b>INTERFIL</b> |
|   |  | 24758        | <b>WIX</b>      |

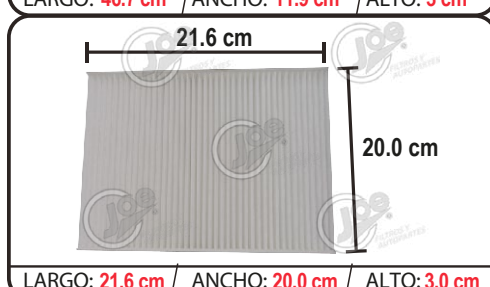

LARGO: 21.6 cm / ANCHO: 20.0 cm / ALTO: 3.0 cm

| MITSUBISHI  |  | JAC999M      |                 |
|---|--|--------------|-----------------|
| APLICACIÓN  |  | EQUIVALENCIA |                 |
| LANCER 2008-2015 4C 2.0L / LANCER 2009-2015 4C 2.4L / LANCER EVOLUTION 2008-2013 4C 2.0L / LANCER RALLIART 2009-2013 4C 2.0L TURBO / LANCER SPORTBACK 2010-2013 4C 2.0L TURBO / LANCER SPORTBACK 2010-2014 4C 2.4L / OUTLANDER 2007-2015 6C 3.0L / OUTLANDER SPORT 2011 4C 2.0L / OUTLANDER SPORT 2008-2019 4C 2.4L / |  | CF10140      | <b>FRAM</b>     |
|   |  | CFI-999M     | <b>INTERFIL</b> |
|   |  | 24857        | <b>WIX</b>      |

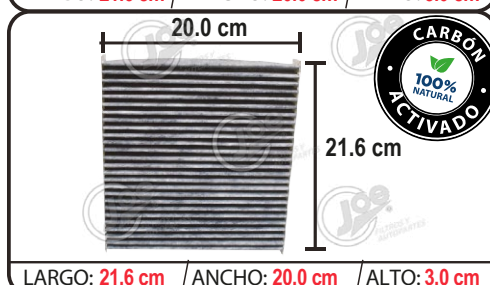

LARGO: 21.6 cm / ANCHO: 20.0 cm / ALTO: 3.0 cm

| MITSUBISHI  |  | JAC999MCA    |                 |
|---|--|--------------|-----------------|
| APLICACIÓN  |  | EQUIVALENCIA |                 |
| LANCER 2008-2015 4C 2.0L / LANCER 2009-2015 4C 2.4L / LANCER EVOLUTION 2008-2013 4C 2.0L / LANCER RALLIART 2009-2013 4C 2.0L TURBO / LANCER SPORTBACK 2010-2013 4C 2.0L TURBO / LANCER SPORTBACK 2010-2014 4C 2.4L / OUTLANDER 2007-2015 6C 3.0L / OUTLANDER SPORT 2011 4C 2.0L / OUTLANDER SPORT 2008-2019 4C 2.4L / |  | CF10140      | <b>FRAM</b>     |
|   |  | CFI-999M     | <b>INTERFIL</b> |
|   |  | 24857        | <b>WIX</b>      |

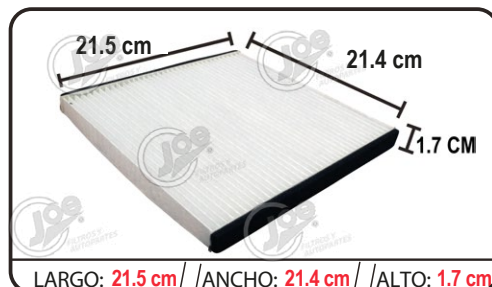

LARGO: 21.5 cm / ANCHO: 21.4 cm / ALTO: 1.7 cm

| MITSUBISHI   |  | JAC4701      |                 |
|--|--|--------------|-----------------|
| APLICACIÓN   |  | EQUIVALENCIA |                 |
| ENDEAVOR 2004-2011 6C 3.8L / GALANT 2004-2012 4C 2.4L / GALANT 2004-2009 6C 3.8L / |  | CF9846A      | <b>FRAM</b>     |
|  |  | CFI-4701     | <b>INTERFIL</b> |
|  |  |              | <b>WIX</b>      |



LARGO: 21.5 cm / ANCHO: 21.4 cm / ALTO: 1.7 cm

| MITSUBISHI   |  | JAC4701CA    |                 |
|--|--|--------------|-----------------|
| APLICACIÓN   |  | EQUIVALENCIA |                 |
| ENDEAVOR 2004-2011 6C 3.8L / GALANT 2004-2012 4C 2.4L / GALANT 2004-2009 6C 3.8L / |  | CF9846A      | <b>FRAM</b>     |
|  |  | CFI-4701     | <b>INTERFIL</b> |
|  |  | 24875        | <b>WIX</b>      |

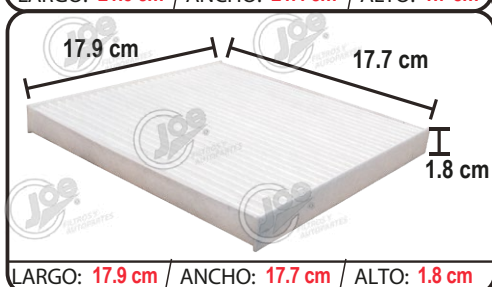

LARGO: 17.9 cm / ANCHO: 17.7 cm / ALTO: 1.8 cm

| MITSUBISHI                 |  | JAC7850      |                 |
|----------------------------|--|--------------|-----------------|
| APLICACIÓN                 |  | EQUIVALENCIA |                 |
| MIRAGE 2014-2019 4C 1.2L / |  | N/D          | <b>FRAM</b>     |
|                            |  | CFI-7850     | <b>INTERFIL</b> |
|                            |  | N/D          | <b>WIX</b>      |

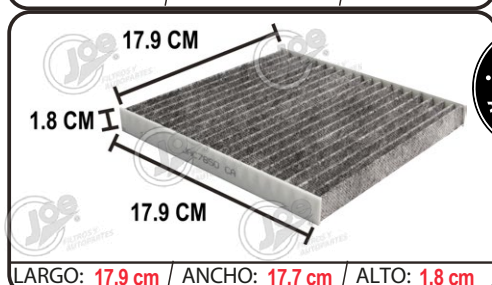

LARGO: 17.9 cm / ANCHO: 17.7 cm / ALTO: 1.8 cm

| MITSUBISHI                 |  | JAC7850CA    |                 |
|----------------------------|--|--------------|-----------------|
| APLICACIÓN                 |  | EQUIVALENCIA |                 |
| MIRAGE 2014-2019 4C 1.2L / |  | N/D          | <b>FRAM</b>     |
|                            |  | CFI-7850     | <b>INTERFIL</b> |
|                            |  | N/D          | <b>WIX</b>      |



LARGO: 22.2 cm / ANCHO: 21.3 cm / ALTO: 2 cm

| MITSUBISHI   |  | JAC8713      |                 |
|--|--|--------------|-----------------|
| APLICACIÓN   |  | EQUIVALENCIA |                 |
| ENDEAVOR 2004-2011 6C 3.8L / GALANT 2004-2012 4C 2.4L / GALANT 2004-2009 6C 3.8L / |  | CF10132      | <b>FRAM</b>     |
|  |  | CFI-8713     | <b>INTERFIL</b> |
|  |  | 24883        | <b>WIX</b>      |



LARGO: 22.2 cm / ANCHO: 21.3 cm / ALTO: 2 cm

| MITSUBISHI   |  | JAC8713CA    |                 |
|--|--|--------------|-----------------|
| APLICACIÓN   |  | EQUIVALENCIA |                 |
| ENDEAVOR 2004-2011 6C 3.8L / GALANT 2004-2012 4C 2.4L / GALANT 2004-2009 6C 3.8L / |  | CF10132      | <b>FRAM</b>     |
|  |  | CFI-8713     | <b>INTERFIL</b> |
|  |  | 24883        | <b>WIX</b>      |



| MITSUBISHI   |  | JACMR88CA    |                 |
|--|--|--------------|-----------------|
| APLICACIÓN   |  | EQUIVALENCIA |                 |
| L200 2009-2018 4C 2.4L / L200 2009-2018 4C 2.5L / LANCER 2002-2007 4C 2.0L / LANCER 4C 2.0L TURBO / LANCER 2004-2007 4C 2.4L / OUTLANDER 2003-2006 4C 2.4L / |  | CF10746      | <b>FRAM</b>     |
|  |  | CFI-MR88     | <b>INTERFIL</b> |
|  |  | 24756        | <b>WIX</b>      |

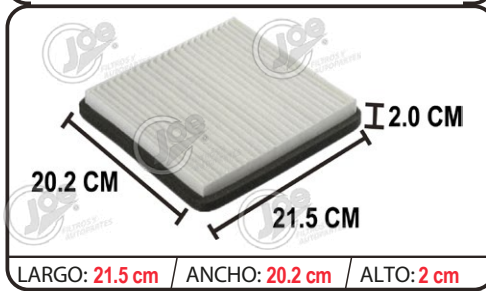

| MITSUBISHI                                    |  | JAC9538      |                 |
|---|--|--------------|-----------------|
| APLICACIÓN                                    |  | EQUIVALENCIA |                 |
| MONTERO 3.8 L 2015-2016 / PASAJEROS 2007-2104 |  | N/D          | <b>FRAM</b>     |
|   |  | N/D          | <b>INTERFIL</b> |
|   |  |              | <b>WIX</b>      |



| MITSUBISHI                                    |  | JAC9538CA    |                 |
|---|--|--------------|-----------------|
| APLICACIÓN                                    |  | EQUIVALENCIA |                 |
| MONTERO 3.8 L 2015-2016 / PASAJEROS 2007-2104 |  | N/D          | <b>FRAM</b>     |
|   |  | N/D          | <b>INTERFIL</b> |
|   |  | N/D          | <b>WIX</b>      |

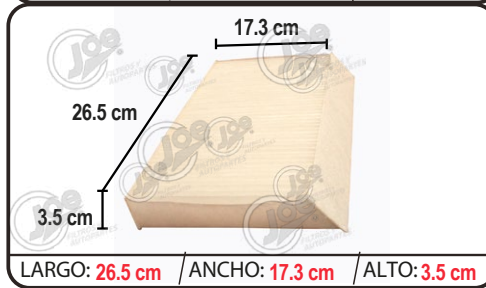

| NISSAN  |  | JAC2520      |                 |
|---|--|--------------|-----------------|
| APLICACIÓN  |  | EQUIVALENCIA |                 |
| SENTRA 2008-2012, TILDA 2008-2012, JUKE 2010-2014 |  | N/D          | <b>FRAM</b>     |
|   |  | N/D          | <b>INTERFIL</b> |
|   |  | WP2010       | <b>WIX</b>      |

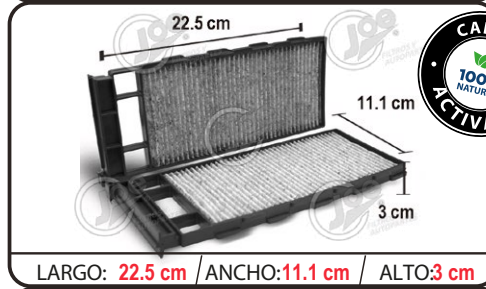

| NISSAN  |  | JAC2725CA    |                 |
|---|--|--------------|-----------------|
| APLICACIÓN  |  | EQUIVALENCIA |                 |
| ALTIMA 1998-2001 4C 2.4L / FRONTIER 2018-2019 4C 2.5L / FRONTIER 2018-2019 6C 4.0L / PATHFINDER 2000-2004 6C 2.5L / PATHFINDER 2004 8C 5.6L / |  | CF-10555     | <b>FRAM</b>     |
|   |  | CFI-2725     | <b>INTERFIL</b> |
|   |  | 24863        | <b>WIX</b>      |



| NISSAN  |  | JAC2727      |                 |
|---|--|--------------|-----------------|
| APLICACIÓN  |  | EQUIVALENCIA |                 |
| ALTIMA HIBRIDO 2007-2008 4C 2.5L / MAXIMA 2007-2010 6C 3.5L / ROGUE 2008-2014 4C 2.5L / SENTRA 2007-2012 4C 2.0L / SENTRA 2007-2012 4C 2.5L / X-TRAIL 2007-2010 4C 2.5L / |  | CF10555      | <b>FRAM</b>     |
|   |  | CFI-2727     | <b>INTERFIL</b> |
|   |  | 49352        | <b>WIX</b>      |



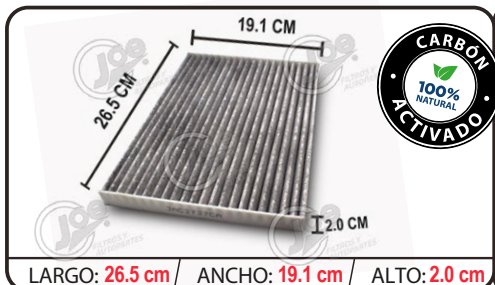

**NISSAN**

**JAC2727CA**

APLICACIÓN

EQUIVALENCIA

ALTIMA HIBRIDO 2007-2008 4C 2.5L / MAXIMA 2007-2010 6C 3.5L / ROGUE 2008-2014 4C 2.5L / SENTRA 2007-2012 4C 2.0L / SENTRA 2007-2012 4C 2.5L / X-TRAIL 2007-2010 4C 2.5L /

CF10555

**FRAM**

CFI-2727CA

**INTERFIL**

49352

**WIX**

LARGO: 26.5 cm / ANCHO: 19.1 cm / ALTO: 2.0 cm



**NISSAN**

**JAC2789**

APLICACIÓN

EQUIVALENCIA

TIIDA 2008-2018 4C 1.6L / TIIDA 2007-2018 4C 1.8L /

CF10545

**FRAM**

CFI-2789

**INTERFIL**

24829

**WIX**

LARGO: 21.5 cm / ANCHO: 17.4 cm / ALTO: 3.6 cm



**NISSAN**

**JAC7277**

APLICACIÓN

EQUIVALENCIA

NOTE 2013-2019 4C 1.6L / VERSA 2009-2019 4C 1.6 / VERSA 2007-2016 4C 1.8L / VERSA 2008-2009 4C 2.5L /

N/D

**FRAM**

CFI-7277

**INTERFIL**

WP2026

**WIX**

LARGO: 22.5 cm / ANCHO: 21 cm / ALTO: 2 cm

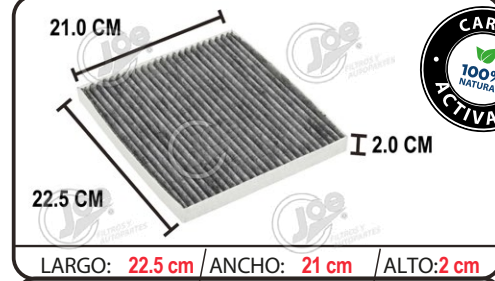

**NISSAN**

**JAC7277CA**

APLICACIÓN

EQUIVALENCIA

NOTE 2013-2019 4C 1.6L / VERSA 2009-2019 4C 1.6 / VERSA 2007-2016 4C 1.8L / VERSA 2008-2009 4C 2.5L /

N/D

**FRAM**

CFI-7277

**INTERFIL**

WP2026

**WIX**

LARGO: 22.5 cm / ANCHO: 21 cm / ALTO: 2 cm

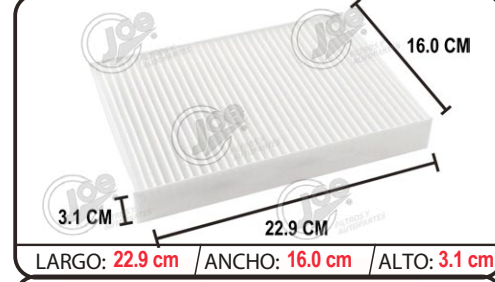

**NISSAN**

**JAC7700**

APLICACIÓN

EQUIVALENCIA

PLATINA 2002-2009 4C 1.6L / PLATINA 2002-2006 4C 2.0L /

CF8838

**FRAM**

CFI-7700

**INTERFIL**

N/D

**WIX**

LARGO: 22.9 cm / ANCHO: 16.0 cm / ALTO: 3.1 cm

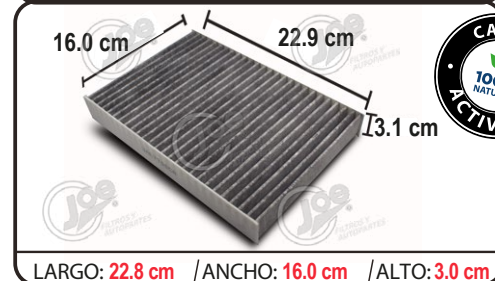

**NISSAN**

**JAC7700CA**

APLICACIÓN

EQUIVALENCIA

PLATINA 2002-2009 4C 1.6L / PLATINA 2002-2006 4C 2.0L /

CF8838

**FRAM**

CFI-7700CA

**INTERFIL**



N/D

**WIX**

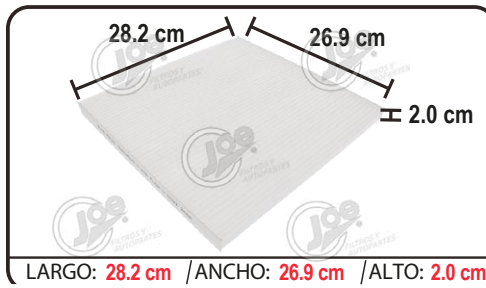
LARGO: 22.8 cm / ANCHO: 16.0 cm / ALTO: 3.0 cm



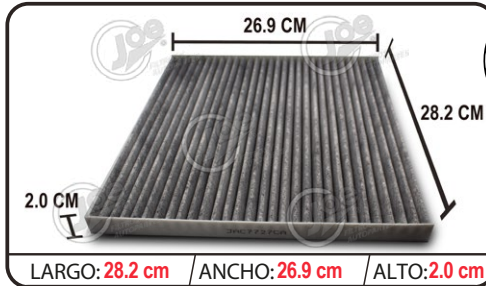

| NISSAN   |  | JAC7727      |                 |
|--|--|--------------|-----------------|
| APLICACIÓN   |  | EQUIVALENCIA |                 |
| ALTIMA 2007-2018 4C 2.5L / ALTIMA 2007-2018 4C 3.5L /<br>ALTIMA HIBRIDO 2007-2011 4C 2.5L / MAXIMA 2009-2019<br>6C 3.5L / MURANO CROSS CABRIOLET 2014 6C 3.5L /<br>PATHFINDER 2013-2019 6C 3.5L / QUEST 2011-2015 6C<br>3.5L / |  | CF11173      | <b>FRAM</b>     |
|  |  | CFI-7727     | <b>INTERFIL</b> |
|  |  |              | <b>WIX</b>      |

| NISSAN   |  | JAC7727CA    |                 |
|--|--|--------------|-----------------|
| APLICACIÓN   |  | EQUIVALENCIA |                 |
| ALTIMA 2007-2018 4C 2.5L / ALTIMA 2007-2018 4C 3.5L /<br>ALTIMA HIBRIDO 2007-2011 4C 2.5L / MAXIMA 2009-2019<br>6C 3.5L / MURANO CROSS CABRIOLET 2014 6C 3.5L /<br>PATHFINDER 2013-2019 6C 3.5L / QUEST 2011-2015 6C<br>3.5L / |  | CF11173      | <b>FRAM</b>     |
|  |  | CFI-7727     | <b>INTERFIL</b> |
|  |  | 24400        | <b>WIX</b>      |

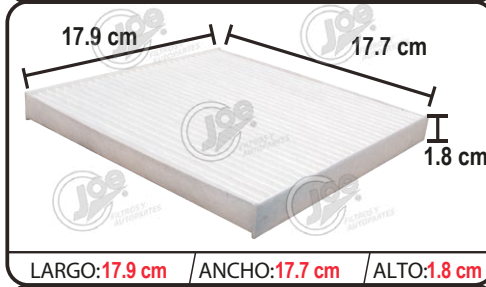

| NISSAN                    |  | JAC7850      |                 |
|---------------------------|--|--------------|-----------------|
| APLICACIÓN                |  | EQUIVALENCIA |                 |
| MARCH 2011-2019 4C 1.6L / |  | N/D          | <b>FRAM</b>     |
|                           |  | CFI-7850     | <b>INTERFIL</b> |
|                           |  | CFI-7850     | <b>WIX</b>      |

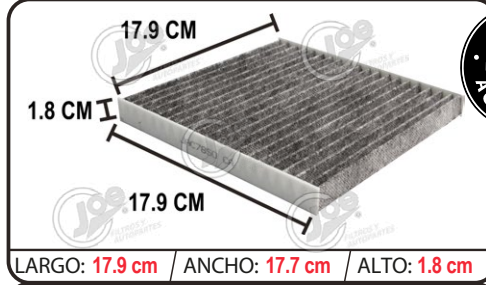
| NISSAN                    |  | JAC7850CA    |                 |
|---------------------------|--|--------------|-----------------|
| APLICACIÓN                |  | EQUIVALENCIA |                 |
| MARCH 2011-2019 4C 1.6L / |  | N/D          | <b>FRAM</b>     |
|                           |  | CFI-7850     | <b>INTERFIL</b> |
|                           |  | N/D          | <b>WIX</b>      |

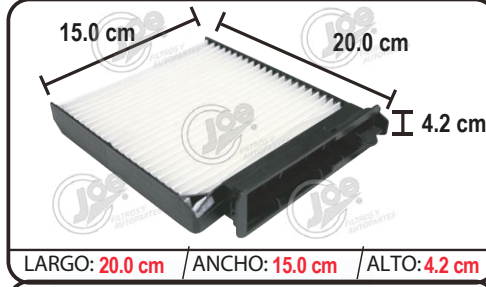

| NISSAN  |  | JAC8201      |                 |
|---|--|--------------|-----------------|
| APLICACIÓN  |  | EQUIVALENCIA |                 |
| NISSAN NOTE, MICRA MOD. 2005-2012 4 CIL. 1.4 LTS. |  | CFA9691      | <b>FRAM</b>     |
|   |  | CFI-8201     | <b>INTERFIL</b> |
|   |  | N/D          | <b>WIX</b>      |

| NISSAN  |  | JAC8201CA    |                 |
|---|--|--------------|-----------------|
| APLICACIÓN  |  | EQUIVALENCIA |                 |
| NISSAN NOTE, MICRA MOD. 2005-2012 4 CIL. 1.4 LTS. |  | CFA9691      | <b>FRAM</b>     |
|   |  | CFI-8201     | <b>INTERFIL</b> |
|   |  | N/D          | <b>WIX</b>      |

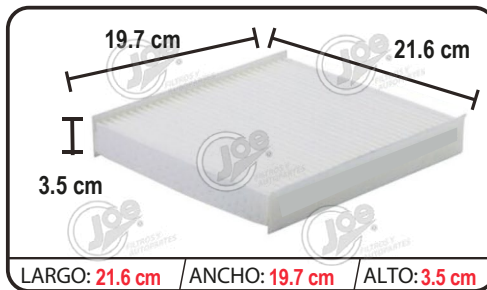

| NISSAN  |  | JAC8915      |          |
|---|--|--------------|----------|
| APLICACIÓN  |  | EQUIVALENCIA |          |
| KICS 1.6 L 4 CIL. 2017-2021 / VERSA 1.6 L. 4 CIL. 2018-2021, ALTIMA 2.5 L 3.5 L 2006-2012 / MAXIMA 3.5 L. 2008-2015 |  |              | FRAM     |
|   |  |              | INTERFIL |
|   |  | WP10425      | WIX      |

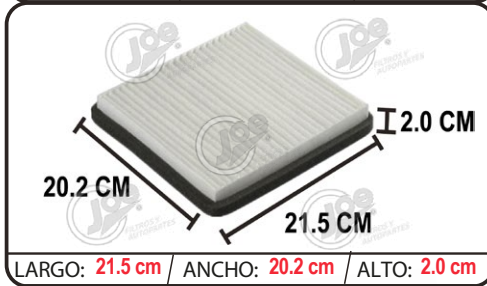

| NISSAN                   |  | JAC9538      |          |
|--------------------------|--|--------------|----------|
| APLICACIÓN               |  | EQUIVALENCIA |          |
| 370Z 2009-2019 6C 3.7L / |  | N/D          | FRAM     |
|                          |  | CFI-9538     | INTERFIL |
|                          |  |              | WIX      |



| NISSAN                   |  | JAC9538CA    |          |
|--------------------------|--|--------------|----------|
| APLICACIÓN               |  | EQUIVALENCIA |          |
| 370Z 2009-2019 6C 3.7L / |  | N/D          | FRAM     |
|                          |  | CFI-9538CA   | INTERFIL |
|                          |  | WP2020       | WIX      |

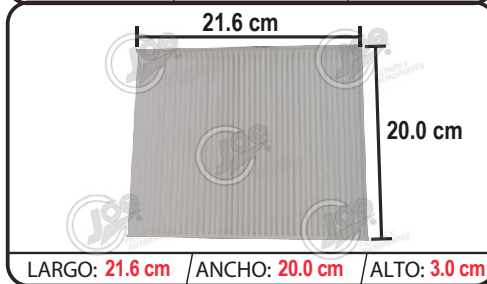

| NISSAN  |  | JAC999M      |          |
|---|--|--------------|----------|
| APLICACIÓN  |  | EQUIVALENCIA |          |
| ALTIMA 2002-2006 4C 2.5L / ALTIMA 2002-2006 4C 3.5L / MAXIMA 2004-2008 6C 3.5L / MURANO 2003-2007 6C 3.5L / SENTRA 2000-2006 4C 1.8L / SENTRA 2000-2001 2.0L / SENTRA 2002-2006 4C 2.5L / SENTRA SE-R 2003-2006 4C 2.5L / X-TRAIL 2005-2006 4C 2.5L / |  | CF10140      | FRAM     |
|   |  | CFI-999MCA   | INTERFIL |
|   |  | 24857        | WIX      |

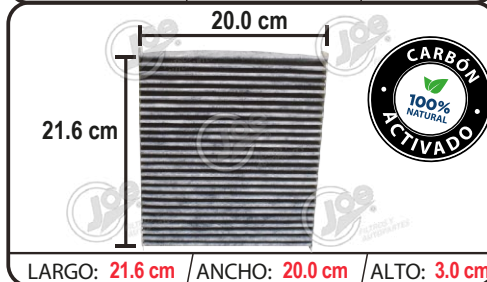

| NISSAN  |  | JAC999MCA    |          |
|---|--|--------------|----------|
| APLICACIÓN  |  | EQUIVALENCIA |          |
| ALTIMA 2002-2006 4C 2.5L / ALTIMA 2002-2006 4C 3.5L / MAXIMA 2004-2008 6C 3.5L / MURANO 2003-2007 6C 3.5L / SENTRA 2000-2006 4C 1.8L / SENTRA 2000-2001 2.0L / SENTRA 2002-2006 4C 2.5L / SENTRA SE-R 2003-2006 4C 2.5L / X-TRAIL 2005-2006 4C 2.5L / |  | CF10140      | FRAM     |
|   |  | CFI-999MCA   | INTERFIL |
|   |  | 24857        | WIX      |

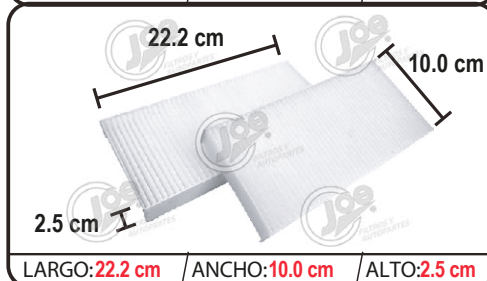

| NISSAN  |  | JAC10388     |          |
|---|--|--------------|----------|
| APLICACIÓN  |  | EQUIVALENCIA |          |
| NISSAN ARMADA MOD. 2010-2019 8 CIL. 5.6 LTS / NISSAN NV2500 MOD. 2012 8 CIL. 5.6 LTS / NISSAN NV3500 MOD. 2012 8 CIL. 5.6 LTS. / NISSAN TITAN MOD. 2004-2014 8 CIL. 5.6 LTS |  | CF10388      | FRAM     |
|   |  | CFI-10388    | INTERFIL |
|   |  | 24854        | WIX      |

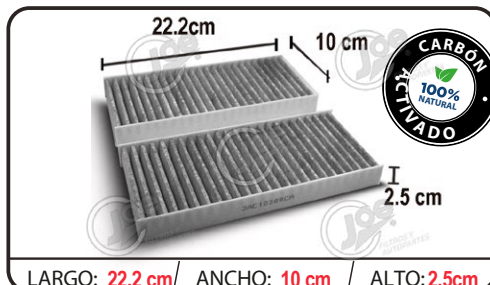

LARGO: 22.2 cm / ANCHO: 10 cm / ALTO: 2.5 cm

| NISSAN   |  | JAC10388CA   |                 |
|--|--|--------------|-----------------|
| APLICACIÓN   |  | EQUIVALENCIA |                 |
| NISSAN ARMADA MOD. 2010-2019 8 CIL. 5.6 LTS /<br>NISSAN NV2500 MOD. 2012 8 CIL. 5.6 LTS / NISSAN<br>NV3500 MOD. 2012 8 CIL. 5.6 LTS. / NISSAN TITAN MOD.<br>2004-2014 8 CIL. 5.6 LTS |  | CF10388      | <b>FRAM</b>     |
|  |  | CFI-10388    | <b>INTERFIL</b> |
|  |  |              | <b>WIX</b>      |



LARGO: 25.9 cm / ANCHO: 9.8 cm / ALTO: 2.4 cm

| NISSAN  |  | JAC10553     |                 |
|---|--|--------------|-----------------|
| APLICACIÓN  |  | EQUIVALENCIA |                 |
| FRONTIER 2005-2017 4C 2.5L / FRONTIER 2005-2017 6C 4.0L /<br>NAVARA 2011 4C 3.0L / NV1500 2012-2015 6C 4.0L / NV2500 6C<br>4.0L / NV2500 8C 5.6L / NV3500 2014-2015 6C 4.0L / 2014-2015<br>8C 5.6L / PATHFINDER 2005-2010 4C 2.5L / PATHFINDER<br>2005-2012 6C 4.0L / PATHFINDER 2008-2012 8C 5.6L / X-TERRA<br>2005-2015 6C 4.0L / |  | CF10553      | <b>FRAM</b>     |
|   |  | CFI-10553CA  | <b>INTERFIL</b> |
|   |  |              | <b>WIX</b>      |

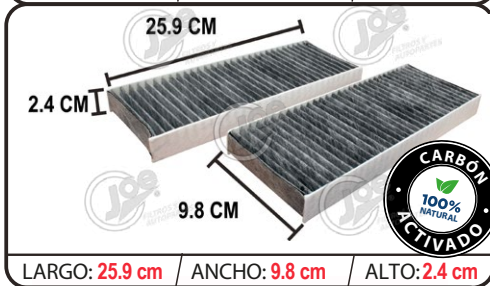

LARGO: 25.9 cm / ANCHO: 9.8 cm / ALTO: 2.4 cm

| NISSAN  |  | JAC10553CA   |                 |
|---|--|--------------|-----------------|
| APLICACIÓN  |  | EQUIVALENCIA |                 |
| FRONTIER 2005-2017 4C 2.5L / FRONTIER 2005-2017 6C 4.0L /<br>NAVARA 2011 4C 3.0L / NV1500 2012-2015 6C 4.0L / NV2500 6C<br>4.0L / NV2500 8C 5.6L / NV3500 2014-2015 6C 4.0L / 2014-2015<br>8C 5.6L / PATHFINDER 2005-2010 4C 2.5L / PATHFINDER<br>2005-2012 6C 4.0L / PATHFINDER 2008-2012 8C 5.6L / X-TERRA<br>2005-2015 6C 4.0L / |  | CF10553      | <b>FRAM</b>     |
|   |  | CFI-10553CA  | <b>INTERFIL</b> |
|   |  |              | <b>WIX</b>      |

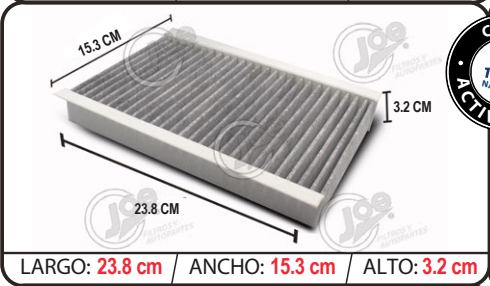

LARGO: 23.8 cm / ANCHO: 15.3 cm / ALTO: 3.2 cm

| NISSAN  |  | JAC1119CA    |                 |
|---|--|--------------|-----------------|
| APLICACIÓN  |  | EQUIVALENCIA |                 |
| JUKE, 1.2L 1.5L 1.6L 2010>2018, TIIDA 1.6L 2008>2012<br>ALMERA 1.6L 2001-2014<br>MANN CU1629 MAHLE LAK852 |  | CF11119      | <b>FRAM</b>     |
|   |  | N/D          | <b>INTERFIL</b> |
|   |  | WP2010       | <b>WIX</b>      |

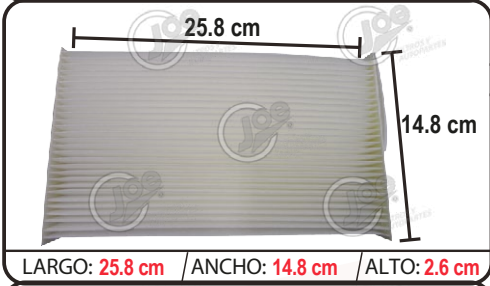

LARGO: 25.8 cm / ANCHO: 14.8 cm / ALTO: 2.6 cm

| NISSAN  |  | JAC11177     |                 |
|---|--|--------------|-----------------|
| APLICACIÓN  |  | EQUIVALENCIA |                 |
| CUBE 2009-2014 4C 1.8L / JUKE 2011-2018 4C 1.6L /<br>LEAFT 2011-2019 ELECTRICO / SENTRA 2017-2019 4C<br>1.6L / SENTRA 2013-2019 4C 1.8L / |  | CF11177      | <b>FRAM</b>     |
|   |  | CFI-11177    | <b>INTERFIL</b> |
|   |  | 24012        | <b>WIX</b>      |

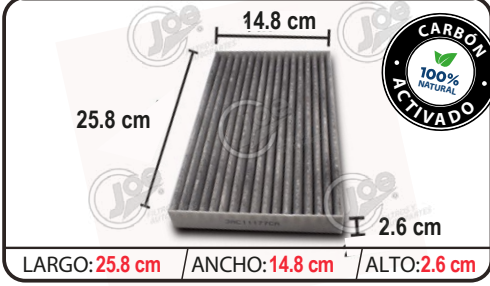

LARGO: 25.8 cm / ANCHO: 14.8 cm / ALTO: 2.6 cm

| NISSAN  |  | JAC11177CA   |                 |
|---|--|--------------|-----------------|
| APLICACIÓN  |  | EQUIVALENCIA |                 |
| CUBE 2009-2014 4C 1.8L / JUKE 2011-2018 4C 1.6L /<br>LEAFT 2011-2019 ELECTRICO / SENTRA 2017-2019 4C<br>1.6L / SENTRA 2013-2019 4C 1.8L / |  | CF11177      | <b>FRAM</b>     |
|   |  | CFI-11177    | <b>INTERFIL</b> |
|   |  | 24012        | <b>WIX</b>      |



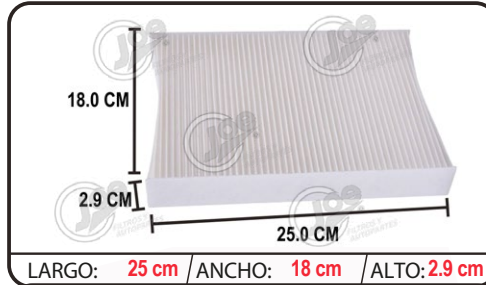

| NISSAN  |  | JAC11854     |          |
|---|--|--------------|----------|
| APLICACIÓN  |  | EQUIVALENCIA |          |
| QASHQAI 2017-2019 4C 2.0L / ROGUE 2017-2019 4C 2.0L / ROGUE 2015-2019 4C 2.5L / ROGUE 2017-2019 4C 2.0L / |  | CF11854      | FRAM     |
|   |  | N/D          | INTERFIL |
|   |  | WP10179      | WIX      |

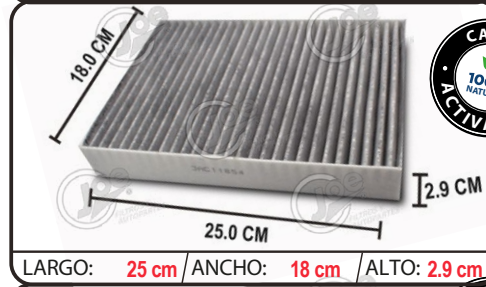

| NISSAN  |  | JAC11854CA   |          |
|---|--|--------------|----------|
| APLICACIÓN  |  | EQUIVALENCIA |          |
| QASHQAI 2017-2019 4C 2.0L / ROGUE 2017-2019 4C 2.0L / ROGUE 2015-2019 4C 2.5L / ROGUE 2017-2019 4C 2.0L / |  | CF11854      | FRAM     |
|   |  | N/D          | INTERFIL |
|   |  | WP10179      | WIX      |

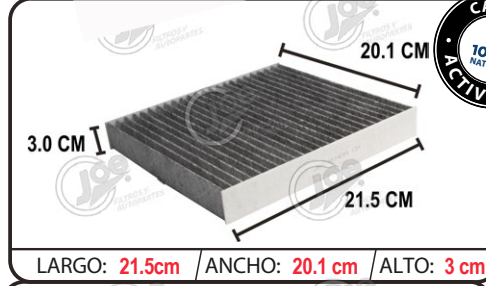

| NISSAN   |  | JAC4KH0ACA   |          |
|--|--|--------------|----------|
| APLICACIÓN   |  | EQUIVALENCIA |          |
| NP300 2015 -2011 4 C 2.5L / NP300 FRONTIER 2015 -2011 4 C 2.5L / |  | N/D          | FRAM     |
|  |  | N/D          | INTERFIL |
|  |  | N/D          | WIX      |

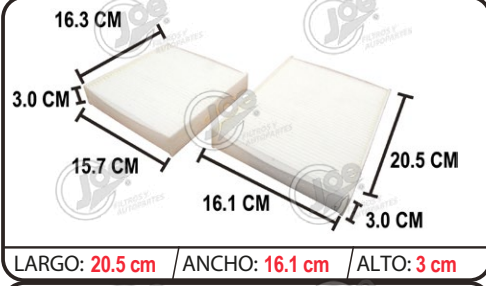

| PEUGEOT   |  | JAC1609                |          |
|---|--|------------------------|----------|
| APLICACIÓN  |  | EQUIVALENCIA           |          |
| 208 2012-2016 4C 1.2L / 301 2015-2018 4C 1.6L TURBO DIESEL / 208 GT 2015-2018 4C 1.6L TURBO / |  | N/D                    | FRAM     |
|   |  | CFI-1609<br>CFI-1609CA | INTERFIL |
|   |  | WP9256                 | WIX      |

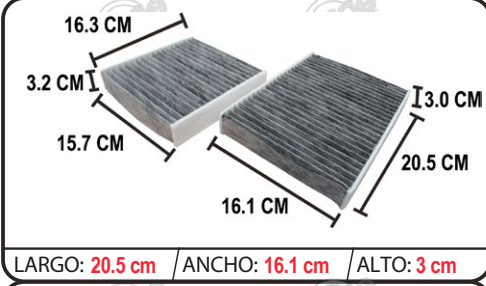

| PEUGEOT   |  | JAC1609CA              |          |
|---|--|------------------------|----------|
| APLICACIÓN  |  | EQUIVALENCIA           |          |
| 208 2012-2016 4C 1.2L / 301 2015-2018 4C 1.6L TURBO DIESEL / 208 GT 2015-2018 4C 1.6L TURBO / |  | N/D                    | FRAM     |
|   |  | CFI-1609<br>CFI-1609CA | INTERFIL |
|   |  | WP9256                 | WIX      |

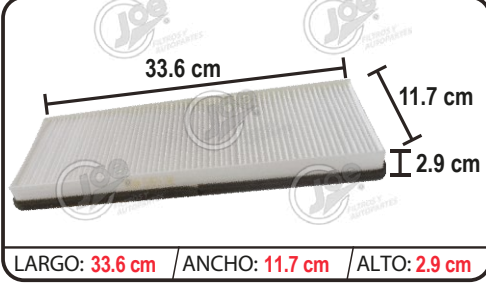

| PEUGEOT                 |  | JAC2484      |          |
|-------------------------|--|--------------|----------|
| APLICACIÓN              |  | EQUIVALENCIA |          |
| 306 1997-2002 4C 2.0L / |  | N/D          | FRAM     |
|                         |  | CFI-2484     | INTERFIL |
|                         |  | WP9256       | WIX      |

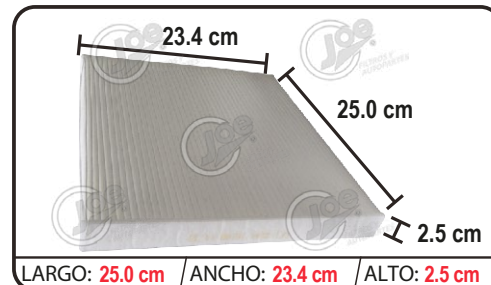

| PEUGEOT                                  | JAC2544                  |
|--|--------------------------|
| APLICACIÓN                               | EQUIVALENCIA             |
| MANAGER 2009-2015 4C 3.0L TURBO DIESEL / | N/D <b>FRAM</b>          |
|  | CFI-2544 <b>INTERFIL</b> |
|  | N/D <b>WIX</b>           |

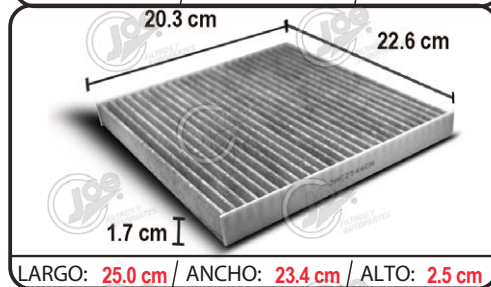

| PEUGEOT                                  | JAC2544CA                |
|--|--------------------------|
| APLICACIÓN                               | EQUIVALENCIA             |
| MANAGER 2009-2015 4C 3.0L TURBO DIESEL / | N/D <b>FRAM</b>          |
|  | CFI-2544 <b>INTERFIL</b> |
|  | <b>WIX</b>               |

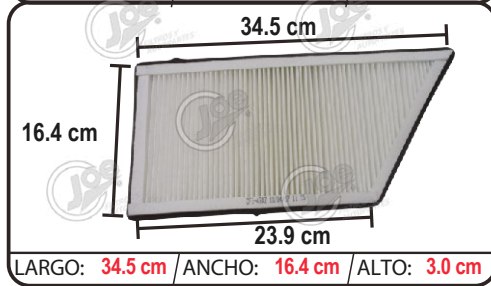

| PEUGEOT  | JAC47AZ                  |
|--|--------------------------|
| APLICACIÓN   | EQUIVALENCIA             |
| 206 XR 2000-2002 4C 1.4L / 206 XR 4C 1.6L / 206 XS 4C 1.4L / | CF9071 <b>FRAM</b>       |
|  | CFI-47AZ <b>INTERFIL</b> |
|  | WP6926 <b>WIX</b>        |



| PEUGEOT  | JAC47S5CA                  |
|--|----------------------------|
| APLICACIÓN   | EQUIVALENCIA               |
| 306 1999-2001 4C 1.4L / 306 1999-2003 4C 1.8L / 406 1999-2001 4C 1.6L / 406 1999-2000 4C 2.0L / 306 AMBIANCE COUPE 2000-2005 6C 3.0L / | N/D <b>FRAM</b>            |
|  | CFI-47S5CA <b>INTERFIL</b> |
|  | WP6841 <b>WIX</b>          |

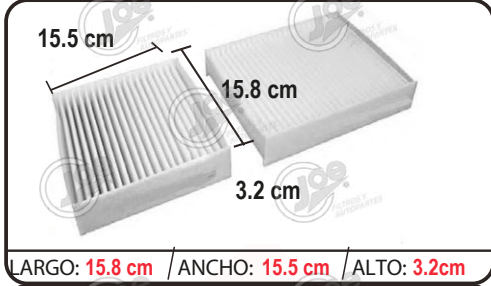

| PEUGEOT   | JAC47VY                  |
|---|--------------------------|
| APLICACIÓN  | EQUIVALENCIA             |
| 207 2006-2014 4C 1.4L / 207 2006-2014 4C 1.6L / 208 2012-2014 4C 1.4L / 208 2012-2014 4C 1.6L / 208 2013-2014 4C 1.2L / 208 2013-2014 4C 1.4L / 208 2013-2016 4C 1.6L / MANN CU21000, MAHLE LA191/S, SKY SKI1609, SKI47VY, CORTECO 80000667, CORTECO MP2642, NIKKO CFI1609CA, OEM 16094-28080, 6447VY, 6447VX, 644790 | CF10204-2 <b>FRAM</b>    |
|   | CFI-47VY <b>INTERFIL</b> |
|   | WP9256 <b>WIX</b>        |



| PEUGEOT   | JAC47VYCA                |
|---|--------------------------|
| APLICACIÓN  | EQUIVALENCIA             |
| 207 2006-2014 4C 1.4L / 207 2006-2014 4C 1.6L / 208 2012-2014 4C 1.4L / 208 2012-2014 4C 1.6L / 208 2013-2014 4C 1.2L / 208 2013-2014 4C 1.4L / 208 2013-2016 4C 1.6L / MANN CU21000, MAHLE LA191/S, SKY SKI1609, SKI47VY, CORTECO 80000667, CORTECO MP2642, NIKKO CFI1609CA, OEM 16094-28080, 6447VY, 6447VX, 644790 | CF10204-2 <b>FRAM</b>    |
|   | CFI-47VY <b>INTERFIL</b> |
|   | WP9256 <b>WIX</b>        |



| PEUGEOT   |  | JAC6479CA    |          |
|---|--|--------------|----------|
| APLICACIÓN  |  | EQUIVALENCIA |          |
| 307 2003-2006 4C 2.0L / 308 2010-2015 4C 1.6L TURBO / RCZ 2014-2017 4C 1.6L TURBO / |  | CF9398       | FRAM     |
|   |  | CFI-6479CA   | INTERFIL |
|   |  | WP9113       | WIX      |



| PEUGEOT  |  | JAC6493      |          |
|--|--|--------------|----------|
| APLICACIÓN   |  | EQUIVALENCIA |          |
| 3008 2009-2010 4C 2.0L / 5008 2009-2014 4C 1.6L / 3008 FELINE 2014-2017 4C 1.6L / 508 BERLINE 4C 1.6L / PARTNER 2009-2016 4C 1.6L TURBO DIESEL / |  | N/D          | FRAM     |
|  |  | CFI-6493CA   | INTERFIL |
|  |  | N/D          | WIX      |



| PEUGEOT  |  | JAC6493CA    |          |
|--|--|--------------|----------|
| APLICACIÓN   |  | EQUIVALENCIA |          |
| 3008 2009-2010 4C 2.0L / 5008 2009-2014 4C 1.6L / 3008 FELINE 2014-2017 4C 1.6L / 508 BERLINE 4C 1.6L / PARTNER 2009-2016 4C 1.6L TURBO DIESEL / |  | N/D          | FRAM     |
|  |  | CFI-6493CA   | INTERFIL |
|  |  | N/D          | WIX      |

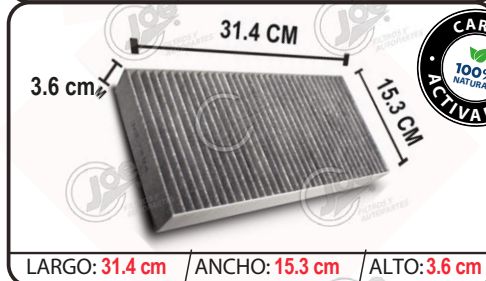

| PEUGEOT  |  | JAC7404CA    |          |
|--|--|--------------|----------|
| APLICACIÓN   |  | EQUIVALENCIA |          |
| 407 2005-2008 4C 1.6L / 407 2009-4C 1.6L / 407 2004-2005 4C 1.8L / 407 2005-2009 4C 2.0L / |  | N/D          | FRAM     |
|  |  | CFI-7404     | INTERFIL |
|  |  | N/D          | WIX      |

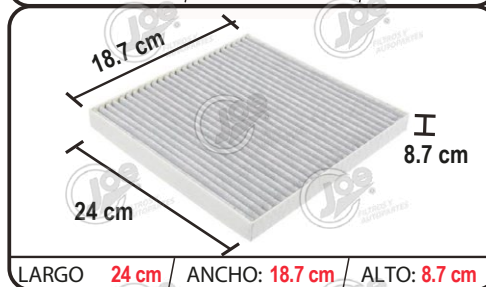

| PONTIAC                  |  | JAC0211       |          |
|--------------------------|--|---------------|----------|
| APLICACIÓN               |  | EQUIVALENCIA  |          |
| VIBE 2003-2008 4C 1.8L / |  | CF10374       | FRAM     |
|                          |  | CFI-0211      | INTERFIL |
|                          |  | 49358 / 24871 | WIX      |

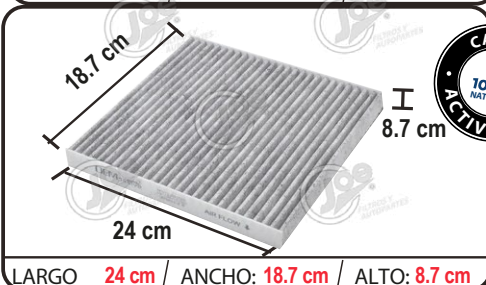

| PONTIAC                  |  | JAC0211CA     |          |
|--------------------------|--|---------------|----------|
| APLICACIÓN               |  | EQUIVALENCIA  |          |
| VIBE 2003-2008 4C 1.8L / |  | CF10374       | FRAM     |
|                          |  | CFI-0211      | INTERFIL |
|                          |  | 49358 / 24871 | WIX      |



LARGO: 29.0 cm / ANCHO: 19.0 cm / ALTO: 3.0 cm

| PONTIAC   |  | JAC1026      |          |
|---|--|--------------|----------|
| APLICACIÓN  |  | EQUIVALENCIA |          |
| GRAND PRIX 2004-2008 6C 3.8L / GRAND PRIX 2004-2008 8C 5.3L / |  | CF8392       | FRAM     |
|   |  | CFI-1026     | INTERFIL |
|   |  | 24780        | WIX      |



LARGO: 23.0 cm / ANCHO: 11.5 cm / ALTO: 3.9 cm

| PONTIAC   |  | JAC1030      |          |
|---|--|--------------|----------|
| APLICACIÓN  |  | EQUIVALENCIA |          |
| AZTEK 2001-2005 6C 3.4L / MONTANA 2005-2006 6C 3.5L / MONTANA 2006 6C 3.9L / SV-6 2007-2009 6C 3.5L / |  | CF10136      | FRAM     |
|   |  | CFI-1030     | INTERFIL |
|   |  | 24161        | WIX      |

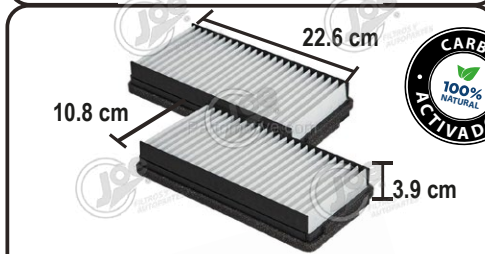

LARGO: 22.6 cm / ANCHO: 10.8 cm / ALTO: 3.9 cm

| PONTIAC   |  | JAC1030CA    |          |
|---|--|--------------|----------|
| APLICACIÓN  |  | EQUIVALENCIA |          |
| AZTEK 2001-2005 6C 3.4L / MONTANA 2005-2006 6C 3.5L / MONTANA 2006 6C 3.9L / SV-6 2007-2009 6C 3.5L / |  | CF10136      | FRAM     |
|   |  | CFI-1030     | INTERFIL |
|   |  | 24161        | WIX      |



LARGO: 42.3 cm / ANCHO: 11.0 cm / ALTO: 3.1 cm

| PONTIAC   |  | JAC2272CA    |          |
|---|--|--------------|----------|
| APLICACIÓN  |  | EQUIVALENCIA |          |
| TORRENT 2006-2009 6C 3.4L / TORRENT 2008-2009 / 6C 3.6L / |  | CF10141      | FRAM     |
|   |  | CFI-2272     | INTERFIL |
|   |  | 24872        | WIX      |



LARGO: 22.0 cm / ANCHO: 10.4 cm / ALTO: 6.0 cm

| PONTIAC   |  | JAC5248CA    |          |
|---|--|--------------|----------|
| APLICACIÓN  |  | EQUIVALENCIA |          |
| MONTANA 1999-2000 6C 3.4L / TRANS SPORT APV 1996-1999 6C 3.4L / |  | 8327         | FRAM     |
|   |  | CFI-5248CA   | INTERFIL |
|   |  | 24811        | WIX      |

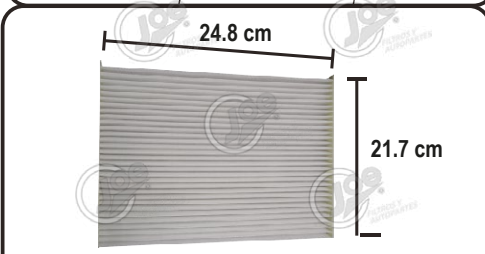

LARGO: 24.8 cm / ANCHO: 21.7 cm / ALTO: 2.3 cm

| PONTIAC  |  | JAC5249      |          |
|--|--|--------------|----------|
| APLICACIÓN   |  | EQUIVALENCIA |          |
| G5 2007-2011 4C 2.4L / G7 2009 4C 2.2L / G8 2010 4C 2.2L / G9 2007-2009 4C 2.4L / PURSIT CANADA 2005-2006 4C 2.0L / PURSIT CANADA 2005-2006 4C 2.2L / PURSIT CANADA 2006 4C 2.4L / |  | CF10361      | FRAM     |
|  |  | CFI-5249     | INTERFIL |
|  |  | 24811        | WIX      |

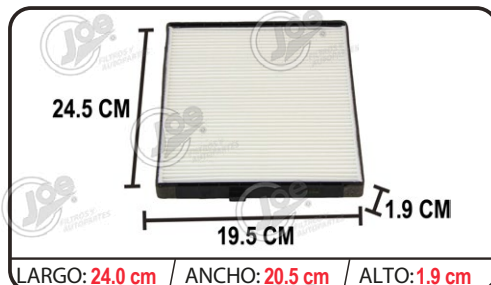

| PONTIAC                |  | JAC9696      |          |
|------------------------|--|--------------|----------|
| APLICACIÓN             |  | EQUIVALENCIA |          |
| G5 2009-2010 4C 1.6L / |  | CF10546      | FRAM     |
|                        |  | CFI-9696     | INTERFIL |
|                        |  | 24685        | WIX      |

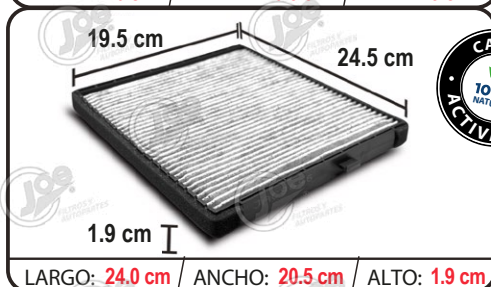

| PONTIAC                |  | JAC9696CA    |          |
|------------------------|--|--------------|----------|
| APLICACIÓN             |  | EQUIVALENCIA |          |
| G5 2009-2010 4C 1.6L / |  | CF10546      | FRAM     |
|                        |  | CFI-9696     | INTERFIL |
|                        |  | 24685        | WIX      |

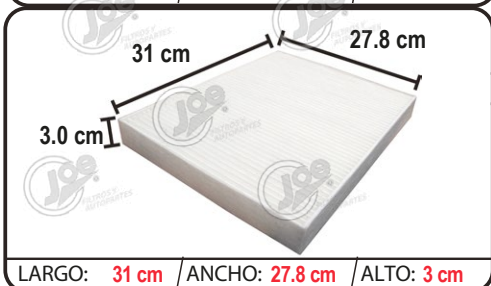

| PORSCHE   |  | JAC7H08      |          |
|---|--|--------------|----------|
| APLICACIÓN  |  | EQUIVALENCIA |          |
| CAYENNE 2013-2014 6C 3.0L TURBO DIESEL / PORSC HE CAYENNE 2004-2007 6C 3.2L / CAYENNE 2008-2015 6C 3.6L / CAYENNE 2003-2007 8C 4.5L / CAYENNE 2003-2007 8C 4.5L TURBO / CAYENNE 2008-2013 8C 4.8L / CAYENNE 2008-2015 8C 4.8L TURBO / CAYENNE HIBRIDO 2011-2015 6C 3.0L / |  | CF9881       | FRAM     |
|   |  | CFI-7H08     | INTERFIL |
|   |  | 24631        | WIX      |

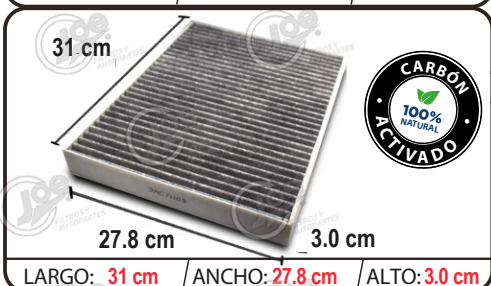

| PORSCHE   |  | JAC7H08CA    |          |
|---|--|--------------|----------|
| APLICACIÓN  |  | EQUIVALENCIA |          |
| CAYENNE 2013-2014 6C 3.0L TURBO DIESEL / PORSC HE CAYENNE 2004-2007 6C 3.2L / CAYENNE 2008-2015 6C 3.6L / CAYENNE 2003-2007 8C 4.5L / CAYENNE 2003-2007 8C 4.5L TURBO / CAYENNE 2008-2013 8C 4.8L / CAYENNE 2008-2015 8C 4.8L TURBO / CAYENNE HIBRIDO 2011-2015 6C 3.0L / |  | CF9881       | FRAM     |
|   |  | CFI-7H08     | INTERFIL |
|   |  | 24631        | WIX      |

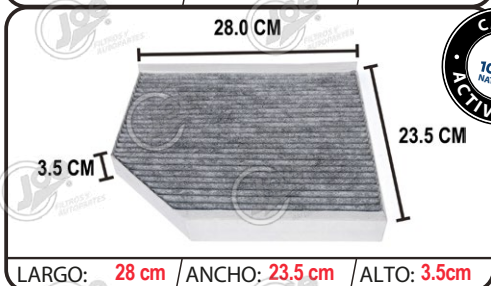

| PORSCHE                                   |  | JAC8K08CA    |          |
|---|--|--------------|----------|
| APLICACIÓN                                |  | EQUIVALENCIA |          |
| MACAN 2015 6C 3.0L / MACAN 2015 6C 3.6L / |  | CF11179      | FRAM     |
|   |  | CFI-8K08     | INTERFIL |
|   |  | 24227        | WIX      |

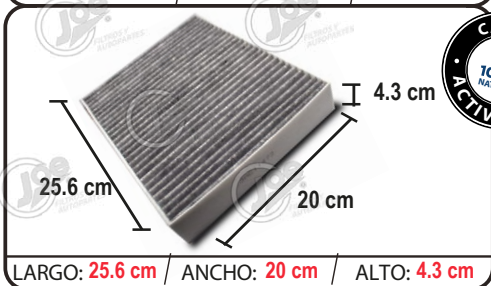

| PORSCHE  |  | JAC11472CA   |          |
|--|--|--------------|----------|
| APLICACIÓN   |  | EQUIVALENCIA |          |
| BOSTER, CAYENE, CAYMAN, 2.0L, 2.5L, 2.7L, 3.0L, 3.4, 3.8L Y 4.0L MOD 2016-2022 |  |              | FRAM     |
|  |  |              | INTERFIL |
|  |  |              | WIX      |

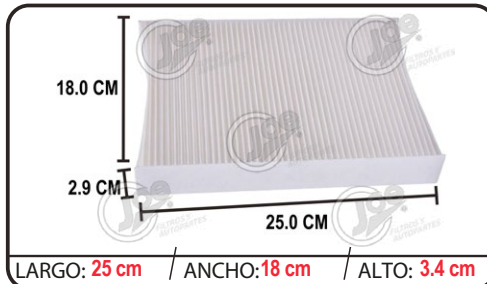

LARGO: 25 cm / ANCHO: 18 cm / ALTO: 3.4 cm

| RENAULT   |  | JAC11854     |                 |
|---|--|--------------|-----------------|
| APLICACIÓN  |  | EQUIVALENCIA |                 |
| QASHQAI 2017-2019 4C 2.0L / ROGUE 2017-2019 4C 2.0L / ROGUE 2015-2019 4C 2.5L / ROGUE 2017-2019 4C 2.0L / |  | CF11854      | <b>FRAM</b>     |
|   |  | N/D          | <b>INTERFIL</b> |
|   |  | WP10179      | <b>WIX</b>      |

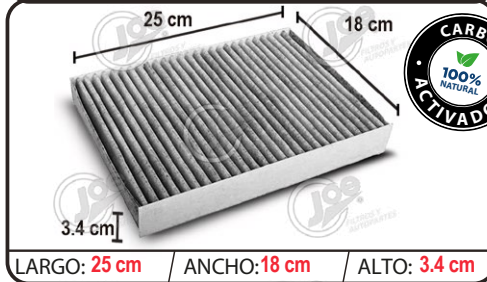

LARGO: 25 cm / ANCHO: 18 cm / ALTO: 3.4 cm

| RENAULT   |  | JAC11854CA   |                 |
|---|--|--------------|-----------------|
| APLICACIÓN  |  | EQUIVALENCIA |                 |
| QASHQAI 2017-2019 4C 2.0L / ROGUE 2017-2019 4C 2.0L / ROGUE 2015-2019 4C 2.5L / ROGUE 2017-2019 4C 2.0L / |  | CF11854      | <b>FRAM</b>     |
|   |  | N/D          | <b>INTERFIL</b> |
|   |  | WP10179      | <b>WIX</b>      |

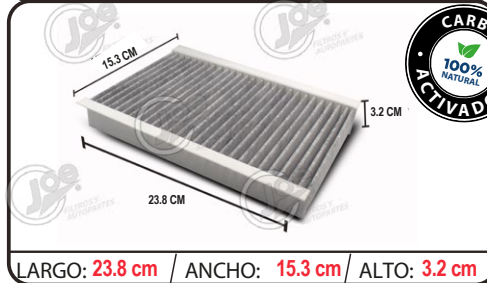

LARGO: 23.8 cm / ANCHO: 15.3 cm / ALTO: 3.2 cm

| RENAULT  |  | JAC1119CA    |                 |
|--|--|--------------|-----------------|
| APLICACIÓN   |  | EQUIVALENCIA |                 |
| FLUENCE 1.6 L, 2010>2011<br>MANN CU1629 MAHLE LAK852 |  | CF11119      | <b>FRAM</b>     |
|  |  | N/D          | <b>INTERFIL</b> |
|  |  | WP2010       | <b>WIX</b>      |

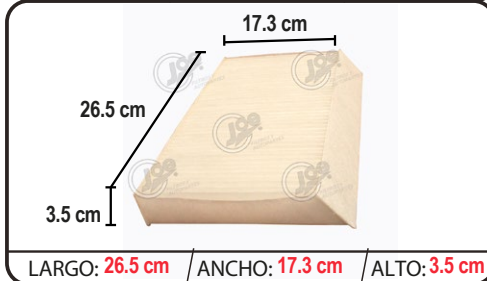

LARGO: 26.5 cm / ANCHO: 17.3 cm / ALTO: 3.5 cm

| RENAULT  |  | JAC2520      |                 |
|--|--|--------------|-----------------|
| APLICACIÓN   |  | EQUIVALENCIA |                 |
| FLUENCE 1.5 L. 2.0L. 2010-2011<br>MEGANE III 1.6 L. 2008-20016 |  | N/D          | <b>FRAM</b>     |
|  |  | N/D          | <b>INTERFIL</b> |
|  |  | WP2010       | <b>WIX</b>      |

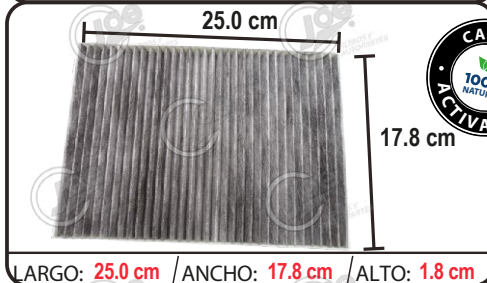

LARGO: 25.0 cm / ANCHO: 17.8 cm / ALTO: 1.8 cm

| RENAULT                    |  | JAC2620CA    |                 |
|----------------------------|--|--------------|-----------------|
| APLICACIÓN                 |  | EQUIVALENCIA |                 |
| KOLEOS 2008-2011 4C 2.0L / |  | N/D          | <b>FRAM</b>     |
|                            |  | CFI-2620CA   | <b>INTERFIL</b> |
|                            |  | N/D          | <b>WIX</b>      |



LARGO: 25.5 cm / ANCHO: 10.1 cm / ALTO: 2.5 cm

| RENAULT   |  | JAC2771      |                 |
|---|--|--------------|-----------------|
| APLICACIÓN  |  | EQUIVALENCIA |                 |
| SAFRANE 2011-2015 4C 1.5L / SAFRANE 2011-2015 4C 2.0L / |  | N/D          | <b>FRAM</b>     |
|   |  | CFI-2771     | <b>INTERFIL</b> |
|   |  | N/D          | <b>WIX</b>      |

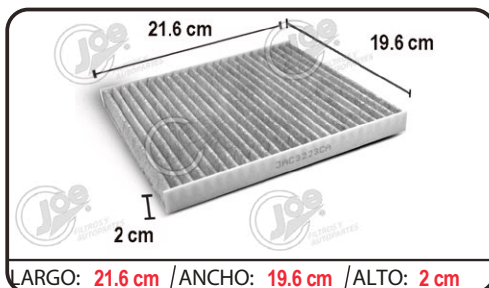

| RENAULT   |  | JAC3223      |                 |
|---|--|--------------|-----------------|
| APLICACIÓN  |  | EQUIVALENCIA |                 |
| DUSTER 2011-2015 4C 2.0L / KOLEOS 2008-2015 4C 2.5L / |  | N/D          | <b>FRAM</b>     |
|   |  | CFI-3223     | <b>INTERFIL</b> |
|   |  | N/D          | <b>WIX</b>      |

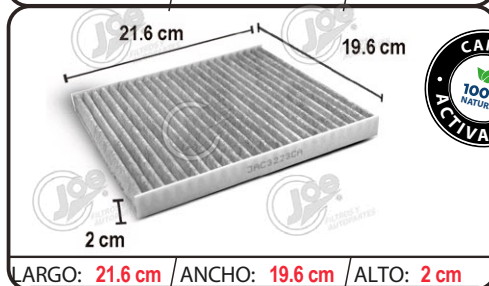

| RENAULT   |  | JAC3223CA    |                 |
|---|--|--------------|-----------------|
| APLICACIÓN  |  | EQUIVALENCIA |                 |
| DUSTER 2011-2015 4C 2.0L / KOLEOS 2008-2015 4C 2.5L / |  | N/D          | <b>FRAM</b>     |
|   |  | CFI-3223     | <b>INTERFIL</b> |
|   |  | N/D          | <b>WIX</b>      |

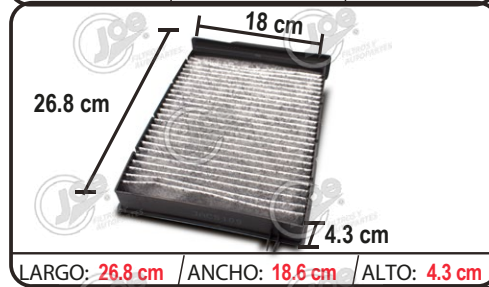

| RENAULT                                     |  | JAC5109      |                 |
|---|--|--------------|-----------------|
| APLICACIÓN                                  |  | EQUIVALENCIA |                 |
| MEGANE 4 CIL. 2.0 LTS. TURBO MOD. 2005-2006 |  | N/D          | <b>FRAM</b>     |
|   |  | CFI-5109     | <b>INTERFIL</b> |
|   |  | WP9174       | <b>WIX</b>      |

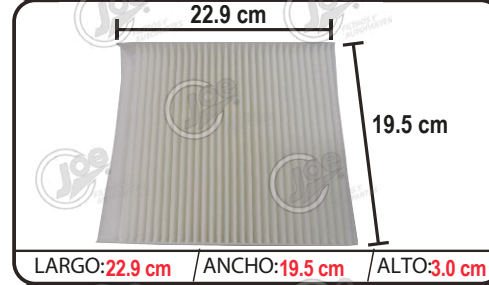

| RENAULT  |  | JAC7513      |                 |
|--|--|--------------|-----------------|
| APLICACIÓN   |  | EQUIVALENCIA |                 |
| SCENIC 1999-2003 4C 1.4L / SCENIC 1999-2003 4C 1.6L / SCENIC 1999-2003 4C 1.8L / |  | N/D          | <b>FRAM</b>     |
|  |  | CFI-7513     | <b>INTERFIL</b> |
|  |  | WP6938       | <b>WIX</b>      |

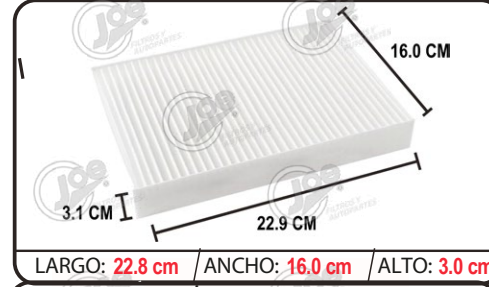

| RENAULT   |  | JAC7700      |                 |
|---|--|--------------|-----------------|
| APLICACIÓN  |  | EQUIVALENCIA |                 |
| CLIO 2001-2009 4C 1.6L / CLIO SPORT 2002-2006 4C 2.0L / KANGOO 2003-2018 4C 1.6L / MEGANE 2001-2002 4C 2.0L / |  | CF8838       | <b>FRAM</b>     |
|   |  | CFI-7700     | <b>INTERFIL</b> |
|   |  | N/D          | <b>WIX</b>      |

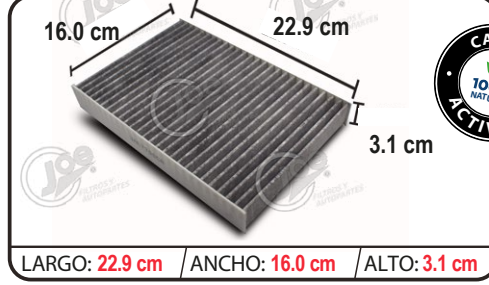

| RENAULT   |  | JAC7700CA    |                 |
|---|--|--------------|-----------------|
| APLICACIÓN  |  | EQUIVALENCIA |                 |
| CLIO 2001-2009 4C 1.6L / CLIO SPORT 2002-2006 4C 2.0L / KANGOO 2003-2018 4C 1.6L / MEGANE 2001-2002 4C 2.0L / |  | CF8838       | <b>FRAM</b>     |
|   |  | CFI-7700CA   | <b>INTERFIL</b> |
|   |  | N/D          | <b>WIX</b>      |

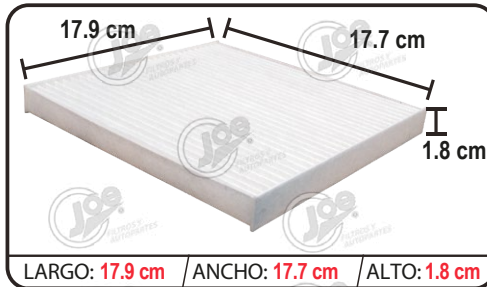

| RENAULT                   | JAC7850      |                 |
|---------------------------|--------------|-----------------|
| APLICACIÓN                | EQUIVALENCIA |                 |
| LOGAN 2015-2017 4C 1.6L / | N/D          | <b>FRAM</b>     |
|                           | CFI-7850     | <b>INTERFIL</b> |
|                           | N/D          | <b>WIX</b>      |

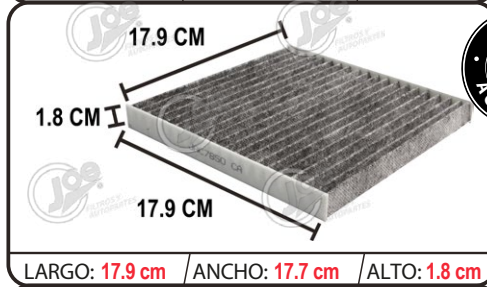

| RENAULT                   | JAC7850CA    |                 |
|---------------------------|--------------|-----------------|
| APLICACIÓN                | EQUIVALENCIA |                 |
| LOGAN 2015-2017 4C 1.6L / | N/D          | <b>FRAM</b>     |
|                           | CFI-7850     | <b>INTERFIL</b> |
|                           | N/D          | <b>WIX</b>      |

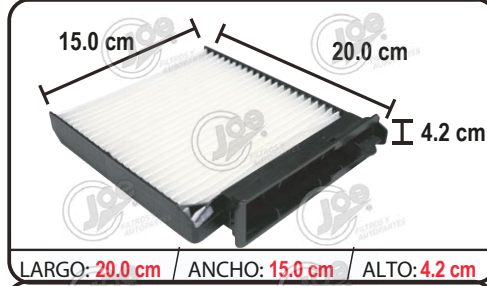

| RENAULT   | JAC8201      |                 |
|---|--------------|-----------------|
| APLICACIÓN  | EQUIVALENCIA |                 |
| DUSTER MOS. 2010-2018 4 CIL. 2.0 LTS. / KOLEOS MOD. 2016-2017 4 CIL. 2.5 LTS. | CFA9691      | <b>FRAM</b>     |
|   | CFI-8201     | <b>INTERFIL</b> |
|   | N/D          | <b>WIX</b>      |

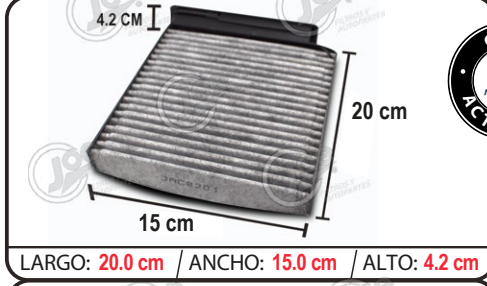

| RENAULT   | JAC8201CA    |                 |
|---|--------------|-----------------|
| APLICACIÓN  | EQUIVALENCIA |                 |
| DUSTER MOS. 2010-2018 4 CIL. 2.0 LTS. / KOLEOS MOD. 2016-2017 4 CIL. 2.5 LTS. | CFA9691      | <b>FRAM</b>     |
|   | CFI-8201     | <b>INTERFIL</b> |
|   | N/D          | <b>WIX</b>      |

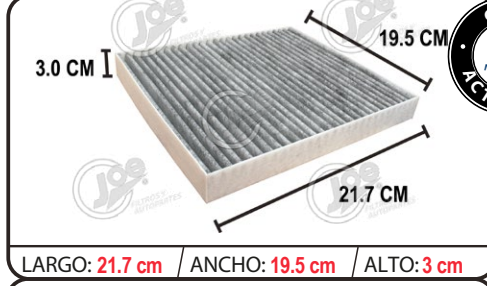

| RENAULT                              | JAC8438CA    |                 |
|--------------------------------------|--------------|-----------------|
| APLICACIÓN                           | EQUIVALENCIA |                 |
| SCALA MOD. 2010-2013 4 CIL. 2.0 LTS. | N/D          | <b>FRAM</b>     |
|                                      | N/D          | <b>INTERFIL</b> |
|                                      | N/D          | <b>WIX</b>      |



| RENAULT    | JAC9698CA    |                 |
|------------|--------------|-----------------|
| APLICACIÓN | EQUIVALENCIA |                 |
| KWID 2018  | N/D          | <b>FRAM</b>     |
|            | N/D          | <b>INTERFIL</b> |
|            | N/D          | <b>WIX</b>      |



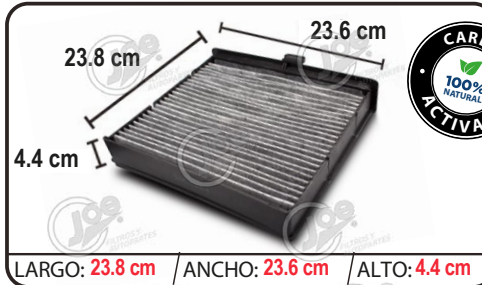

| RENAULT   |  | JAC1064CA    |          |
|---|--|--------------|----------|
| APLICACIÓN  |  | EQUIVALENCIA |          |
| SCENIC 2010-2015 4C 1.6L / SCENIC 2010-2015 4C 2.0L / |  | N/D          | FRAM     |
|   |  | CFI-1064CA   | INTERFIL |
|   |  | N/D          | WIX      |

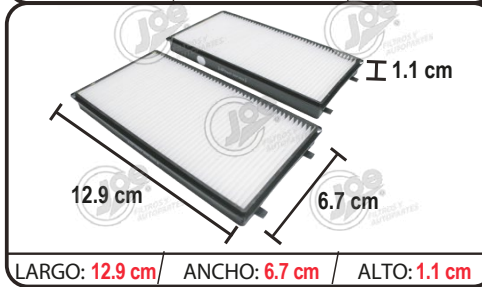

| ROLLS ROYCE                  |  | JAC10937     |          |
|------------------------------|--|--------------|----------|
| APLICACIÓN                   |  | EQUIVALENCIA |          |
| PHANTOM 2004-2013 12C 6.7L / |  |              | FRAM     |
|                              |  | N/D          | INTERFIL |
|                              |  | 49360        | WIX      |



| SAAB  |  | JAC1327      |          |
|---|--|--------------|----------|
| APLICACIÓN  |  | EQUIVALENCIA |          |
| 9-5 2000-2008 6C 2.8L / 9-4X 2011 4C 2.3L TURBO / 9-4X 2011 4C 3.0L / |  | CF10775      | FRAM     |
|   |  | CFI-1327     | INTERFIL |
|   |  | 24191        | WIX      |

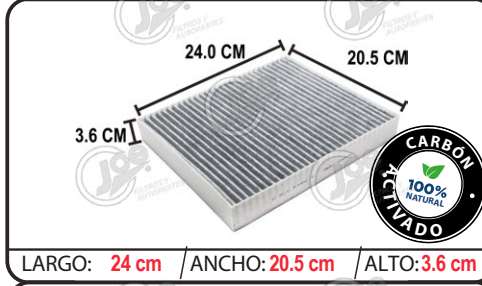

| SAAB  |  | JAC1327CA    |          |
|---|--|--------------|----------|
| APLICACIÓN  |  | EQUIVALENCIA |          |
| 9-5 2000-2008 6C 2.8L / 9-4X 2011 4C 2.3L TURBO / 9-4X 2011 4C 3.0L / |  | CF10775      | FRAM     |
|   |  | CFI-1327     | INTERFIL |
|   |  | 24191        | WIX      |

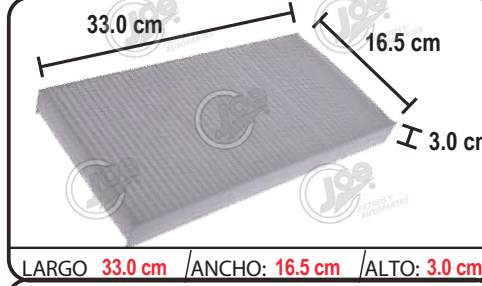

| SAAB   |  | JAC1808      |          |
|--|--|--------------|----------|
| APLICACIÓN   |  | EQUIVALENCIA |          |
| 9-3 2007-2010 6C 2.8L / 9-4 AERO 2007-2009 4C 2.0L / |  | 11669        | FRAM     |
|  |  | CFI-1808     | INTERFIL |
|  |  | 24472        | WIX      |

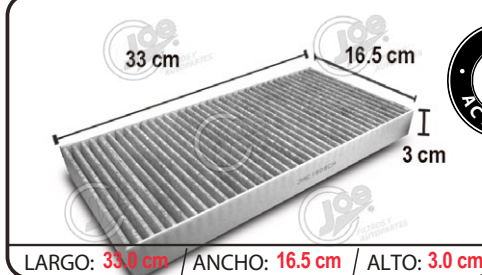

| SAAB   |  | JAC1808CA    |          |
|--|--|--------------|----------|
| APLICACIÓN   |  | EQUIVALENCIA |          |
| 9-3 2007-2010 6C 2.8L / 9-4 AERO 2007-2009 4C 2.0L / |  | 11669        | FRAM     |
|  |  | CFI-1808CA   | INTERFIL |
|  |  | 24472        | WIX      |

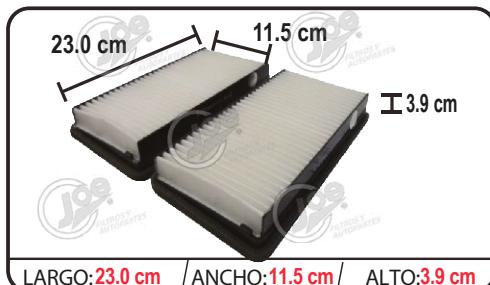

LARGO: 23.0 cm / ANCHO: 11.5 cm / ALTO: 3.9 cm

| SATURN  |  | JAC1030      |                 |
|---|--|--------------|-----------------|
| APLICACIÓN  |  | EQUIVALENCIA |                 |
| SV-6 MOD. 2007-2009 6 CIL. 3.5 LTS. / RELAY MOD. 2005-2007 6 CIL. 3.5 LTS. / RELAY MOD. 2005-2007 6 CIL. 3.9 LTS. |  | CF10136      | <b>FRAM</b>     |
|   |  | CFI-1030     | <b>INTERFIL</b> |
|   |  | 24161        | <b>WIX</b>      |

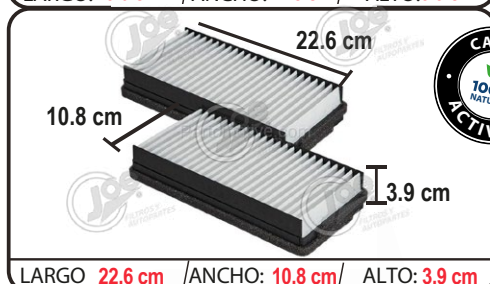

LARGO 22.6 cm / ANCHO: 10.8 cm / ALTO: 3.9 cm

| SATURN  |  | JAC1030CA    |                 |
|---|--|--------------|-----------------|
| APLICACIÓN  |  | EQUIVALENCIA |                 |
| SV-6 MOD. 2007-2009 6 CIL. 3.5 LTS. / RELAY MOD. 2005-2007 6 CIL. 3.5 LTS. / RELAY MOD. 2005-2007 6 CIL. 3.9 LTS. |  | CF10136      | <b>FRAM</b>     |
|   |  | CFI-1030     | <b>INTERFIL</b> |
|   |  | 24161        | <b>WIX</b>      |



LARGO: 42.3 cm / ANCHO: 11.0 cm / ALTO: 3.1 cm

| SATURN  |  | JAC2272CA    |                 |
|---|--|--------------|-----------------|
| APLICACIÓN  |  | EQUIVALENCIA |                 |
| GREEN LINE 2007 4C 2.4L / VUE 2002-2007 4C 2.2L / VUE 2002 6C3.0L / VUE 2004-2007 6C 3.5L / VUE HIBRID 2007 4C 2.4L / |  | CF10141      | <b>FRAM</b>     |
|   |  | CFI-2272     | <b>INTERFIL</b> |
|   |  | 24872        | <b>WIX</b>      |

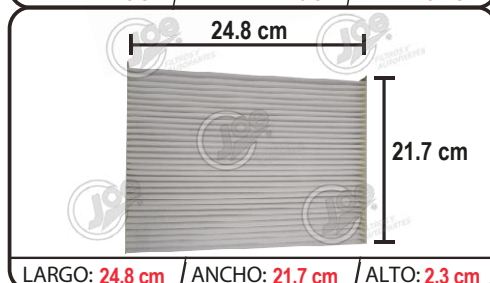

LARGO: 24.8 cm / ANCHO: 21.7 cm / ALTO: 2.3 cm

| SATURN   |  | JAC5249      |                 |
|--|--|--------------|-----------------|
| APLICACIÓN   |  | EQUIVALENCIA |                 |
| ION 2004-2007 4C 2.0 L / ION 2003-2007 4C 2.2L / ION 2006-2007 4C 2.4L / RED 2004-2007 4C 2.0L / RED 4C 2.2L / SATTURN RED 2006-2007 4C 2.4L / |  | CF10361      | <b>FRAM</b>     |
|  |  | CFI-5249     | <b>INTERFIL</b> |
|  |  | 24811        | <b>WIX</b>      |

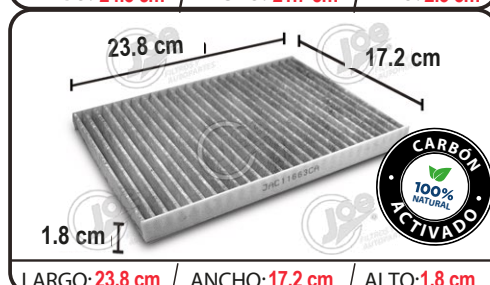

LARGO: 23.8 cm / ANCHO: 17.2 cm / ALTO: 1.8 cm

| SATURN                                |  | JAC11663CA   |                 |
|---------------------------------------|--|--------------|-----------------|
| APLICACIÓN                            |  | EQUIVALENCIA |                 |
| OUTLOOK MOD. 2007-2010 6 CIL. 3.6 LTS |  | CF11663      | <b>FRAM</b>     |
|                                       |  | CFI-11663    | <b>INTERFIL</b> |
|                                       |  | WP10074      | <b>WIX</b>      |



LARGO: 28.0 cm / ANCHO: 20.6 cm / ALTO: 2.6 cm

| SEAT  |  | JAC1H08      |                 |
|---|--|--------------|-----------------|
| APLICACIÓN  |  | EQUIVALENCIA |                 |
| IBIZA 2003-2013 4C 1.6L / TOLEDO 1999-2005 4C 1.8L / TOLEDO 1999-2005 4C 1.8L TURBO |  | CF8644       | <b>FRAM</b>     |
|   |  | CFI-1H08CA   | <b>INTERFIL</b> |
|   |  | 24322        | <b>WIX</b>      |

|   |   |  |          |      |            |          |       |     |
|---|---|--|----------|------|------------|----------|-------|-----|
|  <p>28 cm / 20 cm / 2.6 cm</p> <p>LARGO: 28.0 cm / ANCHO: 20.6 cm / ALTO: 2.6 cm</p>                                   | <p><b>SEAT</b></p> <p>APLICACIÓN</p> <p>IBIZA 2003-2013 4C 1.6L / TOLEDO 1999-2005 4C 1.8L / TOLEDO 1999-2005 4C 1.8L TURBO</p>   | <p><b>JAC1H08CA</b></p> <p>EQUIVALENCIA</p> <table border="1"> <tr><td>CF8644</td><td>FRAM</td></tr> <tr><td>CFI-1H08CA</td><td>INTERFIL</td></tr> <tr><td>24322</td><td>WIX</td></tr> </table>  | CF8644   | FRAM | CFI-1H08CA | INTERFIL | 24322 | WIX |
| CF8644  | FRAM  |  |          |      |            |          |       |     |
| CFI-1H08CA  | INTERFIL  |  |          |      |            |          |       |     |
| 24322   | WIX   |  |          |      |            |          |       |     |
|  <p>28.0 CM / 21.0 CM / 5.7 CM / 16.0 CM / 12.3 CM / 14.2 CM</p> <p>LARGO: 28.0 cm / ANCHO: 20.6 cm / ALTO: 2.6 cm</p> | <p><b>SEAT</b></p> <p>APLICACIÓN</p> <p>ALTEA 2013-2015 4C 1.8L TURBO / ALTEA 2006-2007 4C 2.0L / LEON 2008-2009 4C 2.0L / LEON CUPRA 2007-2014 4C 2.0L / LEON FR 4C 1.8L TURBO / LEON FR 4C 2.0L</p>   | <p><b>JAC1K28</b></p> <p>EQUIVALENCIA</p> <table border="1"> <tr><td>CF10373</td><td>FRAM</td></tr> <tr><td>CFI-1K28CA</td><td>INTERFIL</td></tr> <tr><td>24489</td><td>WIX</td></tr> </table>   | CF10373  | FRAM | CFI-1K28CA | INTERFIL | 24489 | WIX |
| CF10373   | FRAM  |  |          |      |            |          |       |     |
| CFI-1K28CA  | INTERFIL  |  |          |      |            |          |       |     |
| 24489   | WIX   |  |          |      |            |          |       |     |
|  <p>28.7 cm / 21.2 cm / 3.4 cm</p> <p>LARGO: 28.7 cm / ANCHO: 21.2 cm / ALTO: 3.4 cm</p>                              | <p><b>SEAT</b></p> <p>APLICACIÓN</p> <p>ALTEA 2013-2015 4C 1.8L TURBO / ALTEA 2006-2007 4C 2.0L / LEON 2008-2009 4C 2.0L / LEON CUPRA 2007-2014 4C 2.0L / LEON FR 4C 1.8L TURBO / LEON FR 4C 2.0L /</p>   | <p><b>JAC1K28CA</b></p> <p>EQUIVALENCIA</p> <table border="1"> <tr><td>CF10373</td><td>FRAM</td></tr> <tr><td>CFI-1K28CA</td><td>INTERFIL</td></tr> <tr><td>24489</td><td>WIX</td></tr> </table> | CF10373  | FRAM | CFI-1K28CA | INTERFIL | 24489 | WIX |
| CF10373   | FRAM  |  |          |      |            |          |       |     |
| CFI-1K28CA  | INTERFIL  |  |          |      |            |          |       |     |
| 24489   | WIX   |  |          |      |            |          |       |     |
|  <p>25.2 CM / 21.6 CM / 3.2 CM</p> <p>LARGO: 25.2 cm / ANCHO: 21.6 cm / ALTO: 3.2 cm</p>                             | <p><b>SEAT</b></p> <p>APLICACIÓN</p> <p>AZTECA 2017-2018 4C 2.0L TURBO / CORDOBA 2002-2013 4C 1.6L / CORDOBA 2003-2009 4C 2.0L / IBIZA 2003-2018 4C 1.6L / IBIZA 2003-2018 4C 2.0L / IBIZA CUPRA 2014-2018 4C 1.2L TURBO / IBIZA CUPRA 2014-2018 4C 1.4L / IBIZA DSG 2008-2009 4C 1.6L / IBIZA SPORT 2008-2009 4C 2.0L / LEON 2000-2006 4C 1.8L / LEON CUPRA 2015-2018 4C 2.0L / LEON STYLE 2015-2018 4C 1.4L TURBO / TOLEDO REFERENCE 2013-2018 4C 1.4C 1.8L /6L / IBIZA 2003-2013</p> | <p><b>JAC6Q08</b></p> <p>EQUIVALENCIA</p> <table border="1"> <tr><td>N/D</td><td>FRAM</td></tr> <tr><td>CFI-6Q08CA</td><td>INTERFIL</td></tr> <tr><td>24517</td><td>WIX</td></tr> </table>       | N/D      | FRAM | CFI-6Q08CA | INTERFIL | 24517 | WIX |
| N/D   | FRAM  |  |          |      |            |          |       |     |
| CFI-6Q08CA  | INTERFIL  |  |          |      |            |          |       |     |
| 24517   | WIX   |  |          |      |            |          |       |     |
|  <p>25.2 CM / 21.6 CM / 3.2 CM</p> <p>LARGO: 25.2 cm / ANCHO: 21.6 cm / ALTO: 3.2 cm</p>                             | <p><b>SEAT</b></p> <p>APLICACIÓN</p> <p>ATECA 2017-2018 4C 2.0L TURBO / CORDOBA 2002-2013 4C 1.6L / CORDOBA 2003-2009 4C 2.0L / IBIZA 2003-2018 4C 1.6L / IBIZA 2003-2018 4C 2.0L / IBIZA CUPRA 2014-2018 4C 1.2L TURBO / IBIZA CUPRA 2014-2018 4C 1.4L / IBIZA DSG 2008-2009 4C 1.6L / IBIZA SPORT 2008-2009 4C 2.0L / LEON 2000-2006 4C 1.8L / LEON CUPRA 2015-2018 4C 2.0L / LEON STYLE 2015-2018 4C 1.4L TURBO / TOLEDO REFERENCE 2013-2018 4C 1.4C 1.8L /6L / IBIZA 2003-2013</p>  | <p><b>JAC6Q08CA</b></p> <p>EQUIVALENCIA</p> <table border="1"> <tr><td>N/D</td><td>FRAM</td></tr> <tr><td>CFI-6Q08CA</td><td>INTERFIL</td></tr> <tr><td>24517</td><td>WIX</td></tr> </table>     | N/D      | FRAM | CFI-6Q08CA | INTERFIL | 24517 | WIX |
| N/D   | FRAM  |  |          |      |            |          |       |     |
| CFI-6Q08CA  | INTERFIL  |  |          |      |            |          |       |     |
| 24517   | WIX   |  |          |      |            |          |       |     |
|  <p>25.3 cm / 23.3 cm / 2.9 cm</p> <p>LARGO: 25.3 cm / ANCHO: 23.3 cm / ALTO: 2.9 cm</p>                             | <p><b>SEAT</b></p> <p>APLICACIÓN</p> <p>SEAT LEON III 2018</p>  | <p><b>JAC11643CA</b></p> <p>EQUIVALENCIA</p> <table border="1"> <tr><td>CFA11643</td><td>FRAM</td></tr> <tr><td>N/D</td><td>INTERFIL</td></tr> <tr><td>N/D</td><td>WIX</td></tr> </table>        | CFA11643 | FRAM | N/D        | INTERFIL | N/D   | WIX |
| CFA11643  | FRAM  |  |          |      |            |          |       |     |
| N/D   | INTERFIL  |  |          |      |            |          |       |     |
| N/D   | WIX   |  |          |      |            |          |       |     |

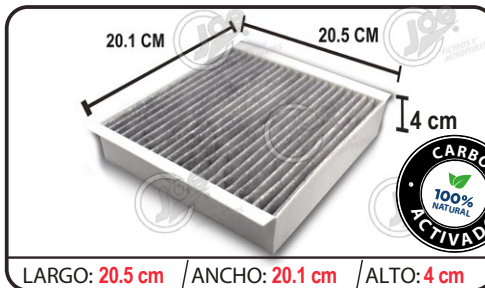

LARGO: 20.5 cm / ANCHO: 20.1 cm / ALTO: 4 cm

| SMART   |  | JAC1110CA    |          |
|---|--|--------------|----------|
| APLICACIÓN  |  | EQUIVALENCIA |          |
| CITY CABRIO MOD. 2003-2007 3 CIL. / CITY COUPE 2003-2007 3 CIL. |  | N/D          | FRAM     |
|   |  | CFI1110      | INTERFIL |
|   |  | 49261        | WIX      |

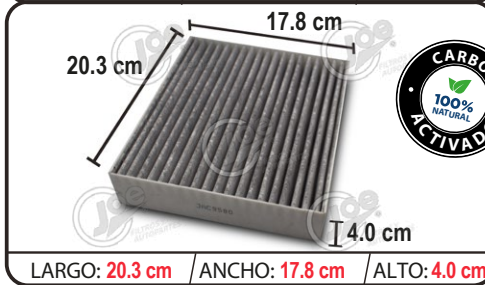

LARGO: 20.3 cm / ANCHO: 17.8 cm / ALTO: 4.0 cm

| SMART  |  | JAC9580CA    |          |
|--|--|--------------|----------|
| APLICACIÓN   |  | EQUIVALENCIA |          |
| FORFOUR MOD. 2004-2006 4 CIL. 1.1 LTS. / FORFOUR MOD. 2004-2006 4 CIL. 1.2 LTS. / ROADSTER MOD. 2003-2006 4 CIL. |  | N/D          | FRAM     |
|  |  | CFI9580CA    | INTERFIL |
|  |  | N/D          | WIX      |



LARGO: 21.5 cm / ANCHO: 21.4 cm / ALTO: 1.7 cm

| SUBARU   |  | JAC4701      |          |
|--|--|--------------|----------|
| APLICACIÓN   |  | EQUIVALENCIA |          |
| LEGACY 2005-2009 4C 2.5L / LEGACY 2005-2009 4C 2.5L TURBO / LEGACY 2008-2009 6C 3.0L / OUTBACK 2005-2009 4C 2.5L / OUTBACK 2005-2009 4C 2.5L TURBO / OUTBACK 2008-2009 6C 3.0L / TRIBECA 2006-2014 6C 3.0L / |  | CF9846A      | FRAM     |
|  |  | CFI-4701     | INTERFIL |
|  |  | 24875        | WIX      |

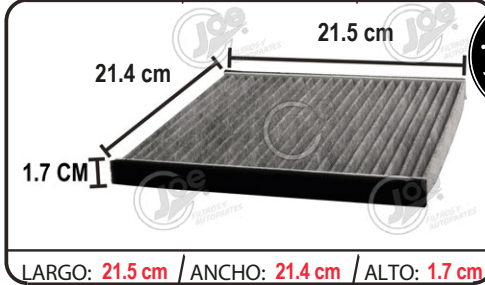

LARGO: 21.5 cm / ANCHO: 21.4 cm / ALTO: 1.7 cm

| SUBARU   |  | JAC4701CA    |          |
|--|--|--------------|----------|
| APLICACIÓN   |  | EQUIVALENCIA |          |
| LEGACY 2005-2009 4C 2.5L / LEGACY 2005-2009 4C 2.5L TURBO / LEGACY 2008-2009 6C 3.0L / OUTBACK 2005-2009 4C 2.5L / OUTBACK 2005-2009 4C 2.5L TURBO / OUTBACK 2008-2009 6C 3.0L / TRIBECA 2006-2014 6C 3.0L / |  | CF9846A      | FRAM     |
|  |  | CFI-4701     | INTERFIL |
|  |  | 24875        | WIX      |



LARGO: 22.2 cm / ANCHO: 21.3 cm / ALTO: 2 cm

| SUBARU   |  | JAC8713      |          |
|--|--|--------------|----------|
| APLICACIÓN   |  | EQUIVALENCIA |          |
| LEGACY 2005-2009 4C 2.5L / LEGACY 2005-2009 4C 2.5L TURBO / LEGACY 2008-2009 6C 3.0L / OUTBACK 2005-2009 4C 2.5L / OUTBACK 2005-2009 4C 2.5L / OUTBACK 2005-2009 6C 3.0L / TRIBECA 2006-2014 6C 3.0L / |  | CF10132      | FRAM     |
|  |  | CFI-8713     | INTERFIL |
|  |  | 24883        | WIX      |

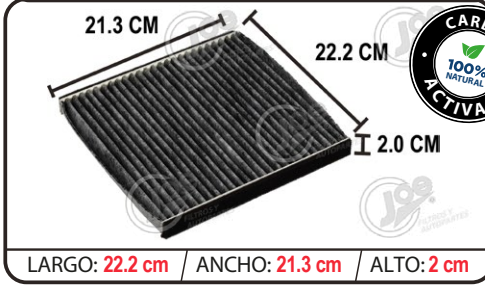

LARGO: 22.2 cm / ANCHO: 21.3 cm / ALTO: 2 cm

| SUBARU   |  | JAC8713CA    |          |
|--|--|--------------|----------|
| APLICACIÓN   |  | EQUIVALENCIA |          |
| LEGACY 2005-2009 4C 2.5L / LEGACY 2005-2009 4C 2.5L TURBO / LEGACY 2008-2009 6C 3.0L / OUTBACK 2005-2009 4C 2.5L / OUTBACK 2005-2009 4C 2.5L / OUTBACK 2005-2009 6C 3.0L / TRIBECA 2006-2014 6C 3.0L / |  | CF10132      | FRAM     |
|  |  | CFI-8713     | INTERFIL |
|  |  | 24883        | WIX      |



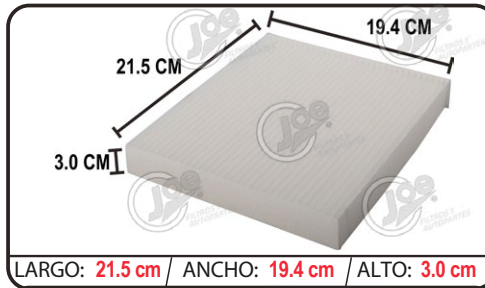

| SUBARU   |  | JAC8719       |          |
|--|--|---------------|----------|
| APLICACIÓN   |  | EQUIVALENCIA  |          |
| BRZ 2013-2015 4C 2.0L / LEGACY 2010-2014 4C 2.5L / LEGACY 2010-2012 4C 2.5L TURBO / LEGACY 2010-2014 6C 3.0L / OUTBACK 2010-2014 4C 2.5L / OUTBACK 2010-2014 6C 3.6L / |  | CF10285       | FRAM     |
|  |  | CFI-8719CA    | INTERFIL |
|  |  | 24488 / 24483 | WIX      |

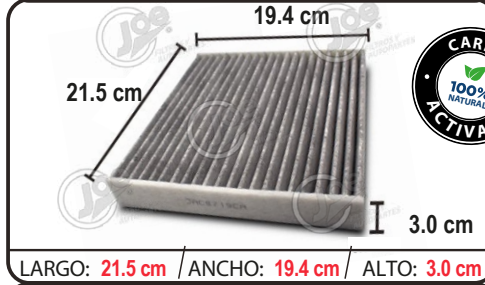

| SUBARU   |  | JAC8719CA    |          |
|--|--|--------------|----------|
| APLICACIÓN   |  | EQUIVALENCIA |          |
| BRZ 2013-2015 4C 2.0L / LEGACY 2010-2014 4C 2.5L / LEGACY 2010-2012 4C 2.5L TURBO / LEGACY 2010-2014 6C 3.0L / OUTBACK 2010-2014 4C 2.5L / OUTBACK 2010-2014 6C 3.6L / |  | CF10285      | FRAM     |
|  |  | CFI-8719CA   | INTERFIL |
|  |  |              | WIX      |

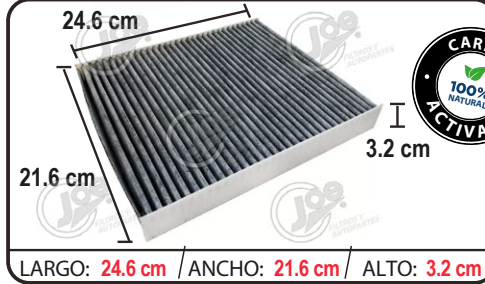

| SUBARU   |  | JAC12057     |          |
|--|--|--------------|----------|
| APLICACIÓN   |  | EQUIVALENCIA |          |
| ASCENT (2019-2021), CROSSTREK (2018-2021), IMPREZA (2017-2021) LEGACY (2020-2022), OUTBACK (2020-2022) |  | CFI-12157    | FRAM     |
|  |  |              | INTERFIL |
|  |  | WP10322      | WIX      |



| SUZUKI                          |  | JAC1827      |          |
|---------------------------------|--|--------------|----------|
| APLICACIÓN                      |  | EQUIVALENCIA |          |
| IGNIS 1.2 LTS. / SWIFT 1.4 LTS. |  | N/D          | FRAM     |
|                                 |  | N/D          | INTERFIL |
|                                 |  | N/D          | WIX      |



| SUZUKI                          |  | JAC1827CA    |          |
|---------------------------------|--|--------------|----------|
| APLICACIÓN                      |  | EQUIVALENCIA |          |
| IGNIS 1.2 LTS. / SWIFT 1.4 LTS. |  | N/D          | FRAM     |
|                                 |  | N/D          | INTERFIL |
|                                 |  | N/D          | WIX      |



| SUZUKI  |  | JAC2272CA    |          |
|---|--|--------------|----------|
| APLICACIÓN  |  | EQUIVALENCIA |          |
| XL-7 2007-2009 6C 3.0L / XL-7 2007-2009 6C 3.6L / |  | CF10141      | FRAM     |
|   |  | CFI-2272     | INTERFIL |
|   |  | 24872        | WIX      |

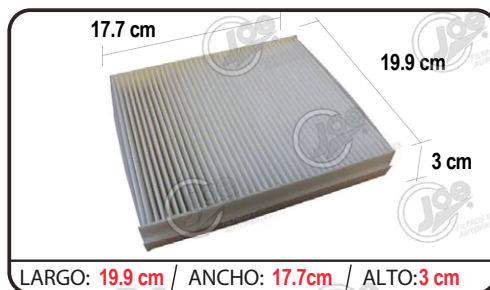

| SUZUKI                         | JAC7736      |          |
|--------------------------------|--------------|----------|
| APLICACIÓN                     | EQUIVALENCIA |          |
| SUZUKI SWIT 1.4 L. 1.6 L. 2010 | N/D          | FRAM     |
|                                | CFI-7736     | INTERFIL |
|                                | WP9280       | WIX      |

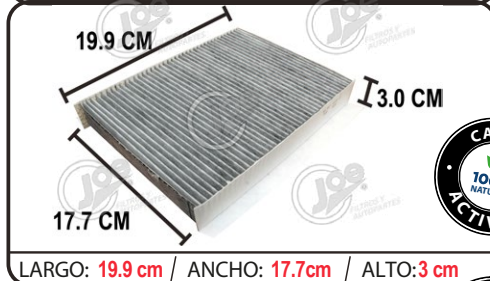

| SUZUKI                         | JAC7736CA    |          |
|--------------------------------|--------------|----------|
| APLICACIÓN                     | EQUIVALENCIA |          |
| SUZUKI SWIT 1.4 L. 1.6 L. 2010 | N/D          | FRAM     |
|                                | CFI-7736     | INTERFIL |
|                                | WP9280       | WIX      |

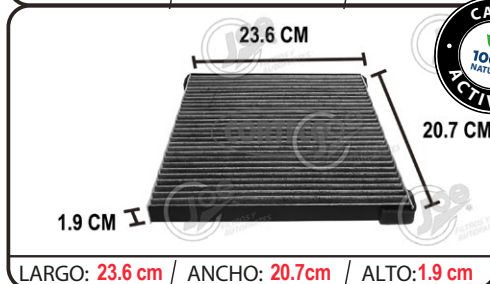

| SUZUKI                      | JAC8615CA    |          |
|-----------------------------|--------------|----------|
| APLICACIÓN                  | EQUIVALENCIA |          |
| KISASHI 2014-2016 4C 2.4L / | N/D          | FRAM     |
|                             | CFI-8615     | INTERFIL |
|                             | 24120        | WIX      |

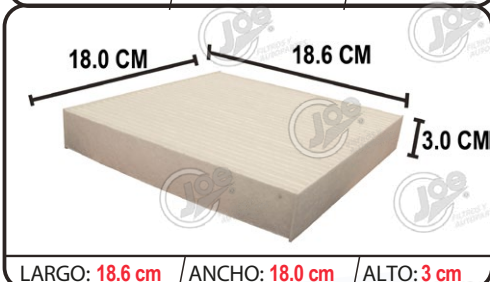

| SUZUKI  | JAC8617      |          |
|---|--------------|----------|
| APLICACIÓN  | EQUIVALENCIA |          |
| SWIFT 2014-2015 4C 1.4L / SWIFT 2014-2015 4C 1.6L /<br>VITARA 1999-2001 4C 1.6L / VITARA 1999-2004 4C 2.0L /<br>XL7 2001-2003 6C 2.7L / | N/D          | FRAM     |
|   | JAC8617      | INTERFIL |
|   | N/D          | WIX      |

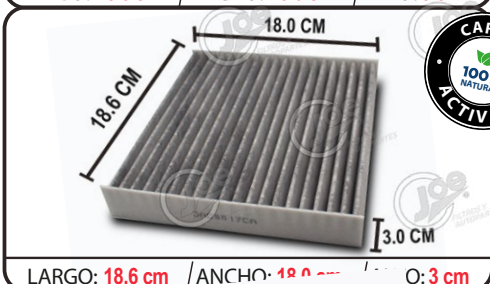

| SUZUKI  | JAC8617CA    |          |
|---|--------------|----------|
| APLICACIÓN  | EQUIVALENCIA |          |
| SWIFT 2014-2015 4C 1.4L / SWIFT 2014-2015 4C 1.6L /<br>VITARA 1999-2001 4C 1.6L / VITARA 1999-2004 4C 2.0L /<br>XL7 2001-2003 6C 2.7L / | N/D          | FRAM     |
|   | JAC8617CA    | INTERFIL |
|   | N/D          | WIX      |



| SUZUKI  | JAC8726CA    |          |
|---|--------------|----------|
| APLICACIÓN  | EQUIVALENCIA |          |
| GRAND VITARA 1999-2002 6C 2.5L / GRAND VITARA<br>2003 6C 2.7L / | CF8726A      | FRAM     |
|   | CFI-8726     | INTERFIL |
|   | 24899        | WIX      |

|  |   |   |         |             |             |                 |       |            |
|--|---|---|---------|-------------|-------------|-----------------|-------|------------|
|  <p>23.6 CM<br/>19.0 CM<br/>3.0 CM</p> <p><b>CARBÓN ACTIVADO</b><br/>100% NATURAL</p> <p>LARGO: 23.6 cm / ANCHO: 19 cm / ALTO: 3 cm</p>             | <p><b>SUZUKI</b></p> <p>APLICACIÓN</p> <p>S-CROSS 2.0 LTS. 4 CIL. MOD. 2015-2016</p>  | <p><b>JAC9585CA</b></p> <p>EQUIVALENCIA</p> <table border="1"> <tr><td>N/D</td><td><b>FRAM</b></td></tr> <tr><td>N/D</td><td><b>INTERFIL</b></td></tr> <tr><td>N/D</td><td><b>WIX</b></td></tr> </table>                | N/D     | <b>FRAM</b> | N/D         | <b>INTERFIL</b> | N/D   | <b>WIX</b> |
| N/D  | <b>FRAM</b>   |   |         |             |             |                 |       |            |
| N/D  | <b>INTERFIL</b>   |   |         |             |             |                 |       |            |
| N/D  | <b>WIX</b>  |   |         |             |             |                 |       |            |
|  <p>13.5 cm<br/>29.2 cm<br/>3 cm<br/>18.5 cm</p> <p><b>CARBÓN ACTIVADO</b><br/>100% NATURAL</p> <p>LARGO: 29.2 cm / ANCHO: 18.5 cm / ALTO: 3 cm</p> | <p><b>SUZUKI</b></p> <p>APLICACIÓN</p> <p>VERONA 2004-2006 6C 2.5L /</p>  | <p><b>JAC9629CA</b></p> <p>EQUIVALENCIA</p> <table border="1"> <tr><td>N/D</td><td><b>FRAM</b></td></tr> <tr><td>CFI-9629</td><td><b>INTERFIL</b></td></tr> <tr><td>24906</td><td><b>WIX</b></td></tr> </table>         | N/D     | <b>FRAM</b> | CFI-9629    | <b>INTERFIL</b> | 24906 | <b>WIX</b> |
| N/D  | <b>FRAM</b>   |   |         |             |             |                 |       |            |
| CFI-9629   | <b>INTERFIL</b>   |   |         |             |             |                 |       |            |
| 24906  | <b>WIX</b>  |   |         |             |             |                 |       |            |
|  <p>22.9 cm<br/>19.5 cm</p> <p>LARGO: 22.9 cm / ANCHO: 19.5 cm / ALTO: 2.5 cm</p>  | <p><b>SUZUKI</b></p> <p>APLICACIÓN</p> <p>FORENZA 2004-2008 4C 2.0L / RENO 2004-2008 4C 2.0L /</p>  | <p><b>JAC9655</b></p> <p>EQUIVALENCIA</p> <table border="1"> <tr><td>CF10557</td><td><b>FRAM</b></td></tr> <tr><td>CFI-9655</td><td><b>INTERFIL</b></td></tr> <tr><td>24902</td><td><b>WIX</b></td></tr> </table>       | CF10557 | <b>FRAM</b> | CFI-9655    | <b>INTERFIL</b> | 24902 | <b>WIX</b> |
| CF10557  | <b>FRAM</b>   |   |         |             |             |                 |       |            |
| CFI-9655   | <b>INTERFIL</b>   |   |         |             |             |                 |       |            |
| 24902  | <b>WIX</b>  |   |         |             |             |                 |       |            |
|  <p>22.9 cm<br/>20.5 cm<br/>2.5 cm</p> <p><b>CARBÓN ACTIVADO</b><br/>100% NATURAL</p> <p>LARGO: 22.9 cm / ANCHO: 20.5 cm / ALTO: 2.5 cm</p>       | <p><b>SUZUKI</b></p> <p>APLICACIÓN</p> <p>FORENZA 2004-2008 4C 2.0L / RENO 2004-2008 4C 2.0L /</p>  | <p><b>JAC9655CA</b></p> <p>EQUIVALENCIA</p> <table border="1"> <tr><td>CF10557</td><td><b>FRAM</b></td></tr> <tr><td>CFI-9655</td><td><b>INTERFIL</b></td></tr> <tr><td>24902</td><td><b>WIX</b></td></tr> </table>     | CF10557 | <b>FRAM</b> | CFI-9655    | <b>INTERFIL</b> | 24902 | <b>WIX</b> |
| CF10557  | <b>FRAM</b>   |   |         |             |             |                 |       |            |
| CFI-9655   | <b>INTERFIL</b>   |   |         |             |             |                 |       |            |
| 24902  | <b>WIX</b>  |   |         |             |             |                 |       |            |
|  <p>25.9 cm<br/>9.8 cm<br/>2.4 cm</p> <p>LARGO: 25.9 cm / ANCHO: 9.8 cm / ALTO: 2.4 cm</p>  | <p><b>SUZUKI</b></p> <p>APLICACIÓN</p> <p>SUZUKI EQUATOR MOD. 2009-2013 4 CIL. 2.5 LTS. /<br/>SUZUQUI EQUATOR MOD. 2009-2013 6 CIL. 4.0 LTS</p> | <p><b>JAC10553</b></p> <p>EQUIVALENCIA</p> <table border="1"> <tr><td>CF10553</td><td><b>FRAM</b></td></tr> <tr><td>CFI-10553CA</td><td><b>INTERFIL</b></td></tr> <tr><td>24683</td><td><b>WIX</b></td></tr> </table>   | CF10553 | <b>FRAM</b> | CFI-10553CA | <b>INTERFIL</b> | 24683 | <b>WIX</b> |
| CF10553  | <b>FRAM</b>   |   |         |             |             |                 |       |            |
| CFI-10553CA  | <b>INTERFIL</b>   |   |         |             |             |                 |       |            |
| 24683  | <b>WIX</b>  |   |         |             |             |                 |       |            |
|  <p>9.8 cm<br/>25.9 cm<br/>2.4 cm</p> <p><b>CARBÓN ACTIVADO</b><br/>100% NATURAL</p> <p>LARGO: 25.9 cm / ANCHO: 9.8 cm / ALTO: 2.4 cm</p>         | <p><b>SUZUKI</b></p> <p>APLICACIÓN</p> <p>SUZUKI EQUATOR MOD. 2009-2013 4 CIL. 2.5 LTS. /<br/>SUZUQUI EQUATOR MOD. 2009-2013 6 CIL. 4.0 LTS</p> | <p><b>JAC10553CA</b></p> <p>EQUIVALENCIA</p> <table border="1"> <tr><td>CF10553</td><td><b>FRAM</b></td></tr> <tr><td>CFI-10553CA</td><td><b>INTERFIL</b></td></tr> <tr><td>24683</td><td><b>WIX</b></td></tr> </table> | CF10553 | <b>FRAM</b> | CFI-10553CA | <b>INTERFIL</b> | 24683 | <b>WIX</b> |
| CF10553  | <b>FRAM</b>   |   |         |             |             |                 |       |            |
| CFI-10553CA  | <b>INTERFIL</b>   |   |         |             |             |                 |       |            |
| 24683  | <b>WIX</b>  |   |         |             |             |                 |       |            |



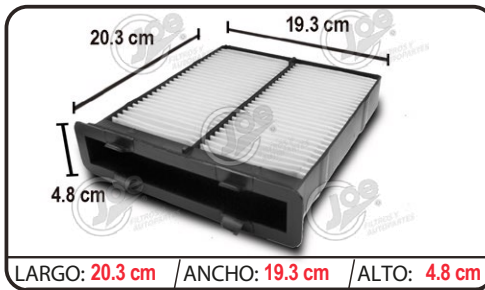

LARGO: 20.3 cm / ANCHO: 19.3 cm / ALTO: 4.8 cm

| SUZUKI                  |  | JAC10559     |                 |
|-------------------------|--|--------------|-----------------|
| APLICACIÓN              |  | EQUIVALENCIA |                 |
| SX4 2007-2013 4C 2.0L / |  | CF10559      | <b>FRAM</b>     |
|                         |  | CFI-10559    | <b>INTERFIL</b> |
|                         |  | 49700        | <b>WIX</b>      |

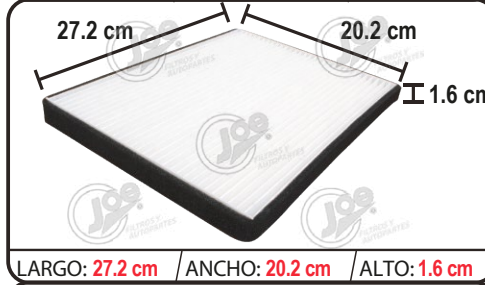

LARGO: 27.2 cm / ANCHO: 20.2 cm / ALTO: 1.6 cm

| SUZUKI   |  | JAC10731     |                 |
|--|--|--------------|-----------------|
| APLICACIÓN   |  | EQUIVALENCIA |                 |
| GRAND VITARA 2009-2015 4C 2.4L / GRAND VITARA 2006-2011 6C 2.7L / XL-7 2004-2006 6C 2.7L / |  | CF10731      | <b>FRAM</b>     |
|  |  | CFI-10731    | <b>INTERFIL</b> |
|  |  | 24200        | <b>WIX</b>      |

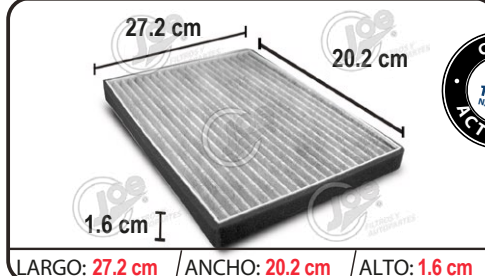

LARGO: 27.2 cm / ANCHO: 20.2 cm / ALTO: 1.6 cm

| SUZUKI   |  | JAC10731CA   |                 |
|--|--|--------------|-----------------|
| APLICACIÓN   |  | EQUIVALENCIA |                 |
| GRAND VITARA 2009-2015 4C 2.4L / GRAND VITARA 2006-2011 6C 2.7L / XL-7 2004-2006 6C 2.7L / |  | CF10731      | <b>FRAM</b>     |
|  |  | CFI-10731    | <b>INTERFIL</b> |
|  |  | 24200        | <b>WIX</b>      |

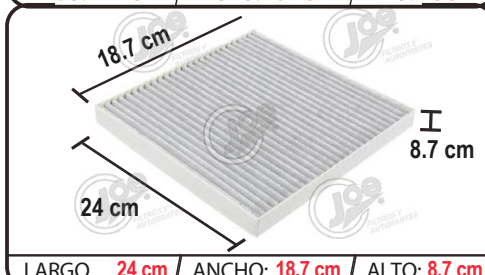

LARGO: 24 cm / ANCHO: 18.7 cm / ALTO: 8.7 cm

| TOYOTA   |  | JAC0211       |                 |
|--|--|---------------|-----------------|
| APLICACIÓN   |  | EQUIVALENCIA  |                 |
| TACOMA 2006-2015 4C 2.7L / TACOMA 2016-2018 6C 3.5L / TACOMA 2006-2015 6C 4.0L / |  | CF10374       | <b>FRAM</b>     |
|  |  | CFI-0211      | <b>INTERFIL</b> |
|  |  | 49358 / 24871 | <b>WIX</b>      |

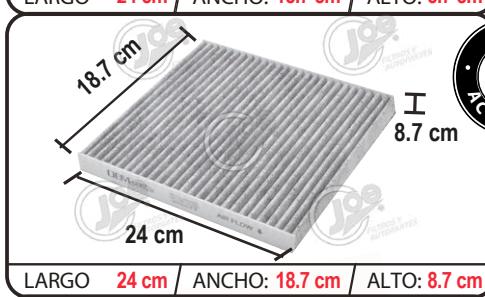

LARGO: 24 cm / ANCHO: 18.7 cm / ALTO: 8.7 cm

| TOYOTA   |  | JAC0211CA     |                 |
|--|--|---------------|-----------------|
| APLICACIÓN   |  | EQUIVALENCIA  |                 |
| TACOMA 2006-2015 4C 2.7L / TACOMA 2016-2018 6C 3.5L / TACOMA 2006-2015 6C 4.0L / |  | CF10374       | <b>FRAM</b>     |
|  |  | CFI-0211      | <b>INTERFIL</b> |
|  |  | 49358 / 24871 | <b>WIX</b>      |

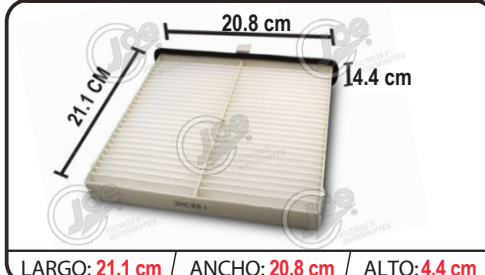

LARGO: 21.1 cm / ANCHO: 20.8 cm / ALTO: 4.4 cm

| TOYOTA                      |  | JAC961       |                 |
|-----------------------------|--|--------------|-----------------|
| APLICACIÓN                  |  | EQUIVALENCIA |                 |
| YARIS R 1.5 LTS 4 CIL. 2017 |  | N/D          | <b>FRAM</b>     |
|                             |  | N/D          | <b>INTERFIL</b> |
|                             |  | WP10267      | <b>WIX</b>      |



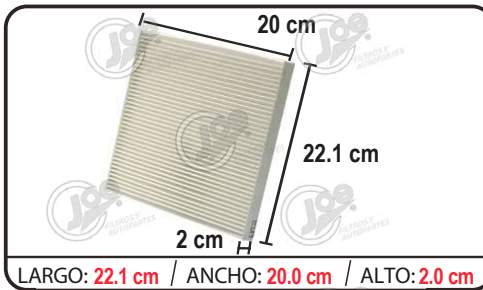

| TOYOTA  |  | JAC2020      |                 |
|---|--|--------------|-----------------|
| APLICACIÓN  |  | EQUIVALENCIA |                 |
| COROLLA 2003-2011 4C 1.8L / MATIX 2003-2010 4C 1.8L / |  | CF10133      | <b>FRAM</b>     |
|   |  | CFI-2020     | <b>INTERFIL</b> |
|   |  | 24873        | <b>WIX</b>      |

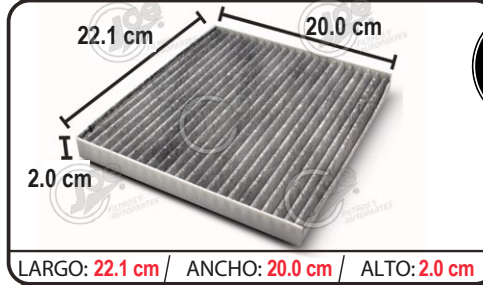

| TOYOTA  |  | JAC2020CA    |                 |
|---|--|--------------|-----------------|
| APLICACIÓN  |  | EQUIVALENCIA |                 |
| COROLLA 2003-2011 4C 1.8L / MATIX 2003-2010 4C 1.8L / |  | CF10133      | <b>FRAM</b>     |
|   |  | CFI-2020     | <b>INTERFIL</b> |
|   |  | 24873        | <b>WIX</b>      |

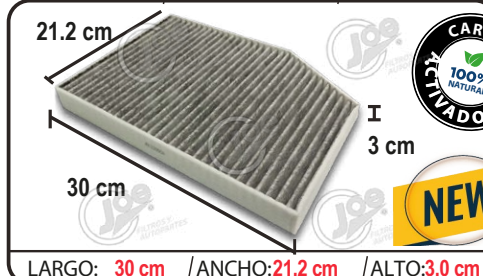

| TOYOTA  |  | JAC2205CA    |                 |
|---|--|--------------|-----------------|
| APLICACIÓN  |  | EQUIVALENCIA |                 |
| GR SUPRA 2.0L Y 3.0L 2018>2023 MANN CUK30007, MAHLE LAK1398, CORTECO 49428005 SAKURA CAC30130 |  | N/D          | <b>FRAM</b>     |
|   |  | N/D          | <b>INTERFIL</b> |
|   |  | WP2205       | <b>WIX</b>      |



| TOYOTA  |  | JAC4701      |                 |
|---|--|--------------|-----------------|
| APLICACIÓN  |  | EQUIVALENCIA |                 |
| 4 RUNNER 2003-2009 6C 4.0L / 4 RUNNER 2003-2009 2003-2009 8C 4.7L / AVALON 2000-2004 6C 3.0L / CAMRY 2002-2006 4C 2.4L / CAMRY 2002-2006 6C 3.0L / CELICA 2000-2005 4C 1.8L / FJ CRUSIER 2007-2014 4C 1.8L / TOYOTAPRIUS HIBRIDO 2001-2009 4C 1.5L / SIENNA 2004-2010 6C 3.3L / SOLARA 2004-2008 4C 2.4L / SOLARA 2004-2008 6C 3.3L / |  | CF9846A      | <b>FRAM</b>     |
|   |  | CFI-4701     | <b>INTERFIL</b> |
|   |  | 24875        | <b>WIX</b>      |



| TOYOTA  |  | JAC4701CA    |                 |
|---|--|--------------|-----------------|
| APLICACIÓN  |  | EQUIVALENCIA |                 |
| 4 RUNNER 2003-2009 6C 4.0L / 4 RUNNER 2003-2009 2003-2009 8C 4.7L / AVALON 2000-2004 6C 3.0L / CAMRY 2002-2006 4C 2.4L / CAMRY 2002-2006 6C 3.0L / CELICA 2000-2005 4C 1.8L / FJ CRUSIER 2007-2014 4C 1.8L / TOYOTAPRIUS HIBRIDO 2001-2009 4C 1.5L / SIENNA 2004-2010 6C 3.3L / SOLARA 2004-2008 4C 2.4L / SOLARA 2004-2008 6C 3.3L / |  | CF9846A      | <b>FRAM</b>     |
|   |  | CFI-4701     | <b>INTERFIL</b> |
|   |  | 24875        | <b>WIX</b>      |





| TOYOTA  |  | JAC8713      |                 |
|---|--|--------------|-----------------|
| APLICACIÓN  |  | EQUIVALENCIA |                 |
| CAMRY LE, XLE 2.4 L. 4 CIL. 2002-2009 / YARIS 1.3 L, 4 CIL. 2003-2005 / SIENNA 3.5 L. V6 2008-20096 |  | CF10132      | <b>FRAM</b>     |
|   |  | CFI-8713     | <b>INTERFIL</b> |
|   |  |              | <b>WIX</b>      |

|  |  |  |
|--|--|--|
|  <p>21.3 CM<br/>22.2 CM<br/>2.0 CM</p> <p><b>CARBÓN ACTIVADO</b><br/>100% NATURAL</p> | <p><b>TOYOTA</b></p> <p><b>APLICACIÓN</b></p> <p>CAMRY LE, XLE 2.4 L. 4 CIL. 2002-2009 / YARIS 1.3 L, 4 CIL. 2003-2005 / SIENNA 3.5 L. V6 2008-20096</p> | <p><b>JAC8713CA</b></p> <p><b>EQUIVALENCIA</b></p> <p>CF9846 <b>FRAM</b></p> <p>CFI-8713 <b>INTERFIL</b></p> <p>24875 <b>WIX</b></p> |
|  | <p>LARGO: 22.2 cm / ANCHO: 21.3 cm / ALTO: 2 cm</p>  |  |

|   |  |   |
|---|--|---|
|  <p>21.5 CM<br/>19.4 CM<br/>3.0 CM</p> | <p><b>TOYOTA</b></p> <p><b>APLICACIÓN</b></p> <p>4 RUNNER 2010-2011 4C 2.7L / 4 RUNNER 2010-2019 6C 4.0L / AVALON 2005-2014 6C 3.5L / AVALON HIBRIDO 2013-2014 4C 2.5L / CAMRY 2007-2009 4C 2.4L / CAMRY 2010-2017 4C 2.5L / CAMRY 2007-2017 6C 3.5L / CAMRY HIBRIDO 2007-2011 4C 2.4L / CAMRY HIBRIDO 2007-2011 4C 2.5L / COROLLA 2009-2011 4C 2.4L / HIACE 2014-2016 4C 2.7L / HIGHLANDER 2009-2015 4C 2.7L / HIGHLANDER 2008-2019 6C 3.5L / HIGHLANDER HIBRIDO 2008-2013 6C 3.3L / LAND CRUISER 2008-2019 8C 5.7L / MATRIX 2011-2013 4C 1.8L / PRIUS HIBRIDO 2012-2015 4C 1.5L / PRIUS HIBRIDO 2011-2019 4C 1.8L / RAV4 2006-2008 4C 2.4L / RAV4 2009-2018 4C 2.5L / RAV4 2006-2012 6C 3.5L / SEQUOIA 2010-2012 8C 4.6L / SEQUOIA 2008-2009 8C 4.7L / SEQUOIA 2009-2017 8C 5.7L / SIENNA 2011-2013 4C 2.7L / SIENNA 2011-2019 6C 3.5L / TUNDRA 2007-2013 6C 4.0L / TUNDRA 2010-2013 8C 4.6L / TUNDRA 2007-2009 8C 4.7L / TUNDRA 2007-2019 8C 5.7L / VENZA 2009-2015 4C 2.7L / VENZA 2009-2015 6C 3.5L / YARIS 2007-2016 4C 1.5L /</p> | <p><b>JAC8719</b></p> <p><b>EQUIVALENCIA</b></p> <p>CF10285 <b>FRAM</b></p> <p>CFI-8719CA <b>INTERFIL</b></p> <p>24488 / 24483 <b>WIX</b></p> |
|   | <p>LARGO: 21.5 cm / ANCHO: 19.4 cm / ALTO: 3.0 cm</p>  |   |

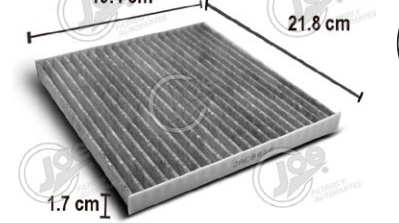
|   |  |   |
|---|--|---|
|  <p>21.5 cm<br/>19.4 cm<br/>3.0 cm</p> <p><b>CARBÓN ACTIVADO</b><br/>100% NATURAL</p> | <p><b>TOYOTA</b></p> <p><b>APLICACIÓN</b></p> <p>4 RUNNER 2010-2011 4C 2.7L / 4 RUNNER 2010-2019 6C 4.0L / AVALON 2005-2014 6C 3.5L / AVALON HIBRIDO 2013-2014 4C 2.5L / CAMRY 2007-2009 4C 2.4L / CAMRY 2010-2017 4C 2.5L / CAMRY 2007-2017 6C 3.5L / CAMRY HIBRIDO 2007-2011 4C 2.4L / CAMRY HIBRIDO 2007-2011 4C 2.5L / COROLLA 2009-2011 4C 2.4L / HIACE 2014-2016 4C 2.7L / HIGHLANDER 2009-2015 4C 2.7L / HIGHLANDER 2008-2019 6C 3.5L / HIGHLANDER HIBRIDO 2008-2013 6C 3.3L / LAND CRUISER 2008-2019 8C 5.7L / MATRIX 2011-2013 4C 1.8L / PRIUS HIBRIDO 2012-2015 4C 1.5L / PRIUS HIBRIDO 2011-2019 4C 1.8L / RAV4 2006-2008 4C 2.4L / RAV4 2009-2018 4C 2.5L / RAV4 2006-2012 6C 3.5L / SEQUOIA 2010-2012 8C 4.6L / SEQUOIA 2008-2009 8C 4.7L / SEQUOIA 2009-2017 8C 5.7L / SIENNA 2011-2013 4C 2.7L / SIENNA 2011-2019 6C 3.5L / TUNDRA 2007-2013 6C 4.0L / TUNDRA 2010-2013 8C 4.6L / TUNDRA 2007-2009 8C 4.7L / TUNDRA 2007-2019 8C 5.7L / VENZA 2009-2015 4C 2.7L / VENZA 2009-2015 6C 3.5L / YARIS 2007-2016 4C 1.5L /</p> | <p><b>JAC8719CA</b></p> <p><b>EQUIVALENCIA</b></p> <p>CF10285 <b>FRAM</b></p> <p>CFI-8719CA <b>INTERFIL</b></p> <p>24488 / 24483 <b>WIX</b></p> |
|   | <p>LARGO: 21.5 cm / ANCHO: 19.4 cm / ALTO: 3.0 cm</p>  |   |

|  |  |   |
|--|--|---|
|  <p>19.4 cm<br/>21.8 cm<br/>1.7 cm</p> <p><b>CARBÓN ACTIVADO</b><br/>100% NATURAL</p> | <p><b>TOYOTA</b></p> <p><b>APLICACIÓN</b></p> <p>RAV4 2001-2003 4C 2.0L / RAV4 2004-2005 4C 2.4L /</p> | <p><b>JAC8856CA</b></p> <p><b>EQUIVALENCIA</b></p> <p>CF10139 <b>FRAM</b></p> <p>CFI-8856 <b>INTERFIL</b></p> <p>24900 <b>WIX</b></p> |
|  | <p>LARGO: 21.8 cm / ANCHO: 19.4 cm / ALTO: 1.7 cm</p>  |   |

|   |   |   |
|---|---|---|
|  <p>21.6 cm<br/>18.6 cm<br/>3 cm</p> | <p><b>TOYOTA</b></p> <p><b>APLICACIÓN</b></p> <p>AVALON (2019-2021), CAMRY (2018-2021), COROLLA (2019-2021) HIGHLANDER (2020-2021), PRIUS (2016-2021), PRIUS AWD-E (2019-2021), PRIUS PRIME (2017-2021), RAV4 (2019-2021), RAV4 PRIME (2021), SIENNA (2021-2022), VENZA (2021-2022)</p> | <p><b>JAC12157</b></p> <p><b>EQUIVALENCIA</b></p> <p>CF12157 <b>FRAM</b></p> <p><b>INTERFIL</b></p> <p>WP10322 <b>WIX</b></p> |
|   | <p>LARGO 21.6 cm / ANCHO: 18.6 cm / ALTO: 3 cm</p>  |   |

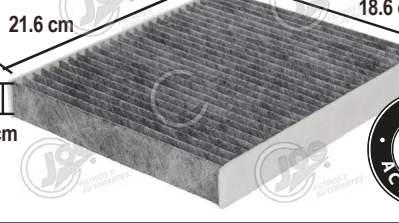
|  |   |   |
|--|---|---|
|  <p>21.6 cm<br/>18.6 cm<br/>3 cm</p> <p><b>CARBÓN ACTIVADO</b><br/>100% NATURAL</p> | <p><b>TOYOTA</b></p> <p><b>APLICACIÓN</b></p> <p>TOYOTA, CAMRY, PRIUS, RAV4, VENZA, AVALON, HIGHLANDER, C-HR Y COROLLA 4 Y V6 CIL. 1.8L, 2.0L, 3.5L 2018 - 2022</p> | <p><b>JAC12157CA</b></p> <p><b>EQUIVALENCIA</b></p> <p>CF12157 <b>FRAM</b></p> <p>CFI-12157CA <b>INTERFIL</b></p> <p>WP10322 <b>WIX</b></p> |
|  | <p>LARGO 21.6 cm / ANCHO: 18.6 cm / ALTO: 3 cm</p>  |   |



| <b>VOLKSWAGEN</b>                           |  | <b>JAC1508</b> |                 |
|---|--|----------------|-----------------|
| APLICACIÓN                                  |  | EQUIVALENCIA   |                 |
| VOLKSWAGEN UP MOD. 2016-2018 3 CIL. 1.0 LTS |  | N/D            | <b>FRAM</b>     |
|   |  | N/D            | <b>INTERFIL</b> |
|   |  | N/D            | <b>WIX</b>      |

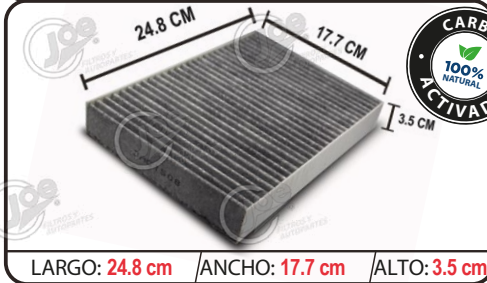

| <b>VOLKSWAGEN</b>                           |  | <b>JAC1508CA</b> |                 |
|---|--|------------------|-----------------|
| APLICACIÓN                                  |  | EQUIVALENCIA     |                 |
| VOLKSWAGEN UP MOD. 2016-2018 3 CIL. 1.0 LTS |  | N/D              | <b>FRAM</b>     |
|   |  | N/D              | <b>INTERFIL</b> |
|   |  | N/D              | <b>WIX</b>      |



| <b>VOLKSWAGEN</b>  |  | <b>JAC3570CA</b> |                 |
|--|--|------------------|-----------------|
| APLICACIÓN   |  | EQUIVALENCIA     |                 |
| PASSAT 1993 4C 1.9L TURBO DIESEL / PASSAT 1991-1993 4C 2.0L / PASSAT 1991-1993 N6C 2.0L / PASSAT 6C 2.8L / |  | N/D              | <b>FRAM</b>     |
|  |  | CFI-3570         | <b>INTERFIL</b> |
|  |  | 24779            | <b>WIX</b>      |

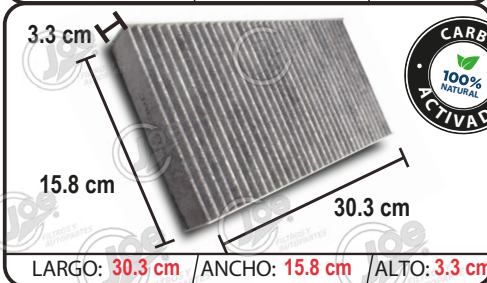

| <b>VOLKSWAGEN</b>               |  | <b>JAC3778CA</b> |                 |
|---------------------------------|--|------------------|-----------------|
| APLICACIÓN                      |  | EQUIVALENCIA     |                 |
| POINTER GTI 2004-2008 4C 2.0L / |  | N/D              | <b>FRAM</b>     |
|                                 |  | CFI-3778         | <b>INTERFIL</b> |
|                                 |  | N/D              | <b>WIX</b>      |

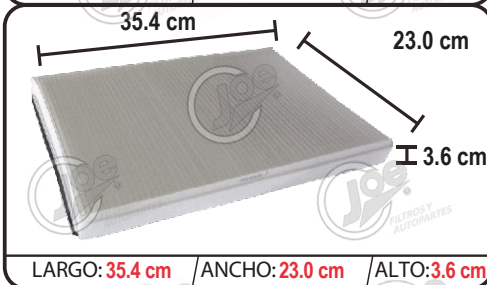

| <b>VOLKSWAGEN</b>   |  | <b>JAC9068</b> |                 |
|---|--|----------------|-----------------|
| APLICACIÓN  |  | EQUIVALENCIA   |                 |
| CRAFTER 30 2006-2008 5C 2.5 L TURBO DIESEL / CRAFTER 35 2006-2008 5C 2.5L TURBO DIESEL / CRAFTER 50 (2E) 2006-2008 5C 2.5L TURBO DIESEL / |  | PA10436        | <b>FRAM</b>     |
|   |  | CFI-9068CA     | <b>INTERFIL</b> |
|   |  | 49366          | <b>WIX</b>      |

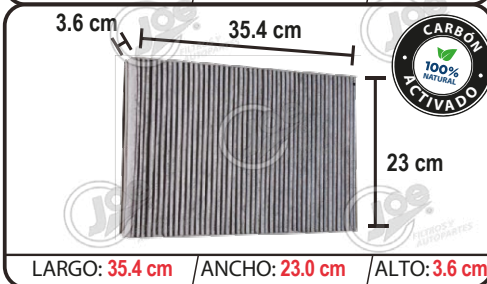

| <b>VOLKSWAGEN</b>   |  | <b>JAC9068CA</b> |                 |
|---|--|------------------|-----------------|
| APLICACIÓN  |  | EQUIVALENCIA     |                 |
| CRAFTER 30 2006-2008 5C 2.5 L TURBO DIESEL / CRAFTER 35 2006-2008 5C 2.5L TURBO DIESEL / CRAFTER 50 (2E) 2006-2008 5C 2.5L TURBO DIESEL / |  | PA10436          | <b>FRAM</b>     |
|   |  | CFI-9068CA       | <b>INTERFIL</b> |
|   |  | 49366            | <b>WIX</b>      |

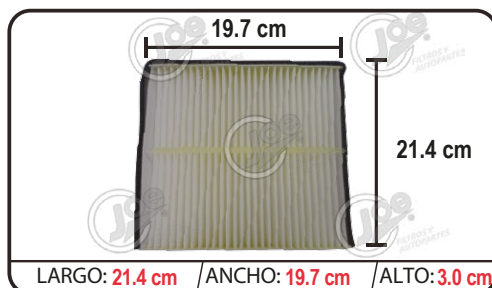

**VOLKSWAGEN**

**JAC10743**

APLICACIÓN

EQUIVALENCIA

ROUTAN MOD. 2009-2010 6 CIL. 3.6, 3.8, 4.0 LTS.

|           |                 |
|-----------|-----------------|
| CF10743   | <b>FRAM</b>     |
| CFI-10743 | <b>INTERFIL</b> |
| 24479     | <b>WIX</b>      |

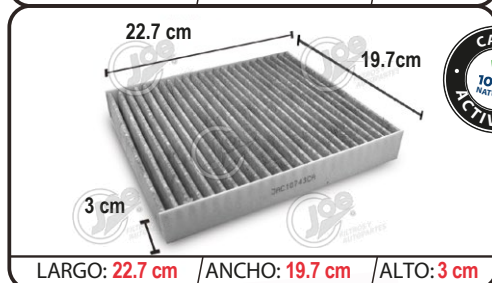

**VOLKSWAGEN**

**JAC10743CA**

APLICACIÓN

EQUIVALENCIA

ROUTAN MOD. 2009-2010 6 CIL. 3.6, 3.8, 4.0 LTS.

|           |                 |
|-----------|-----------------|
| CF10743   | <b>FRAM</b>     |
| CFI-10743 | <b>INTERFIL</b> |
| 24479     | <b>WIX</b>      |

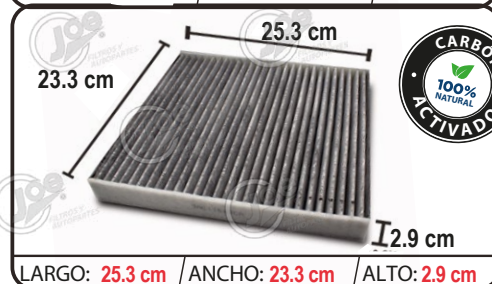

**VOLKSWAGEN**

**JAC11643CA**

APLICACIÓN

EQUIVALENCIA

CRAFTER 2018

|          |                 |
|----------|-----------------|
| CFA11643 | <b>FRAM</b>     |
| N/D      | <b>INTERFIL</b> |
| N/D      | <b>WIX</b>      |

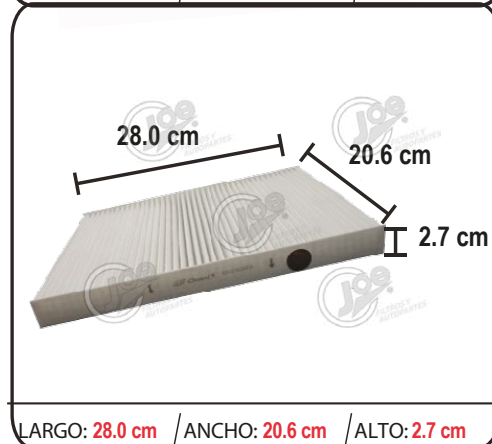

**VOLKSWAGEN**

**JAC1H08**

APLICACIÓN

EQUIVALENCIA

BEETLE 2006-2010 5C 2.5L / DERBY 1995-2002 4C 1.8L / DERBY 2002-2007 4C 2.0L / GOLF 1993-1994 4C 1.8L / GOLF 1993-1994 4C 1.8L TURBO / GOLF 1993-2003 4C 2.0L / GOLF 4C 2.8L / GOLF 1995-2005 6C 2.8L / GOLF GTI 1993 4C 2.0L / JETTA 2000-2007 4C 2.0L / JETTA GLI 2000-2005 4C 1.8L TURBO / JETTA GLI 2001-2005 4C 2.0L / JETTA VR6 1996-2004 6C 2.8L / PASSAT 2002-2005 4C 1.8L TURBO / PASSAT 2002-2005 6C 2.8L / PASSAT 2002-2004 8C 4.0L / PASSAT WAGON VR6 1997-1998 6C 2.8L / VAN 2003-2004 4C 1.8L /

|          |                 |
|----------|-----------------|
| CF8644   | <b>FRAM</b>     |
| CFI-1H08 | <b>INTERFIL</b> |
|          | <b>WIX</b>      |

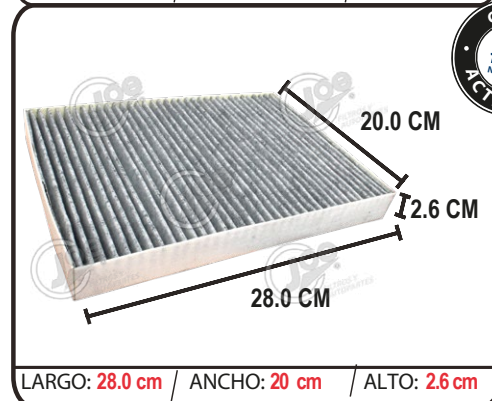

**VOLKSWAGEN**

**JAC1H08CA**

APLICACIÓN

EQUIVALENCIA

BEETLE 2006-2010 5C 2.5L / DERBY 1995-2002 4C 1.8L / DERBY 2002-2007 4C 2.0L / GOLF 1993-1994 4C 1.8L / GOLF 1993-1994 4C 1.8L TURBO / GOLF 1993-2003 4C 2.0L / GOLF 4C 2.8L / GOLF 1995-2005 6C 2.8L / GOLF GTI 1993 4C 2.0L / JETTA 2000-2007 4C 2.0L / JETTA GLI 2000-2005 4C 1.8L TURBO / JETTA GLI 2001-2005 4C 2.0L / JETTA VR6 1996-2004 6C 2.8L / PASSAT 2002-2005 4C 1.8L TURBO / PASSAT 2002-2005 6C 2.8L / PASSAT 2002-2004 8C 4.0L / PASSAT WAGON VR6 1997-1998 6C 2.8L / VAN 2003-2004 4C 1.8L /

|          |                 |
|----------|-----------------|
| CF8644   | <b>FRAM</b>     |
| CFI-1H08 | <b>INTERFIL</b> |
| 24322    | <b>WIX</b>      |



LARGO: 28.0 cm / ANCHO: 20.6 cm / ALTO: 3 cm

| VOLKSWAGEN   |  | JAC1J08CA    |                 |
|--|--|--------------|-----------------|
| APLICACIÓN   |  | EQUIVALENCIA |                 |
|  <p>BEETLE 2001-2005 4C 2.0 L TURBO / BEETLE 2000-2005 4C 1.8L / BEETLE 2006-2010 5C 2.5L / CABRIO 2000-2002 4C 2.0L / GOLF GTI 2001-2006 4C 1.8L / JETTA 2001-2005 4C 1.8L TURBO / JETTA 2005-2006 4C 1.9L / JETTA 2005-2007 4C 1.9L TURBO / JETTA 2000-2005 4C 2.0L / JETTA 1996-2004 V6 2.8L / PASSAT 2002-2005 4C 1.8L / PASSAT 2004-2005 4C 2.0L TURBO DIESEL / PASSAT 2002-2005 V6 2.8L /</p> |  | CF8644       | <b>FRAM</b>     |
|  |  | CFI-1J08C    | <b>INTERFIL</b> |
|  |  | 24322H       | <b>WIX</b>      |

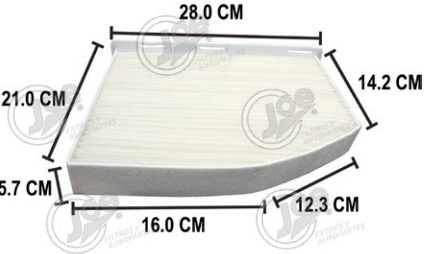

LARGO: 28 cm / ANCHO: 21 cm / ALTO: 5.7 cm

| VOLKSWAGEN   |  | JAC1K28      |                 |
|--|--|--------------|-----------------|
| APLICACIÓN   |  | EQUIVALENCIA |                 |
| <p>BEETLE 2014-2015 4C 1.8L TURBO / BEETLE 2012-2018 4C 2.0L TURBO / BEETLE 2012-2018 5C 2.5L / BORA 2006-2009 5C 2.5L / BORA GLI 2006-2009 4C 2.0L TURBO / CADY 2015-2016 4C 2.0L TURBO / CC 2009-2016 4C 2.0L TURBO / CC 2009-2016 6C 3.6L / EOS 2007-2015 4C 2.0L TURBO / EOS 2007-2008 4C 2.0L TURBO DIESEL / EOS 2007-2008 6C 3.2L / GOLF 2013-2014 4C 1.4L TURBO / GOLF 2010-2015 5C 2.5L / GOLF GTI 2006-2014 4C 2.0L TURBO / GTI 2007-2009 4C 2.0L / JETTA 2016-2018 4C 2.0L / JETTA 2006-2015 4C 2.0 TURBO / JETTA 2005-5C 2.5L / JETTA GLI 4C 1.8L TURBO / JETTA HIBRIDO 2013-2014 4C 1.4L / PASSAT 2014-2015 4C 1.8L TURBO / PASSAT 2006-2010 4C 2.0L TURBO / PASSAT 2012-2018 5C 2.5L / PASSAT 2006-2018 6C 3.6L / TIGUAN 2014-2017 4C 1.4L TURBO / TIGUAN 2009-2017 4C 2.0L TURBO /</p> |  | CF10373      | <b>FRAM</b>     |
|  |  | CFI-1K28     | <b>INTERFIL</b> |
|  |  | 24489        | <b>WIX</b>      |

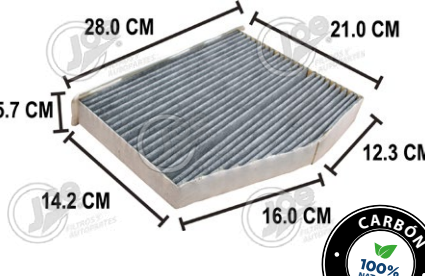

LARGO: 21 cm / ANCHO: 28 cm / ALTO: 5.7 cm

| VOLKSWAGEN   |  | JAC1K28CA    |                 |
|--|--|--------------|-----------------|
| APLICACIÓN   |  | EQUIVALENCIA |                 |
| <p>BEETLE 2014-2015 4C 1.8L TURBO / BEETLE 2012-2018 4C 2.0L TURBO / BEETLE 2012-2018 5C 2.5L / BORA 2006-2009 5C 2.5L / BORA GLI 2006-2009 4C 2.0L TURBO / CADY 2015-2016 4C 2.0L TURBO / CC 2009-2016 4C 2.0L TURBO / CC 2009-2016 6C 3.6L / EOS 2007-2015 4C 2.0L TURBO / EOS 2007-2008 4C 2.0L TURBO DIESEL / EOS 2007-2008 6C 3.2L / GOLF 2013-2014 4C 1.4L TURBO / GOLF 2010-2015 5C 2.5L / GOLF GTI 2006-2014 4C 2.0L TURBO / GTI 2007-2009 4C 2.0L / JETTA 2016-2018 4C 2.0L / JETTA 2006-2015 4C 2.0 TURBO / JETTA 2005-5C 2.5L / JETTA GLI 4C 1.8L TURBO / JETTA HIBRIDO 2013-2014 4C 1.4L / PASSAT 2014-2015 4C 1.8L TURBO / PASSAT 2006-2010 4C 2.0L TURBO / PASSAT 2012-2018 5C 2.5L / PASSAT 2006-2018 6C 3.6L / TIGUAN 2014-2017 4C 1.4L TURBO / TIGUAN 2009-2017 4C 2.0L TURBO /</p> |  | CF10373      | <b>FRAM</b>     |
|  |  | CFI-1K28     | <b>INTERFIL</b> |
|  |  | 24489        | <b>WIX</b>      |



LARGO: 25.2 cm / ANCHO: 21.6 cm / ALTO: 3.2 cm

| VOLKSWAGEN  |  | JAC6Q08      |                 |
|---|--|--------------|-----------------|
| APLICACIÓN  |  | EQUIVALENCIA |                 |
| <p>CADDY 2017-2018 4C 1.6L / CADDY 2017-2018 4C 1.6L TURBO / CROSSFOX 2007-2017 4C 1.6L / GOL 2009-2018 4C 1.6L / LUPO 2005-2009 4C 1.6L / POLO 2002-2018 4C 1.6L / POLO 2002-2012 4C 2.0L / POLO GTI 2015-2017 4C 1.8L TURBO / SAVEIRO 2010-2016 4C 1.6L / SPORT VAN 2007-2010 4C 1.8L / TIGUAN 2018-2019 4C 1.8L / TIGUAN 2018-2019 4C 2.0L TURBO / VENTO 2014-2019 4C 1.6L /</p> |  | N/D          | <b>FRAM</b>     |
|   |  | CFI-6Q08CA   | <b>INTERFIL</b> |
|   |  | 24517        | <b>WIX</b>      |





| VOLKSWAGEN   |  | JAC6Q08CA    |          |
|--|--|--------------|----------|
| APLICACIÓN   |  | EQUIVALENCIA |          |
| CADDY 2017-2018 4C 1.6L / CADDY 2017-2018 4C 1.6L TURBO / CROSSFOX 2007-2017 4C 1.6L / GOL 2009-2018 4C 1.6L / LUPO 2005-2009 4C 1.6L / POLO 2002-2018 4C 1.6L / POLO 2002-2012 4C 2.0L / POLO GTI 2015-2017 4C 1.8L TURBO / SAVEIRO 2010-2016 4C 1.6L / SPORT VAN 2007-2010 4C 1.8L / TIGUAN 2018-2019 4C 1.8L / TIGUAN 2018-2019 4C 2.0L TURBO / VENTO 2014-2019 4C 1.6L / |  | N/D          | FRAM     |
|  |  | CFI-6Q08CA   | INTERFIL |
|  |  | 24517        | WIX      |

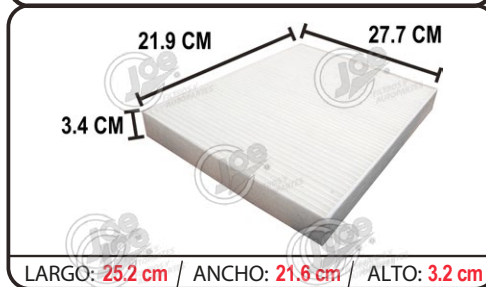

| VOLKSWAGEN   |  | JAC7H08      |          |
|--|--|--------------|----------|
| APLICACIÓN   |  | EQUIVALENCIA |          |
| AMAROK MOD. 2010-2018 4 CIL 2.0 LTS. TURBO DIESEL / TOUAREG MOD. 2004-2010 8 CIL. 4.7 LTS. / |  | CF9881       | FRAM     |
|  |  | CFI-7H08     | INTERFIL |
|  |  | 24631        | WIX      |



| VOLKSWAGEN   |  | JAC7H08CA    |          |
|--|--|--------------|----------|
| APLICACIÓN   |  | EQUIVALENCIA |          |
| AMAROK MOD. 2010-2018 4 CIL 2.0 LTS. TURBO DIESEL / TOUAREG MOD. 2004-2010 8 CIL. 4.7 LTS. / |  | CF9881       | FRAM     |
|  |  | CFI-7H08     | INTERFIL |
|  |  | 24631        | WIX      |

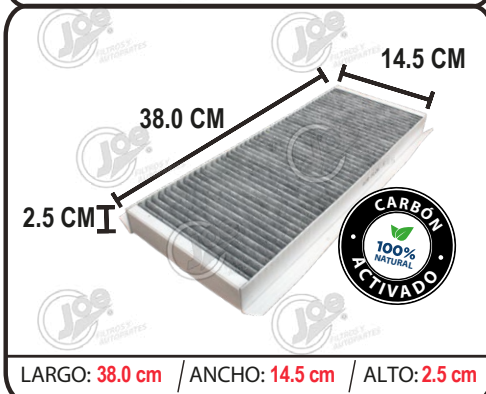

| VOLKSWAGEN  |  | JAC8A08CA    |          |
|---|--|--------------|----------|
| APLICACIÓN  |  | EQUIVALENCIA |          |
| PASSAT 1998-2001 4C 1.8L TURBO / PASSAT 1998-2001 6C 2.8L / |  | CFI8110      | FRAM     |
|   |  | CFI-8A08CA   | INTERFIL |
|   |  | 24774        | WIX      |

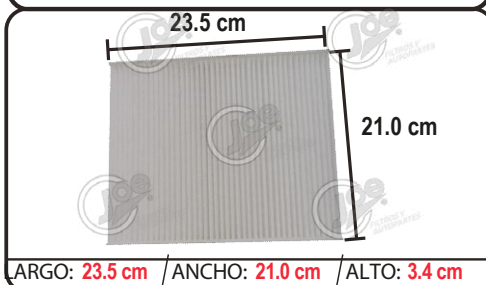

| VOLVO                           |  | JAC1354        |          |
|---------------------------------|--|----------------|----------|
| APLICACION                      |  | EQUIVALENCIA   |          |
| VOLVO C30 MOD. 2007-2010 5 CIL. |  | CF10375        | FRAM     |
|                                 |  | CFI-1354       | INTERFIL |
|                                 |  | 49354 / WP2094 | WIX      |

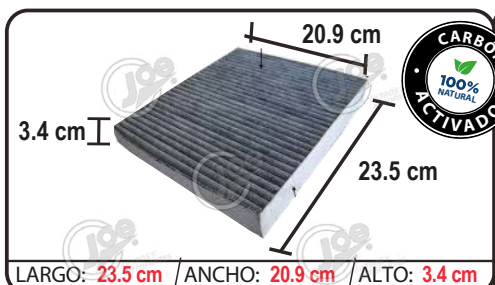

| VOLVO                           |  | JAC1354CA    |          |
|---------------------------------|--|--------------|----------|
| APLICACIÓN                      |  | EQUIVALENCIA |          |
| VOLVO C30 MOD. 2007-2010 5 CIL. |  | CF10375      | FRAM     |
|                                 |  | CFI-1354     | INTERFIL |
|                                 |  |              | WIX      |

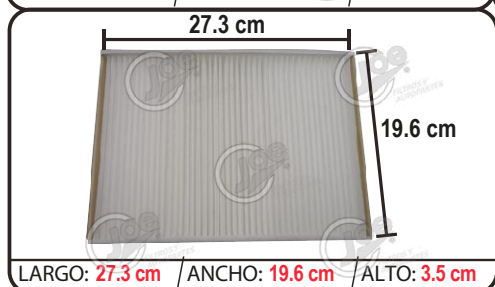

| VOLVO  |  | JAC1805      |          |
|--|--|--------------|----------|
| APLICACIÓN   |  | EQUIVALENCIA |          |
| S60 2014-2015 4C 2.0L TURBO DIESEL / S60 2012-2015 5C 2.5L TURBO / S60 2012-2015 6C 3.0L / S80 2015 4C 2.0 TURBO DIESEL / S80 2008-2015 6C 3.0L / S80 2008-2014 6C 3.2L / S80 2007-2010 8C 4.4L / V60 2015 4C 2.0L TURBO DIESEL / V60 2015 5C 2.5L TURBO / V60 2015 6C 3.0L / V70 2008-2010 6C 3.2L / XC60 2015 4C 2.0L TURBO DIESEL / XC60 2010-2015 6C 3.0L TURBO / XC60 2010-2015 6C 3.2L TURBO / XC70 2015 4C 2.0L TURBO DIESEL / XC70 2009-2015 6C 3.0L TURBO / XC 70 2008-2015 6C 3.2L TURBO / |  | CF10442      | FRAM     |
|  |  | CFI-1805     | INTERFIL |
|  |  | 49355        | WIX      |

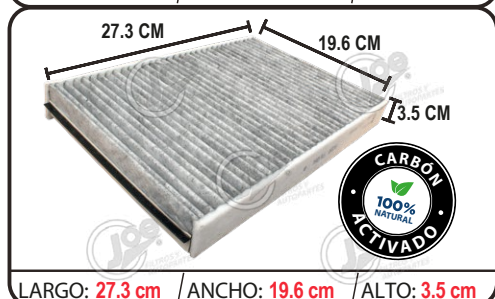

| VOLVO  |  | JAC1805CA    |          |
|--|--|--------------|----------|
| APLICACIÓN   |  | EQUIVALENCIA |          |
| S60 2014-2015 4C 2.0L TURBO DIESEL / S60 2012-2015 5C 2.5L TURBO / S60 2012-2015 6C 3.0L / S80 2015 4C 2.0 TURBO DIESEL / S80 2008-2015 6C 3.0L / S80 2008-2014 6C 3.2L / S80 2007-2010 8C 4.4L / V60 2015 4C 2.0L TURBO DIESEL / V60 2015 5C 2.5L TURBO / V60 2015 6C 3.0L / V70 2008-2010 6C 3.2L / XC60 2015 4C 2.0L TURBO DIESEL / XC60 2010-2015 6C 3.0L TURBO / XC60 2010-2015 6C 3.2L TURBO / XC70 2015 4C 2.0L TURBO DIESEL / XC70 2009-2015 6C 3.0L TURBO / XC 70 2008-2015 6C 3.2L TURBO / |  | CF10442      | FRAM     |
|  |  | CFI-1805     | INTERFIL |
|  |  | CFI-1805     | WIX      |

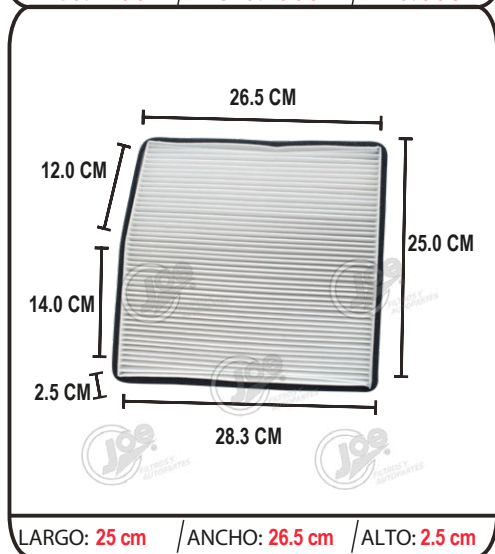

| VOLVO   |  | JAC3063      |          |
|---|--|--------------|----------|
| APLICACIÓN  |  | EQUIVALENCIA |          |
| C70 2001-2003 5C 2.3L TURBO / C70 2001-2004 5C 2.4L TURBO / CROSS COUNTRY 2001-2003 5C 2.3L TURBO / CROSS COUNTRY 2001-2003 5C 2.4L TURBO / CROSS COUNTRY 2001 6C 2.9L / S60 2001-2004 5C 2.3L TURBO / S60 2001-2005 5C 2.4L / S60 2001-2005 5C 2.4L TURBO / S60 2003-2009 5C 2.5L TURBO / S60 T5 2007 5C 2.5L TURBO / S70 2001-2003 5C 2.3L TURBO / S70 2001-2003 5C 2.4 TURBO / S70 2001 5C 2.9L TURBO / S80 2004-2006 5C 2.5L TURBO / S80 1999-2001 6C 2.8L TURBO / S80 1999-2004 6C 2.9L / S80 2002-2005 6C 2.9L TURBO / S90 1996-1998 6C 2.9L / V70 2001-2004 5C 2.3L TURBO / V70 2001-2007 5C 2.4L / V70 2001-2005 5C 2.4L TURBO / V70 2003-2007 5C 2.5L TURBO / V90 6C 2.9L / XC70 2003-2007 5C 2.5L TURBO / XC70 2010-2011 6C 3.0L TURBO / XC70 2010-2011 6C 3.2L TURBO / XC90 2003-2006 5C 2.5L TURBO / XC90 2003-2005 6C 2.9L TURBO / XC90 2007-2014 2007-2014 6C 3.2L / XC90 2005-2001 6C 4.4L / |  | CF8718A      | FRAM     |
|   |  | CFI-3063     | INTERFIL |
|   |  | 24818        | WIX      |



## FILTROS Y AUTOPARTES JOE

VIOLETA #1132 COL. QUINTA VELARDE

GUADALAJARA, JAL. C.P. 44430

TEL: (01 33) 3619 6262 3650 2272 & 3619 4071

ventas@filtrosjoe.com  
filtrosjoe@gmail.com



VENTAS EN LÍNEA  
**33332 78986**



SERVICIO A CLIENTES  
**33 38744001**



@FiltrosJoe



FiltrosJoe

WWW.FILTROSJOE.COM